



Linear collection gas fireplaces

Operation guide

Rinnai

Important

Appliance must be installed with a Rinnai approved flue system.

This appliance must be installed in accordance with:

- Manufacturer's installation instructions
- AS/NZS 5601 Gas Installations
- AS/NZS 5263 Gas appliances standards

For use with Natural Gas or Universal LPG as indicated on the appliance.

Appliance must be installed, commissioned, serviced, and removed by an authorised person, being in New Zealand a licensed gasfitter.

Warning

Improper installation, adjustment, alteration, service and maintenance can cause property damage, personal injury or loss of life.

For more information about buying, using, and servicing of Rinnai appliances call: 0800 RINNAI (0800 746 624).

Rinnai New Zealand Limited
105 Pavilion Drive, Mangere, Auckland
PO Box 53177, Auckland Airport, Auckland 2150

Phone: (09) 257-3800
Email: info@rinnai.co.nz
Web: rinnai.co.nz
[youtube.com/rinnainz](https://www.youtube.com/rinnainz)
[facebook.com/rinnainz](https://www.facebook.com/rinnainz)

Contents

Safety	4
General information	5
About your Rinnai Linear gas fire	6
Operation using your remote	8
Operation using the Wi-Fi app	10
Clearances from combustibles	11
Mantels and surrounds	12
Abnormal flame pattern	13
Error codes	14
Troubleshooting	16
Installation checklist and installer details	18
Limited Warranty	19
Purchase details	21

Appendices

Appendix 1: Glass cleaning	22
Appendix 2: Filter cleaning	23

Servicing and serial number

Gas fires, like cars, require regular maintenance and servicing. For reliable operation Rinnai gas fires should be serviced **every two years**, including inspection of the flue system.

On the back of this guide is a serial number for your fire. You **must have** this to register your fire and use the app. We recommend taking a photo or noting it down, just in case you misplace your guide.

Safety

Important

This appliance is not intended for use by persons (including children) with reduced physical, sensory or mental capabilities, or lack of experience and knowledge, unless they have been given supervision or instruction concerning use of the appliance by a person responsible for their safety.

- The heater must not be used or operated if any part of the appliance is damaged
- Do not place articles on or against this appliance
- Do not use or store flammable materials near this appliance
- Do not spray aerosols in the vicinity of this appliance while it is in operation
- Do not modify this appliance
- The fire must not be located immediately below a power socket outlet (potential fire hazard)

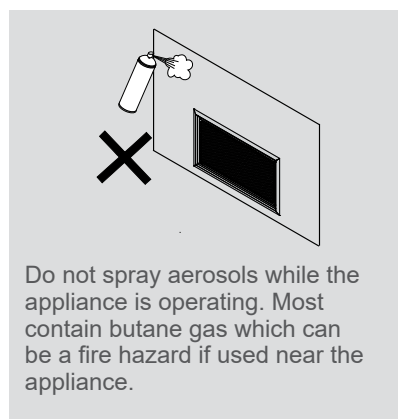
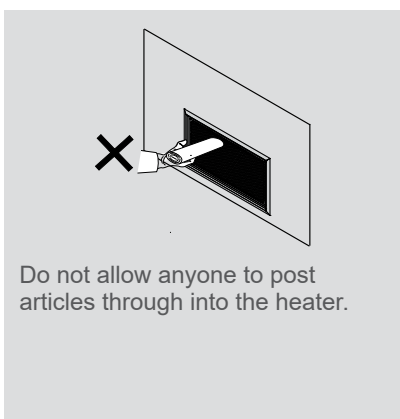
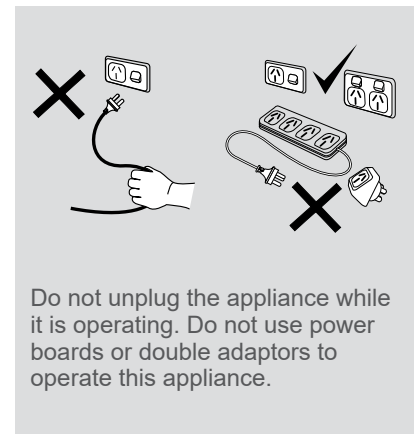
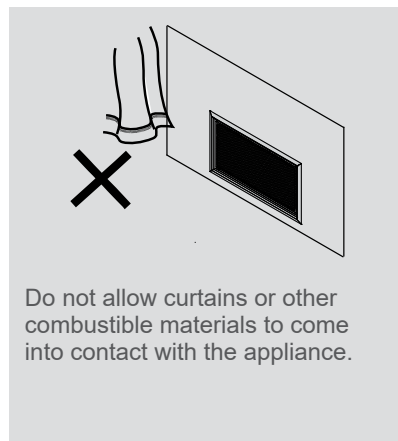
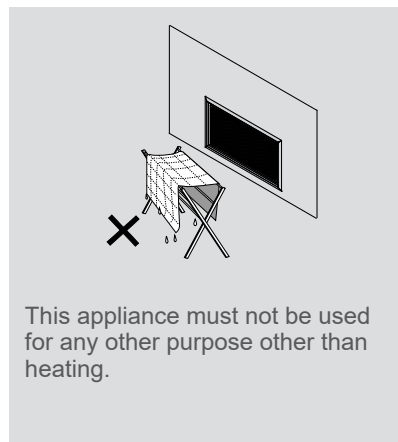
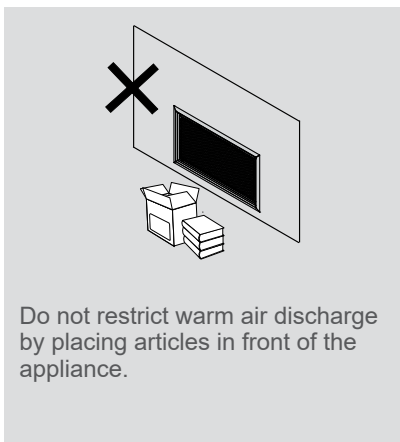

General information

Before operation please read these instructions to get an overview of how to operate, maintain and service your Rinnai gas fire.

Electrical connection

The Linear is fitted with a 1.5 m power cord and 3-pin plug. The power cord passes through a slot in the back right hand corner of the appliance.

The connection is either direct wired¹ or connected to a power point within the cavity. This must be connected to a dedicated earthed power point. The electric isolation switch must be accessible after the appliance has been installed.

Installation by a licensed tradesperson

Only a licensed tradesperson can install, adjust, maintain, service, and remove this gas fire. Any work carried out by a non-licensed tradesperson is illegal and will void any warranty.

Installer handover

Ensure your installer talks to you about the use and care of this appliance, and that you understand these instructions. The installer also needs to complete the appliance installation checklist and installer details (p.18), and leave this guide with you.

Safety devices

Your Rinnai Linear has the following safety devices; flame failure sensing system, pressure relief, overheat safety switch, air temperature sensor, thermal fuse, overcurrent fuse, and spark detection.

Soot deposits

Small soot deposits inside the heater or glass is normal. The inside of the glass can be cleaned, refer instructions on p.22. Significant soot build-up however is not normal and will require a service call. Refer to the troubleshooting section for further information.

Environmental

The Rinnai Linear is manufactured from a number of recyclable materials. At the end of its useful life please consider what parts could be recycled, for example scrap metal, PCB etc.



Care and maintenance

All external surfaces of the Linear can be cleaned using a soft damp cloth and mild detergent. Do not use solvents and do not attempt to clean while the Linear is still operating or hot.

Servicing

Rinnai has a maintenance, service and spare parts network with personnel who are fully trained and equipped to give the best advice on your Rinnai appliance.



Servicing and repair should only be carried out by authorised personnel, please call Rinnai (0800 746 624).

For reliable operation Rinnai gas fireplaces should be serviced every two years, including inspection of the flue system. If they are in a particularly dusty environment or subject to excess lint, for example dog hair, or where there are newly laid carpets, then annual servicing would be beneficial.

Regular maintenance and servicing is not covered by the Rinnai warranty.

Outside flue terminal

On cold days steam may be discharged from the flue terminal. This is normal for high efficiency appliances like the Linear and does not indicate a fault.

For those with a horizontal flue terminal, ensure you keep trees, shrubs, and any other obstructions well clear of the flue terminal.



¹ Consult a qualified electrician if direct wiring is required as it must comply with AS/NZS 5601 and AS/NZS 3000 and other relevant local regulations

About your Rinnai Linear gas fire

Congratulations on the purchase of your Rinnai Linear gas fire. We hope you love this product as much as we do, and on the off chance that something does go wrong, or if you need help, we're only a phone call away.

Manual control button

On/Off button—lower left hand side on the INSIDE of the frame.



Control options
Infra-red remote
and Wi-Fi control

Internal Wi-Fi reset

A narrow reset tab sits INSIDE the frame to reset the Wi-Fi module (p.15).

Infra-red remote receiver window and ignition indicator

Will beep when it receives a signal from the remote and flash green during the ignition process.

Please note: The receiver window position will vary slightly between models and single and double-sided variants. If in doubt the window is easy to identify as it will appear as a shiny section between the lips of the fire.

Infra-red remote or Wi-Fi control

Use the remote for basic control options or utilise the fully functional Wi-Fi app that allows for thermostatic control, and timer operation.

- [Infra-red remote](#)
The remote emits an infra-red signal. It must be aimed at the receiver window. Normal operating range is up to 7 m. Please note; range can be affected by the angle at which you are aiming the remote. Some fluorescent lights may interfere with the transmission of the remote signal—change your operating position if this occurs.
- [Rinnai Wi-Fi app](#)
Available from the Apple App store (iPhone) or Google Play (android devices), refer p.10.

How the Rinnai Linear models start

Ignition sequence:



1. When the On/Off button is pressed, the infra-red receiver window will pulse green.
2. The combustion fan will start several seconds before the fire ignites, to purge the combustion chamber before the gas flows.
3. The ignition sparker will operate, and as soon as a spark is sensed gas will flow to the pilot burner, and then to the main burner.
4. When the main burner establishes a flame, the heater will automatically modulate between the burner settings to achieve and maintain the default set temperature of 22 °C¹.

Do not unplug or turn off the mains power supply to the fire as this will stop the convection fan from cooling down the unit. The convection fan operates for several minutes after the fire has been turned off.

Power cut or power disruption

If the power is disrupted while the Linear is operating, once the power has been restored, the fire will go into power failure mode, and 00 (mains power failure) will appear on your smart device.

To reset the fire, press the ON/OFF button on the control panel, remote control, or on the app, twice, to turn the fire back on.



Fault Code and Fix

00 **Probable Cause**
Mains power failure.

Description
When power failure is sensed operation stops.

Action
Reset heater, press the On/Off button at the fireplace twice.

Position of your Rinnai Linear on a wall

If installing the Linear up the wall in an elevated position, air from the convection fan, depending on the room configuration, could create draughts. This needs to be factored when determining the location of the fire.

Wall surface above the fire

The temperature of the wall surface directly above the appliance may get warm and discolour paint finishes or distort wall coverings. For durability of surfaces, please contact the manufacturer for their specification. The finish needs to be able to withstand temperatures of up to 65 °C above ambient.

¹ On initial start-up (no additional buttons pressed), the Linear modulates the flame and heat output to try and maintain the default temperature setting of 22 °C. If the room temperature starts to climb above 22 °C the Linear will modulate to its lowest flame and fan setting, but will not turn off. Depending on the size of the room this could mean the room temperature could steadily rise.

Operation using the remote

For the remote control functions to be available, the appliance On/Off button must be in the On position.

Signal transmission to the unit

The unit will beep and flash to confirm the settings have been received from the remote.

Lost or misplaced remote

If you misplace the remote the fire can still be used, albeit in a limited capacity¹, by using the power On/Off button on the lower left hand corner of the outer frame. The fire will automatically modulate between flame settings to maintain the default set temperature of 22 °C.

Remote - safety



Keep the remote away from young children. Also ensure they can't access the batteries—they can become a choke hazard and potentially life-threatening if swallowed.

Breakage of the plastic housing could expose sharp edges—replace the remote if this occurs.

Avoid getting the remote wet as water entry will damage the remote.

Batteries

The remote uses two Lithium cell CR2450 batteries. Never mix old and new batteries. The remote will be supplied with the batteries already inserted, pull the clear tab to activate (OH, meaning OK, will flash on the display). This will also occur when the batteries have been replaced.

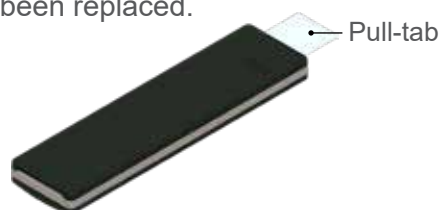

Remove the batteries if the remote is not going to be used for a long time. This will help avoid damage from leaking batteries. If leakage has occurred the remote will need to be replaced as leaking chemicals could be a risk if touched or ingested.

Changing the batteries

- **Remove the back**
Slide your fingernail under the bottom corner and along the base, and gently pry apart. With some coaxing the cover will pop off. Patience required, remember it's designed so little fingers cannot easily access the batteries.

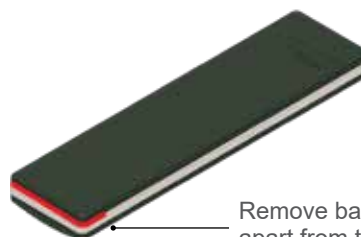

Remove back cover by prising apart from the bottom first

- **Unscrew the black retaining bridge**
Undo the two small screws holding the black retaining bridge between the two batteries.

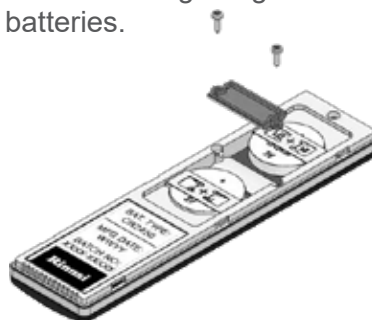

- **Replace the batteries**
The batteries can only be inserted one way—printed side facing up as shown on the next page. The battery contact edges can be sharp, take care when replacing the batteries.
- **Replace the black bridging plate**
Ensure you replace the black bridging plate as this will reduce the risk of young children getting access to the cell batteries.

¹ Only applies if you do not operate the Linear using the Wi-Fi app.

Flame and heat setting

Once the fire is turned on the flame setting defaults to level five (on high). Use the up and down buttons to control the height of the flame and heat output.

The relationship between the flame height and fan speed is preset and cannot be adjusted. The fire has five flame and fan settings:

Flame height	Fan speed
1	low
2	low
3	high
4	high
5	high



Turning on and off

This button switches the fire on and off. For it to work the power button on the fire must be ON.

Indicative room temperature display

Displays the room temperature* (at the point of the remote) and low battery symbol if the batteries need changing. 

The back light will stay on for approximately five seconds. Constant activation will shorten battery life.

* Checks the room temperature every minute.

N.B: Do not compare the temperature readings from the remote and the app. The readings are being taken from different places and could vary significantly.

Black retaining bridge

Safety device that needs to be removed before replacing the batteries—DO NOT DISCARD, this MUST BE put back on.



Battery retainer

Temperature sensor position

The temperature sensor is located in the bottom of the remote. Please be aware the sensor will be affected by direct sunlight, draughts, and body temperature (your hand).

Pry point for removing the back cover

Gently pry open the back cover from the base of the remote

Operation using the Wi-Fi app

For the Wi-Fi app to work on your fireplace, you will need to have downloaded the app from the Apple App store or Google Play. The phone will then be paired to the fireplace and then to your home Wi-Fi connection.

Wi-Fi app features

The Rinnai fireplace app will quickly and easily enable you to perform a number of different functions via your mobile device.

- **Turn on the thermostat function**
Set a comfortable temperature and let the fire do the rest.
- **Switch to flame function**
An override of the thermostat function that allows a full-flame picture regardless of the room temperature.
- **Turn on timers**
For those that love ultimate control, multiple timers can be set and changed for every day of the week.



For more information about how to use the Rinnai Wi-Fi app, refer to the 'Wi-Fi control user guide' available on the Rinnai website, www.rinnai.co.nz, enter Wi-Fi user guide in the search field.

Clearances from combustibles

The clearances listed below, measured from the edge of the glass, are minimum clearances unless otherwise stated.

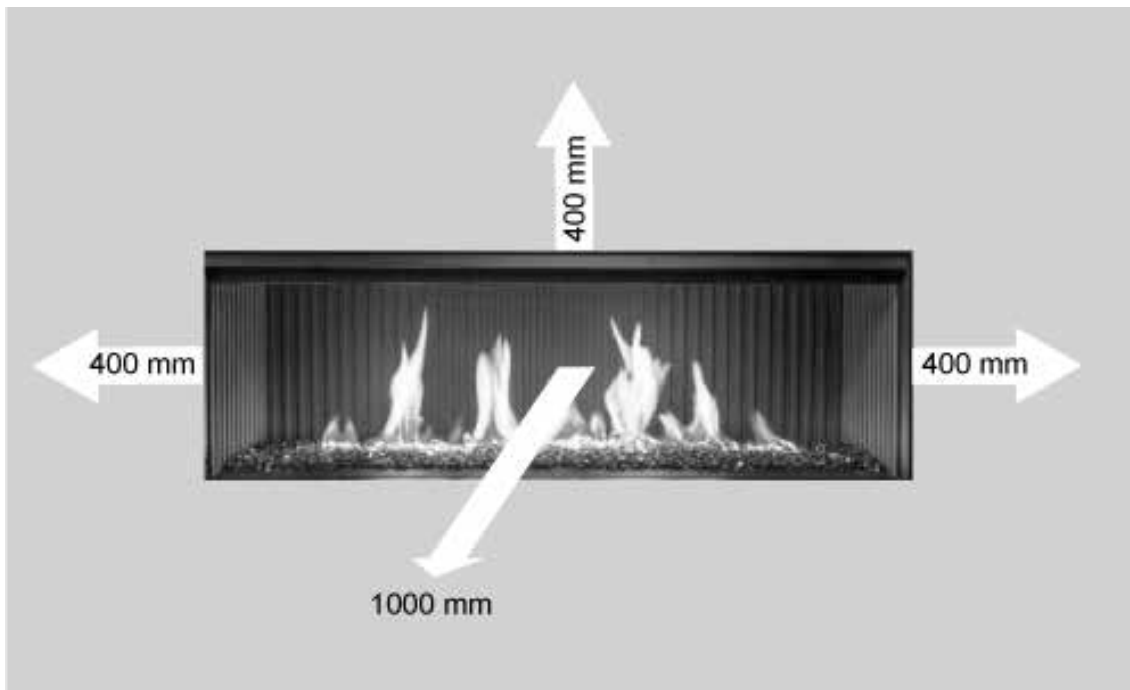

While the heater is operating

The appliance must not be installed where curtains or other combustible materials could come into contact with the fire. The 400 mm side clearance includes side walls. The 1000 mm clearance is in front of the fire.

Floor protection

Heat emanating from this fire may over time affect the appearance of some materials used for flooring, such as, carpet, vinyl, cork or timber. This may be amplified if the air contains cooking vapours or cigarette smoke. To avoid this occurring, it is recommended that a mat be placed in front of the appliance.

Hearths

A hearth is not necessary but can be used for decorative purposes or protection of sensitive flooring if required. The hearth, due to radiant heat from the fire, should be a non-combustible material and must not obscure the front of the fire or obstruct the fire in any way.

TV installation above the fireplace

Linear models have a fan that distributes warm air from the top of the appliance out into the room. As warm air is dispersed outwards and not directly upwards, installation of a TV may be an option.

Generally the bottom of the television should be at least 400 mm above the fire. Please check with the television supplier to check clearances. Some television manufacturers have warranty conditions that state a television is not to be installed above a fireplace.

For further information, please contact Rinnai or refer to the installation guide, which includes a TV installation diagram.

Mantels and surrounds

Combustible mantels and surrounds require clearance from the unit to minimise the risk of fire. Mantels and surrounds, made of combustible materials such as wood, are allowed providing they are outside the minimum clearances shown.

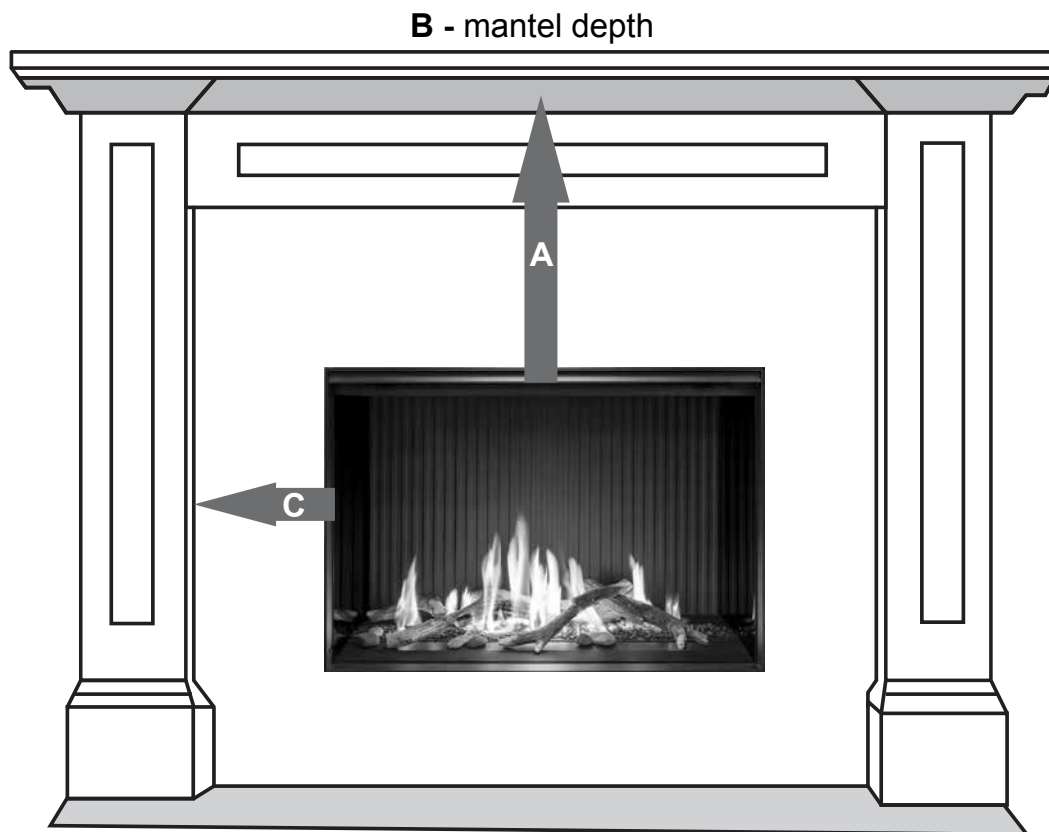

A	Mantel needs to be a minimum of 400 mm away from the edge of the glass
B	Maximum mantel depth at 400 mm (A) is 250 mm maximum
C	Surround needs to be a minimum of 400 mm away from the edge of the glass

For every 50 mm of added mantel depth there must be an additional 100 mm of clearance from the edge of the glass. For example:

Mantel depth A: clearance required

300 mm	500 mm
350 mm	600 mm
400 mm	700 mm

Abnormal flame pattern

Each Rinnai flame fire has a distinct flame pattern, refer images below. This should look the same every time you start your fire, after an initial warm up period of approximately 20 minutes.

Abnormal flame performance and/or pattern can indicate a problem with your fire, such as blocked gas injectors, or shifting of burn media. There are some warning signs that could indicate a problem:

- Unusual smell from the appliance
- Continued difficulty or delay in establishing a flame
- Either very short or very long flames
- Flame only burns part way across the burner
- Severe soot building up on the inside of the glass¹.

If any of the above signs occur, please contact Rinnai.

Your flame pattern should look like this (may vary slightly depending on gas type)

Linear 800 Flametech log set



Linear 800 standard log set



Linear 1000 log set



Linear 1000 modern media (glass)

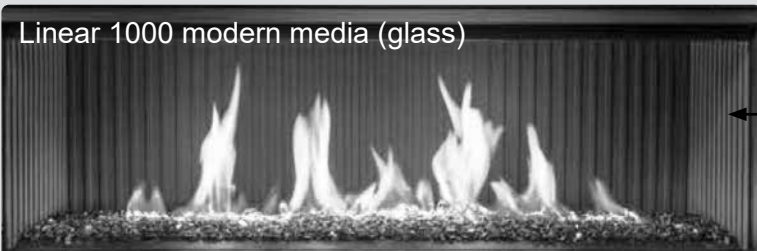

Linear 1500 modern media not shown, flame pattern will be the same as the 1000 model shown here

Linear 1500 log set



¹ Appliances incorporating a live fuel effect, and designed to operate with luminous flames, may exhibit slight carbon deposits—this is normal.

Error codes

The Linear has self diagnostic electronics that monitor the appliance during start up and operation. Should a fault occur the heater will shut down. The fault that has caused the shut down will be indicated, via the Wi-Fi app on your smart device.

Error code	Likely cause	Suggested solution
00	Mains power failure	Reset the fire, press the On/Off button on the control panel, remote control, or app twice, to turn the fire back on.
11	Ignition failure	Check the gas supply is turned on. Turn the heater OFF then ON again. If the problem continues a service call will be required.
12	Incomplete combustion	As above.
14	Overheat safety device	Filters may be blocked. Clean filters, refer p.23. If this does not sort the problem a service call is required.
16	Room overheat	Lower room temperature to below 40 °C.
31	Room temperature sensor faulty	Service call.
32	Overheat temperature 1 sensor faulty	Service call.
33	Overheat temperature 2 sensor faulty	Service call.
53	Spark sensor faulty	Service call.
61	Combustion fan motor faulty	Service call.
70	Model error	Incorrect PCB for model, service call.
71	Solenoids faulty	Service call.
72	Flame detection circuit fault	Service call.
73	Communication error	Service call.
90	Communication error detected between the main PCB and Wi-Fi module	Possibly requires a reset of the Wi-Fi module in the fire (next page), or on the app.
91	Communication error detected between smart device and Wi-Fi module	Check your Wi-Fi and Rinnai Wi-Fi module are within range. Check network settings.
92	Cloud function not currently available	This is due to another device having control on the home network, or the Wi-Fi module has gone offline.

Please note:

If you think your problem is Wi-Fi related, please lookup/download the Wi-Fi user guide available on the Rinnai website, enter Wi-Fi user guide in the search field. There may be a requirement for you to reset the Wi-Fi module in the fire. To do this for the Linear make sure the fire is on:

1. Grab a credit card, or something similar in thickness (non-metallic), and walk up to the fire.
2. Looking left of centre and down into the Linear you will see a narrow gap with a metal sheet.
3. Using your card, gently press down to reset the Wi-Fi module.
4. Restart your app and follow the instructions.

If this doesn't work, switch the power off (at the wall) and then back on again to reset the fire—try a couple of times if this doesn't work the first time.

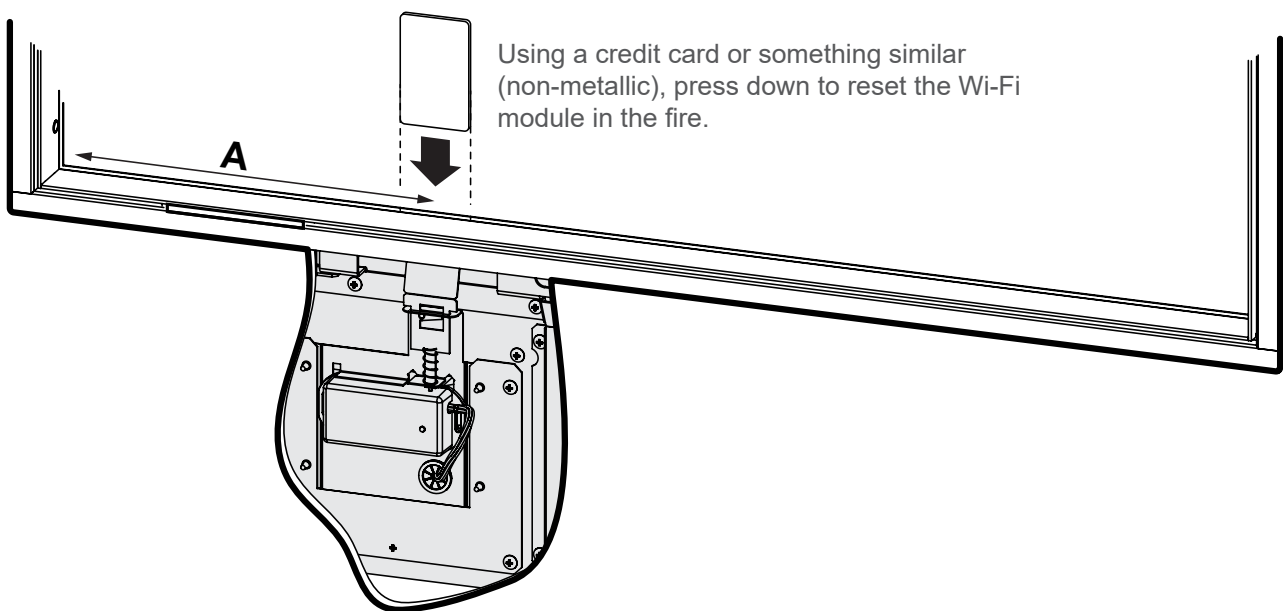

Approximate position of the Wi-Fi module from the left hand side of the fire—where the On/Off button is.

Wi-Fi reset position - A	
Linear 800	265 mm
Linear 1000	350 mm
Linear 1500	650 mm

Troubleshooting

Check the following information before making a service call as some performance characteristics of the fire are a normal part of operation. If you are still unsure or concerned after reading this section, please contact Rinnai on 0800 746 624.

During installation there will be an initial burning in period where some smoke and smell may be experienced, this could last for a couple of hours— this is a normal part of the operation.

The appliance is fitted with an overheat safety switch which will shut off the appliance. If the appliance shuts off repeatedly servicing may be required.

Using the heater for the first time, or after a long period of non use

Ignition may not occur the first time it is operated due to air in the gas pipes. If ignition does not occur the unit will switch off automatically. Try operating the heater again if this occurs.

The heater may make noises after ignition or switching off. This is due to the expansion and contraction of the internal components—this is normal. The heater will not ignite if the On/Off button is pressed straight after the heater has turned off. It will take approximately 20 seconds before the unit will switch on again.

What's happening	Explanation and/or possible solution
Unusual smells	
Smoke or strange smells are produced when first operating the appliance after installation.	This is caused by grease, oil, or dust within the appliance. This will stop after a couple of hours.
Smell of gas	Have you been painting? Have new carpets been laid? Have you been cooking with spices? If yes to any of the above, then this is normal as these odours will mix with the warm air to emit an unusual smell—this will dissipate over time. There could be a leak. Turn off the gas at the meter or LPG cylinder and call your installer.
Unusual sounds	
Clicking noises when the heater starts or stops, or changes to a higher or lower setting.	This is expansion and contraction of the heat exchanger and is a normal part of operation.
Clunking noise when the thermostat operates.	This is the sound of the gas valve opening and closing to regulate the flow of gas.
Soot marks and condensation on the glass	
Small soot deposit on logs or stones.	Normal operation, no action required.
Severe soot deposits forming on logs, stones, or glass	Inadequate flue system, incorrect gas pressure or incorrect installation of burn media. Contact a Rinnai Service Centre.
Condensation and/or water marks on the glass	Normal operation. Condensation should disappear once the fire has warmed up. If still a problem, the glass can be cleaned, refer p.22.

What's happening	Explanation and/or possible solution
Performance problems	
Warm air not coming from heater when it starts	The fan starts automatically after a short delay. This is to allow the appliance to warm up, helping avoid cold draughts.
Fan continues to run after the heater is turned off.	This is to remove residual heat from within the appliance. This stops once the unit cools down.
Fire will not light when switched on	Ensure the power cord is plugged in and turned on. Ensure gas supply is turned on.
Unit stops during operation	Possible power failure, or gas supply may have been turned off.
Unit is on low and the LED is on	Obstruction detected. Something may be too close to the warm air vent, remove and use the remote/app to resume normal operation.
Remote problems	
Remote control doesn't work	Unit not plugged in properly or has been turned off—plug in power cord or press On/Off button. Remote lock-up due to signal being out of range, incorrectly aimed at unit or obstructed.
No display on remote.	Batteries may be flat, change batteries.
Possible error codes* on remote when batteries are activated or changed:	
F1 displays on remote	Assembly fault, remote will not respond to movement—accelerometer not communicating with the main processor correctly. Contact Rinnai.
F2 displays on remote	Room temperature outside 5-45 °C, or temperature sensing circuit has failed, which may indicate an assembly fault. Contact Rinnai.

* Unlikely to occur, but possible if there has been an assembly fault or failure with the remote.

Installation checklist

The installer must complete the installation checklist below and make sure this guide is left with you. They must also instruct you about the use and care of the appliance, and ensure you understand the safety instructions.

Checklist

- Appliance positioned in a suitable location (clearances, mantels, surrounds, cavity ventilation).
- Room thermistor installed outside the fire box and into an area where room air will be drawn over it.
- Fire is fixed to the cavity with the provided seismic restraints.
- Rinnai flue system installed and tested to ensure effective draw. Dip switch changed to long flue if the flue length is greater than 3 m.
- Commissioned as per the commissioning instructions.
- Burn media installed as per instructions. FlameTech installation checked to ensure wire wool from log is not touching the flame rod.
- Appliance tested for correct operation and to ensure no gas leaks. This includes running on the high and low settings for over five minutes.
- Manual on/off button checked to ensure it is operational.
- Wall lining installed with required 3 mm air gap around the unit, and IR receiver is not painted, covered, or obstructed.
- Customer instructed on operating procedure (including Wi-Fi) and safety requirements.
- Customer advised to service the heater every two years.

Installer details

Company name:

Installer name:

Address:

Phone:

Mobile:

Certificate of compliance number for installation:

Signed:

Date:

Limited Warranty

Rinnai brings you peace of mind with a:

5-year firebox warranty



This warranty is applicable to all Rinnai Linear collection models. All terms of the warranty, subject to the conditions below, are effective from the date of first installation. The attending service person reserves the right to verify this by requesting a copy of the certificate of compliance prior to commencement of any warranty work. Proof of purchase and installation date will be required at the time of any warranty claim. This warranty is only valid within the country of purchase.

Any warranty claim must be made within a reasonable time of discovery of the potential fault or defect.

FIREBOX*		ALL OTHER PARTS	
Parts	Labour	Parts	Labour
5 years	2 years	2 years	2 years

* The firebox is the metal outer casing (as shown in the image to the right) that surrounds the fire. All other parts of the fire will be covered by a two year limited warranty.



General warranty terms

All Rinnai appliances meet or exceed the safety standards required by New Zealand gas and electrical regulations. The company is constantly improving its products and as such, specifications are subject to change or variation without notice.

For the purposes of the Consumer Guarantees Act 1993, Rinnai only guarantees the availability of repair facilities and spare parts for the express warranty period recorded in the table above.

This warranty does not limit any consumer rights or guarantees that may apply under the Consumer Guarantees Act 1993. If the product is acquired for the purposes of a business, the provisions of the Consumer Guarantees Act 1993 do not apply and no other warranties (either express or implied by law) apart from those stated in the warranty will apply.

Warranty terms and conditions

1. All terms of this warranty are effective from the date of first installation. The attending service person reserves the right to verify this by requesting a copy of the certificate of compliance prior to commencement of any warranty work. The installer must issue a certificate of compliance by law in New Zealand. Warranty claims may be invalid if not accompanied by details of the installing or supervising gas fitter's registration number and the gas certification number.
2. All Rinnai appliances must be installed, commissioned, serviced, repaired and removed in accordance with the manufacturer's installation instructions, local regulations, and building codes by persons authorised by local regulations to do so.
3. All appliances must be operated and maintained in accordance with the manufacturer's operating instructions. Rinnai recommends that gas appliances are serviced as per our servicing statement on p.5.

Warranty terms and conditions continued

4. Servicing of the product is to be carried out by a Rinnai authorised service centre.
5. The warranty applies only to the components supplied by Rinnai. It does not apply to components supplied by others, such as electrical switches, electrical cables, fuses and where applicable flue systems, but is not limited to these.
6. Where a failed component is replaced under warranty, the balance of the original warranty will remain effective.
7. Rinnai reserves the right to transfer functional components from defective appliances if they are suitable.
8. Rinnai reserves the right to have installed product returned to the factory for inspection.
9. Where the gas fire is installed outside the metropolitan area or further than 40 km from a Rinnai authorised service centre, travel costs shall be the owner's responsibility.

Warranty exclusions

The following exclusions may cause the warranty to become void and will result in a service charge and cost of parts (if required).

1. Accidental damage, defects or failure caused by acts of God, fire, wind, lightening, flood, storm, hail storm fallout, vandalism, earthquake, war, civil unrest, misuse, abuse, negligence, pests, animals, pets, insects, or entry of foreign objects or matter into the product such as dirt, debris or moisture.
2. Failure due to abuse or misuse, improper maintenance or improper storage.
3. Failure due to incorrect or unauthorised installations including but not limited to the use of products, including flue systems, that are not specified by Rinnai, damage caused by installation of indoor fires outdoors and outdoor fires indoors.
4. Failure or damage caused by alterations, service or repair work carried out by persons other than Rinnai service persons or service centres.
5. Where it is found that there is no fault with the appliance and the issue is related to the installation or is due to the failure of electric or gas supplies.
6. Noise caused by minor contraction, movement or expansion of certain parts.
7. Cost of building work to access parts that need repair or replacement, or the costs of building repairs afterwards.
8. Subjective issues such as noise or smell that Rinnai have investigated (or a Rinnai service agent has investigated) and are established to be within normal operating parameters.
9. Variances in fireplace appearance, including flame picture, from Rinnai promotional images that are due to gas type, printing confines, and on-screen display variances.

Purchase details

Record your purchase details below

ATTACH YOUR PROOF OF PURCHASE HERE: 

Retailer: _____

Retailer address: _____

Date of purchase: _____

Product details: _____

Please keep these details in a safe place for future reference.

Register your Linear online

Register your Linear online at www.rinnai.co.nz/register/. You'll need to know the model, and also the serial number—shown on the sticker on the back page of this guide.

Warranty claim

Please contact Rinnai as soon as possible after the defect and/or fault has been detected.

To make a warranty claim, contact Rinnai on 0800 RINNAI (0800 746 624) or email info@rinnai.co.nz.

Appendix 1

Glass cleaning

The inside of the glass, over a period of time, may develop some buildup and condensation marks. These can be removed using a soft microfibre cloth, never use solvents or abrasive chemicals.



Do not attempt to clean the glass while the Linear is operating or is still hot. Before starting make sure the power to the fire is off and the glass is cool to touch.

Ensure the glass is on correctly before turning the Linear back on. NEVER operate the Linear without the glass in place.

DO NOT touch or adjust the burn media. Adjustment can only be done by a licensed gasfitter as burn media positioning is critical to the safe operation of the fire.

If you are attempting to clean the larger Linear units (1000, 1500), make sure you have an extra pair of hands available to help lift the glass out.

The glass front sits in a narrow channel at the bottom of the fire and is held in place by glass latches positioned at the top, on either side of the unit (the 1500 model has an extra glass latch in the center).

To remove the glass:

1. The louvre, as shown below, holds the glass in place. To remove tilt and rotate the bottom edge out, and remove—put the louvre to one side.
2. Push the top glass retainer latches up and slightly to one side to release the top section of the glass.
3. Using the frame tabs at the top of the glass frame, lift up and gently slide to the right and rotate the glass until the left section comes free, then move the glass panel to the left to remove the right section.
4. Clean the glass, using a soft microfibre cloth, and reinstall by following the above steps in reverse order.

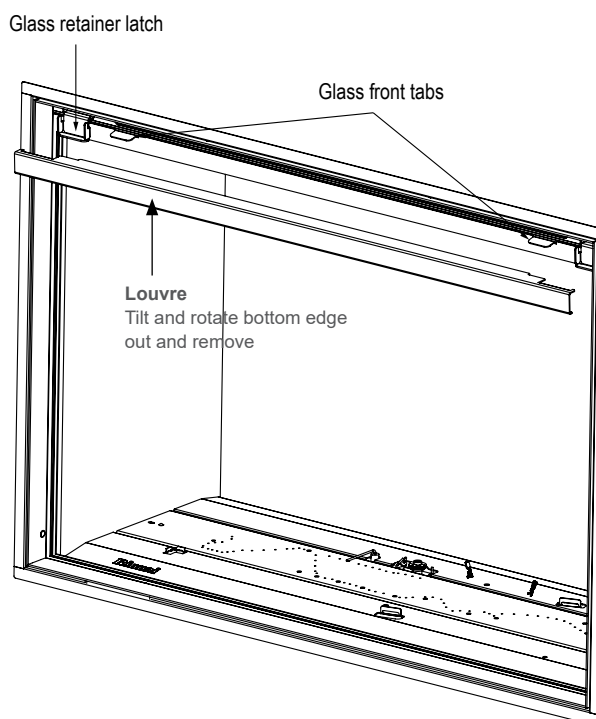
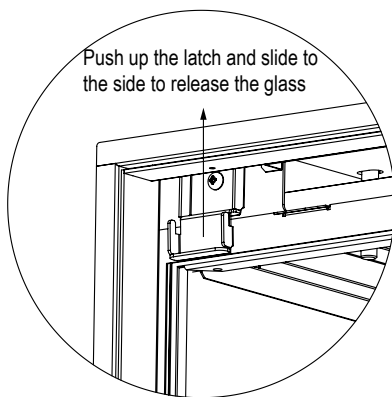

Appendix 2

Filter cleaning

To protect the appliance from dust or lint, two filters are fitted in front and to the right of each Linear model, refer image below. If the filters become blocked, error code 14 (overheat safety device) may show on your smart device.

The build up of dust on the filters reduces the air flow through the unit. This reduces the fire's efficiency and can lead to an error code and the fire shutting down. Regular (weekly) filter cleaning during the heating season will stop this from happening.

- Do not remove the filters while the fire is operating
- Wait for the fire to cool down before removing the filters



Ensure the filters are fitted back into the unit after cleaning. DO NOT operate the fire without the filters in place.

To remove the filters

Use the below image as a guide to locate the position of the filters. You will need to reach down into the fire to get them out. Place a finger either side of the filter and pull out. Do the same with the second filter.

Clean the filters using a soft brush, cloth, or vacuum.

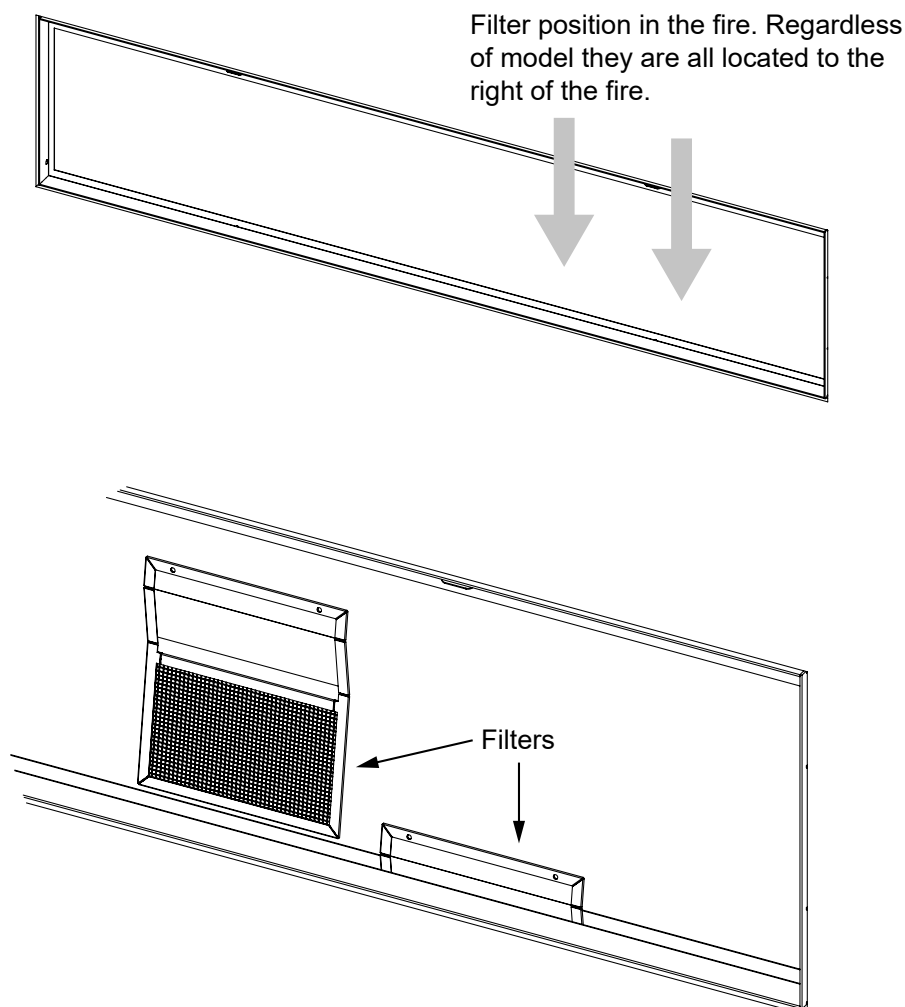

Rinnai.co.nz

Tel: 0800 746 624

<http://www.youtube.com/rinnainz>

<http://facebook.com.rinnainz>

Serial number / Wi-Fi code

Linear operation guide: 13562-F