

Rinnai Touch Wi-Fi Kit

Installation & Configuration Manual

APPLY MODULE
IDENTIFICATION LABEL

Rinnai

HOME OWNER TO RETAIN FOR FUTURE REFERENCE

Congratulations on the purchase of a Rinnai Touch Wi-Fi Kit that is compatible with Rinnai and Brivis home comfort systems, specifically Ducted Gas Heating, Dual Comfort (Add-On Refrigerated Cooling) or Evaporative Cooling systems with Wired Networker Controller.

Important Note

Read this manual carefully before installing or operating your Wi-Fi Module. Make sure to save this manual for future reference.

For reliable connection to the Wi-Fi module, router firmware and smart device software should be the latest version.

Terms and Conditions

The Terms and Conditions are available when downloading the Rinnai Touch App used to connect with the Wi-Fi Module. Please read these carefully before proceeding.

Disclaimer

IMPORTANT NOTICE: This document is a guide only. Laws, regulations and industry standards can vary between States and Territories. Accordingly, this guide must be read in conjunction with, and subject to, all laws, regulations and industry standards applicable in the State or Territory in which the products are installed. You must ensure that the installation of the products will comply with those laws, regulations and standards, and that the products recommended to customers are fit for the purpose for which they are intended.

Privacy Notification

Rinnai Australia Pty Ltd will collect personal information when warranty and maintenance registration forms are completed.

This personal information is collected under the guidance of the Privacy Information Protection Act 1998.

The purpose of collecting this information is to:

- process customer requests for us to provide service activities;
- register purchases of equipment for warranty;
- register requests for a survey/quotation for heating, ventilation, and air conditioning goods and services.

The intended recipients of the information are:

- employees of Rinnai.
- federal and state governments who may require the information for administration purposes.

While the supply of the information is voluntary, if our customers cannot, or do not wish to provide the information sought, the company may not be able to provide the services requested. If information has already been provided, an application can be made for access or amendment of that information, or to request that it not be used. Customers have a right of access to, and correction of, the information concerning them in accordance with the relevant procedures under the Act.

Enquiries concerning this matter can be addressed to the Business Practices Officer using the “Contacts” on page 24.

With our policy of continuous improvement, we reserve the right to change, or discontinue at any time, specifications or designs without notice.

Pictures for illustration purposes only.

All rights reserved. No part of these documents may be used in any way or form without prior written consent from Rinnai Australia Pty Ltd.

™ iOS is a trademark of Apple Inc.

™ Android is a trademark of Google LLC.

WARNINGS AND IMPORTANT INFORMATION



READ ALL INSTRUCTIONS BEFORE USING.

Always comply with the following precautions to avoid dangerous situations and to ensure optimum performance.

Failure to carefully read and follow all instructions in this manual can result in equipment malfunction, property damage, personal injury and/or death.

DANGER: Indicates an imminently hazardous situation which, if not avoided, will result in personal injury or death.

WARNINGS: Indicates a potentially hazardous situation which, if not avoided, could result in personal injury or death.

CAUTIONS: Indicates a potentially hazardous situation which, if not avoided, could result in minor or moderate injury or damage to the appliance. It may also be used to alert against unsafe practices.



WARNING.

The Rinnai Touch Wi-Fi Module is supplied with a 12V DC Plug Pack Socket if required. Only this power supply must be used.

The Module must be installed indoors only. Installation must be performed by a qualified person and in accordance with local and national wiring laws.

The Module is **NOT** intended for use by persons (including children) with reduced physical, sensory or mental capacities, or lack of experience and knowledge unless they have been given supervision or instruction concerning use of the appliance by a person responsible for their safety.

Children should be supervised to ensure that they do not play with the appliance.

If any cables are damaged, they shall be replaced by the manufacturer or its service agent or similarly qualified person in order to avoid a hazard.

Stranded conductors shall not be consolidated by lead-tin soldering where they are subject to contact pressure.

TABLE OF CONTENTS

BASIC INFORMATION	6	CHANGING Wi-Fi ROUTER	19
Kit Contents	6	OPERATING INDICATORS	21
Compatibility and Requirements	6	Wi-Fi MODULE ERROR CODES	22
Specifications	6	WARRANTY	23
Mounting the Module	6		
Touch Wi-Fi Module Front/Rear Panels	7		
Compatible Controllers	8		
INSTALLATION AND CONFIGURATION STEPS	9		
1 Rinnai Touch App Download & Install.....	9		
2 Positioning Your Touch Wi-Fi Module.....	10		
3 Wiring Your Touch Wi-Fi Module	12		
4 Configuring Your Touch Wi-Fi Module	14		
5 Touch Wi-Fi Module Detection by Rinnai Touch App.....	16		
6 Registering another Device	17		
7 Touch Wi-Fi Module Cloud Connectivity	18		

BASIC INFORMATION

KIT CONTENTS

- Touch Wi-Fi Module
- 12V DC Power Pack
- 20m Interconnecting Cable
- Screws, Plugs and Mini Screwdriver
- Unique Module Identification Labels
- This manual

COMPATIBILITY AND REQUIREMENTS

• Product Compatibility

Home Comfort Systems: Rinnai/Bravis Ducted Gas Heating, Dual Comfort (Add-On) or Evaporative Cooling system.

• Existing Wired Networker Controller

Rinnai/Bravis Networker Controller: N-C3, N-C6 or N-C7 Touch.

• Home System Requirements

Working Wireless Wi-Fi connection: 802.11b/g/n @2.4GHz (Security: WPA2) where applicable.

• Mobile Device

iOS 8 and Android 4.0.3 (API 15) or higher.

SPECIFICATIONS

- Standard: IEEE 802.11b/g/n
- Antenna Type: Internal
- Frequency: Wi-Fi 2.4GHz
- Operating Temperature Range: 0°C to 70°C
- Operating Relative Humidity: 10%–85%
- Power Input: DC 12V/300mA
- Module shall be within 10m of Wi-Fi Router

MOUNTING THE MODULE

After the optimum position for the Touch Wi-Fi Module is found, use the supplied screws to secure the backing plate to a truss within the ceiling cavity ready to clip onto the Touch Wi-Fi Module.

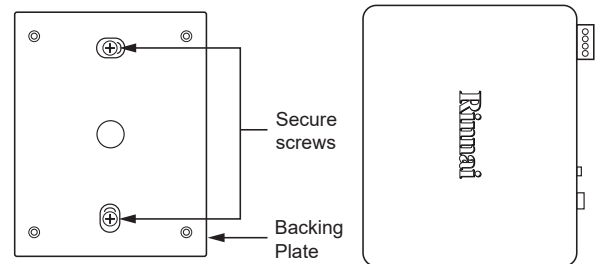

TOUCH WI-FI MODULE FRONT/REAR PANELS

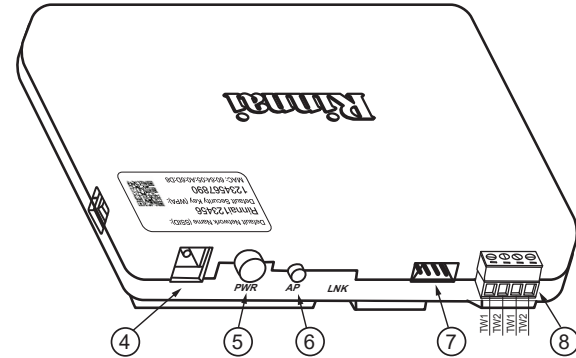
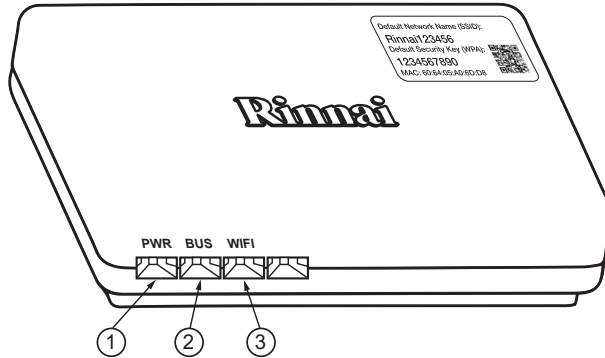

FRONT PANEL

1	PWR	Power on/Primary module operation indication.
2	BUS	Networker communication indication.
3	WIFI	Wi-Fi connectivity indication.

REAR PANEL

4	Plug-Pack Socket	Where needed the 12V DC plug-pack provided with the kit is to be plugged in here.
5	PWR	Power ON/OFF button to isolate power to the device
6	AP	Button used to force the Touch Wi-Fi Module into its configuration mode.
7	Alternative Power/ Two-Wire Bus Connection	Using the 20m interconnecting cable supplied with the kit this port can be used as an alternative to provide power and two-wire bus connection to the device. This is useful if the Touch Wi-Fi Module cannot be located close to a GPO.
8	Two-wire Bus Connection	Two-wire bus connection that allows connection to heating/cooling appliances, N-C3/N-C6 Networker controllers and N-T1 temperature sensors.

COMPATIBLE CONTROLLERS

NETWORKER CONTROLLERS N-C3 & N-C6



N-C7 TOUCH CONTROLLER



NETWORKER CONTROLLER N-C1



NETWORKER CONTROLLERS N-C2 & N-C4



INSTALLATION AND CONFIGURATION STEPS

1 RINNAI TOUCH APP DOWNLOAD & INSTALL



The Rinnai Touch App is needed to configure your Touch Wi-Fi Module so download and install it first.

Below are the QR codes to download the Rinnai Touch App from either the Apple Store or Google Play. If unable to scan the QR code, visit the appropriate App store and search 'Rinnai Touch' to locate and download it.

QR Code A - Android



QR Code B - iOS



Also available online from the Rinnai website www.rinnai.com.au is the Owner's Manual of the Rinnai Touch App. This provides further details regarding the functionality of the Rinnai Touch App and FAQ's.

The Touch Wi-Fi Kit contains three identical labels unique to the Wi-Fi Module.

- **Label 1:** Affixed to the Touch Wi-Fi Module.
- **Label 2:** Affixed to the front cover of this manual (home owner to retain for future reference).
- **Label 3:** It is recommended that this label be affixed to the backing plate of the Wired Networker Controller configured as the Master.

2 POSITIONING YOUR TOUCH Wi-Fi MODULE



Consider carefully where to locate your Touch Wi-Fi Module as Module/Router Wi-Fi signal range can be impacted by distance, obstacles and close proximity to other radio frequency sources.

DO

Locate the Touch Wi-Fi Module as close as possible to the Wi-Fi Router.

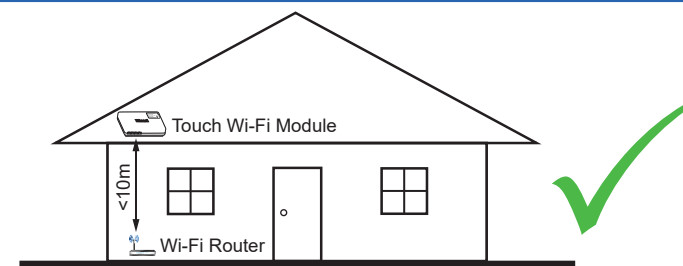

Centrally locate the Touch Wi-Fi Module if the Wi-Fi Router is at the end of the house.

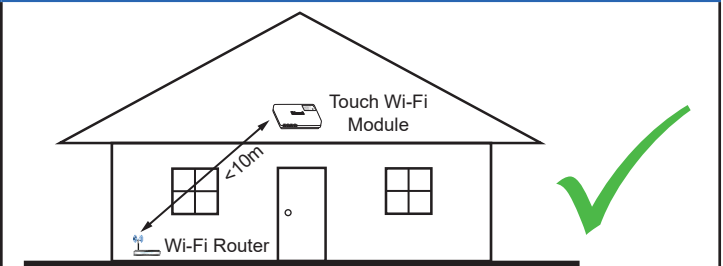

In the presence of other RF/Wi-Fi sources distance the Touch Wi-Fi Module away from them.

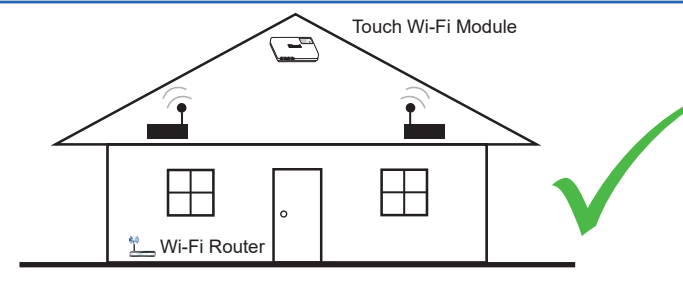

Where possible locate the Touch Wi-Fi Module so that its front panel indicators are visible from a man hole.

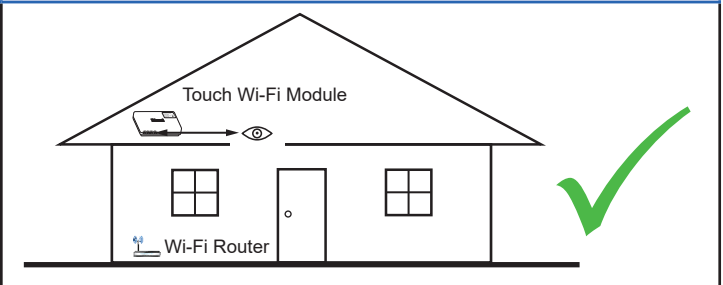

DO NOT

DO NOT locate the Touch Wi-Fi Module far away from the Wi-Fi Router.

DO NOT locate the Touch Wi-Fi Module inside a heater cabinet or any other form of metal cabinet.

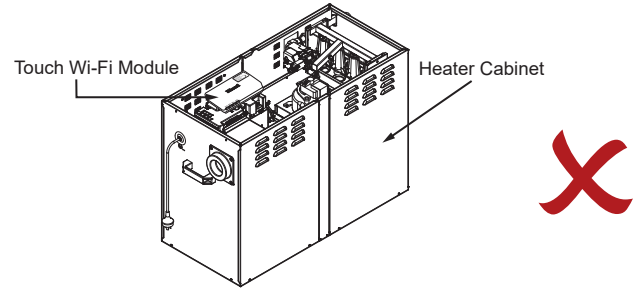
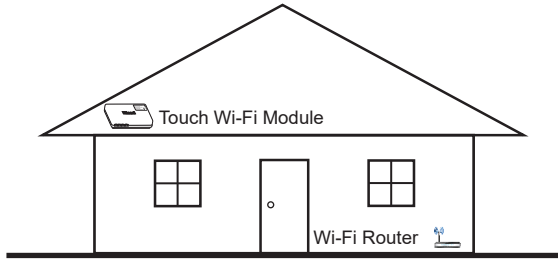

DO NOT locate the Touch Wi-Fi Module under the house.

DO NOT locate the Touch Wi-Fi Module outside the house.

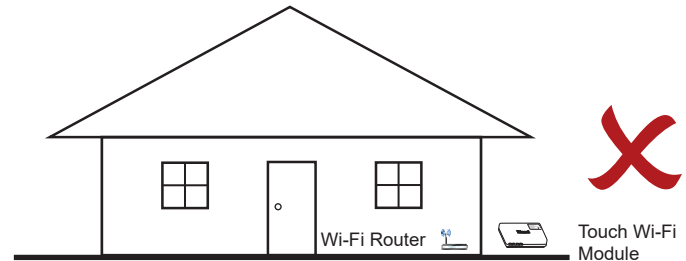
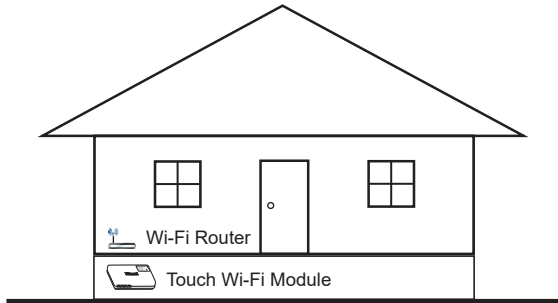

3 WIRING YOUR TOUCH WI-FI MODULE

N-C3/N-C6 NETWORKER BASED SYSTEMS

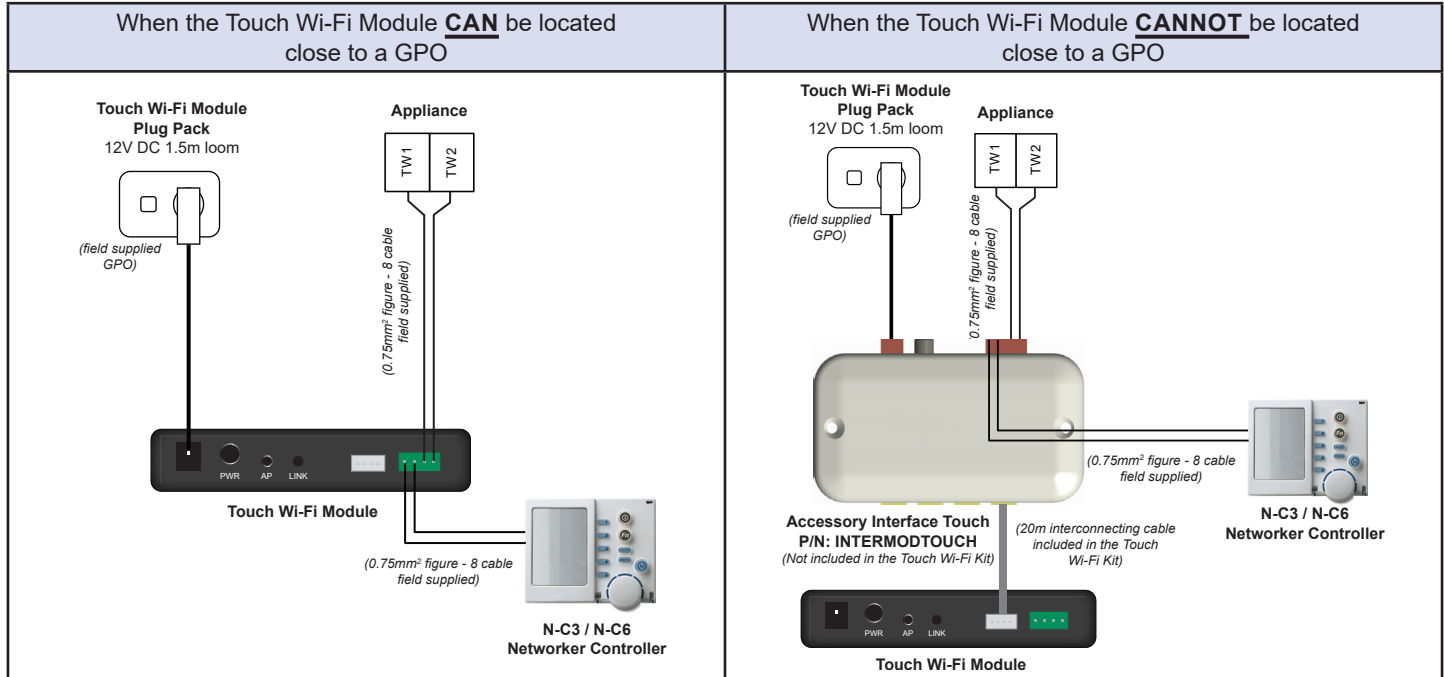

N-C7 TOUCH NETWORKER BASED SYSTEMS

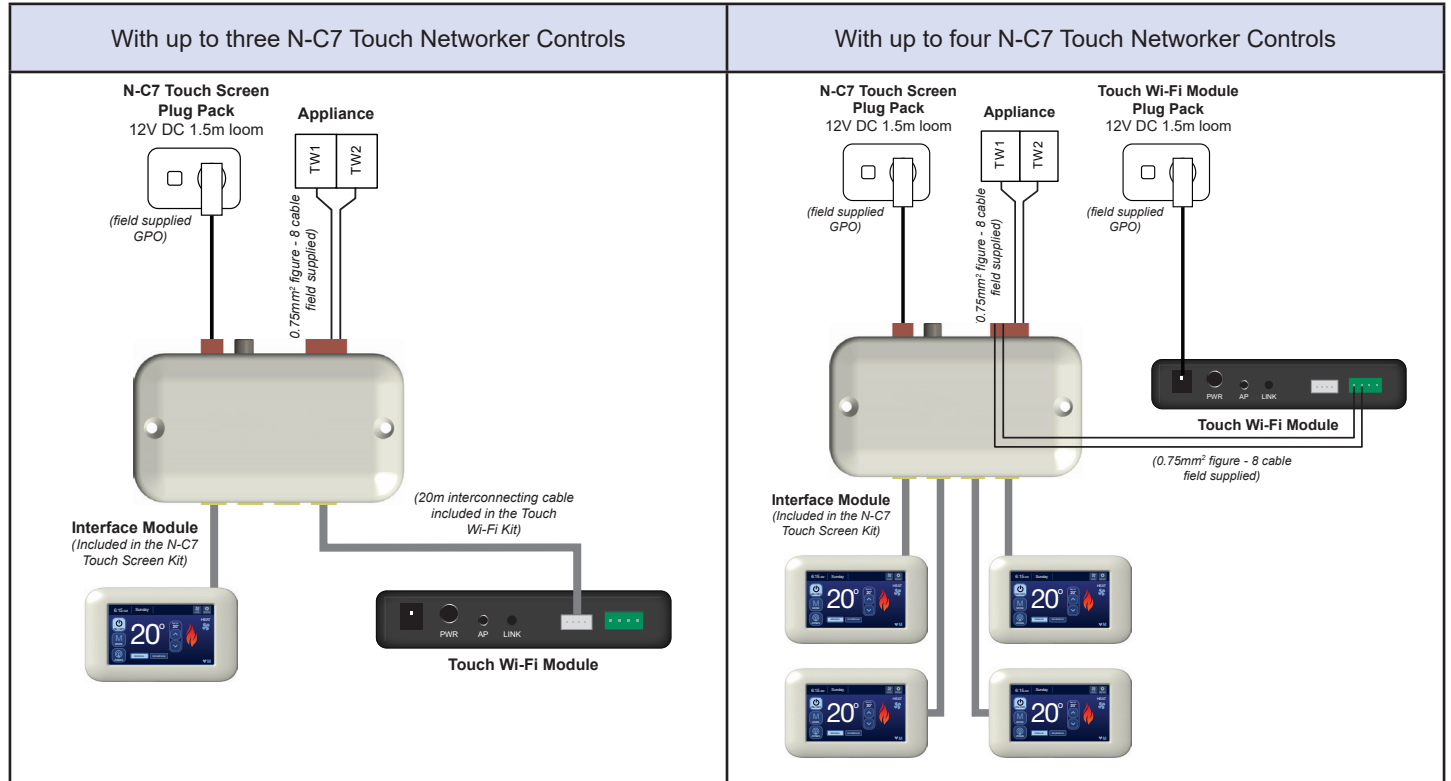

4 CONFIGURING YOUR TOUCH WI-FI MODULE

a. Your Touch Wi-Fi Module must be configured for connection to your Wi-Fi Router which can only be done when your Touch Wi-Fi Module is in its 'Configuration Mode' of operation. A Touch Wi-Fi Module operating in its configuration mode will have its Wi-Fi indicator flashing orange.

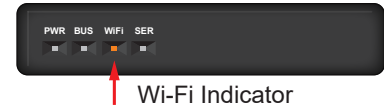

b. When the Touch Wi-Fi Module is in its configuration mode of operation it operates as a 'Wi-Fi Access Point' which a device can **directly** connect to. The credentials used for this Access Point operation are the Default Network Name (SSID) & Default Security Key (WPA) printed on a number of stickers that come with the Touch Wi-Fi Module.

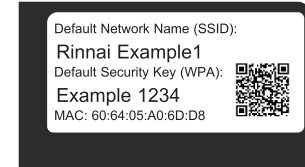

c. By default the Touch Wi-Fi Module **out of the box** should be operating in its configuration mode. If it is not, perform the following procedure to place the Touch Wi-Fi Module into its configuration mode:

- Ensure power is switched off to the Touch Wi-Fi Module using the 'PWR' button.
- **While** pressing the 'AP' button switch power on to the Touch Wi-Fi Module.
- Keep pressing the 'AP' button **until** the Wi-Fi indicator flashes orange.

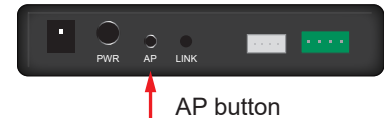

d. Next, run your Rinnai Touch App ensuring you **carefully** follow the on-screen prompts as these will guide you through the process of configuring your Touch Wi-Fi Module for connection to your Wi-Fi Router.



During the configuration procedure ensure you are within range of the Touch Wi-Fi Module as your device will need to connect directly via Wi-Fi to the Touch Wi-Fi Module to complete the configuration.



When navigating through the configuration process using the Rinnai Touch App, eventually a screen like that shown will be displayed that lists all the Wi-Fi Router SSIDs that have been detected by the Touch Wi-Fi Module along with a symbol indicating the strength of the Wi-Fi signal **as seen** by the Touch Wi-Fi Module.

Symbol Colour	Signal Strength
GREEN	Excellent
YELLOW	Good
RED	Poor (Possible Intermittent Connection)

- If the Wi-Fi Router SSID required is not listed then the Touch Wi-Fi Module could not detect it so the Touch Wi-Fi Module **must** be relocated.
- If the Wi-Fi Router SSID required is listed but with a RED symbol indicator then it is **recommended** to relocate the Touch Wi-Fi Module.



On relocating the Touch Wi-Fi Module ensure power is cycled to it as a scan of all available Wi-Fi Router SSIDs is **only** done by the Touch Wi-Fi Module on power up. The Touch App will also have to be restarted.

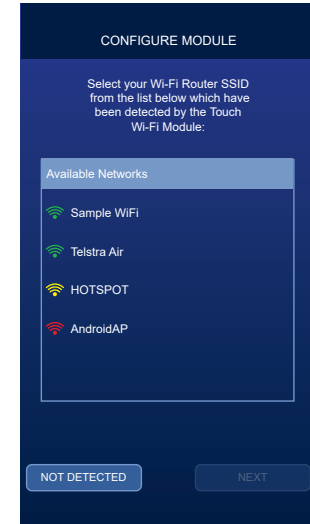

Once configured to connect to the chosen Wi-Fi Router the Touch Wi-Fi Module will have its Wi-Fi indicator flashing green.



A short duration blinking of the Wi-Fi indicator indicates the Touch Wi-Fi Module has connected successfully to the Wi-Fi Router selected.

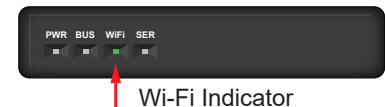

5 TOUCH Wi-Fi MODULE DETECTION BY RINNAI TOUCH APP

✓ On reaching this point of the configuration process your Touch Wi-Fi Module has successfully located and connected to your Wi-Fi Router as indicated by the short duration blinking of the Wi-Fi indicator. When the Rinnai Touch App successfully locates the Touch Wi-Fi Module on your Wi-Fi Network the  symbol will be displayed by the App.

? If the Rinnai Touch App **cannot** locate the Touch Wi-Fi Module on your Wi-Fi Network then possibly your Wi-Fi Router configuration settings need to be adjusted:

- To allow the Rinnai Touch App to locate the Touch Wi-Fi Module on your Wi-Fi Network the Touch Wi-Fi Module sends out at regular intervals what is known as a UDP broadcast packet which the Rinnai Touch App searches for.
- If for some reason the Rinnai Touch App cannot locate the Touch Wi-Fi Module on your Wi-Fi Network it is more than likely your Wi-Fi Router is blocking these UDP broadcast packets as a result of configuration settings within the Wi-Fi Router.
- If this is an issue with your Wi-Fi Router consult your Wi-Fi Router documentation to determine how to enable this function. At a bare minimum UDP broadcasts are to be allowed on **PORT 50000**.
- If this function is to be enabled based on a specific device look for the XXXX-**mysimplelink** description as this is the descriptor of the Wi-Fi device used within the Touch Wi-Fi Module. See example Wi-Fi Router configuration settings.



90E202833860-mysimplelink

Device Info | Parental Control | Port Forwarding | DMZ

Device Info

Friendly Name: 90:e2:02:83:38:60

Icon:  Miscellaneous

Location:

Hostname: 90E202833860-mysimplelink

6 REGISTERING ANOTHER DEVICE

On reaching this point of the configuration process your Touch Wi-Fi Module has successfully located and connected to your Wi-Fi Router and your device can access the Touch Wi-Fi Module using the Rinnai Touch App.

Any number of devices can register to connect with your Touch Wi-Fi Module, the process being as simple as just running the Rinnai Touch App on the device and following the prompts to allow the device to locate the Touch Wi-Fi Module on the Wi-Fi Network. When doing this:

1. Ensure your device is connected to your Wi-Fi Network.
2. Ensure **no other** device is currently Wi-Fi connected to the Touch Wi-Fi Module.



Only one device can be Wi-Fi connected to the Touch Wi-Fi Module at any one time.

7 TOUCH Wi-Fi MODULE CLOUD CONNECTIVITY

All that is needed to allow your device to access your Touch Wi-Fi Module via the cloud is to connect to your Touch Wi-Fi Module over your Wi-Fi Network once.

Once connected, the necessary Rinnai Cloud Server access credentials will be extracted from the Touch Wi-Fi Module and will be saved to the device. The  symbol will be displayed by the Rinnai Touch App when cloud connected to the Touch Wi-Fi Module.

In future, your device will not need to be connected to your Wi-Fi Network to access the Touch Wi-Fi Module.



NOTE

Any number of devices can be cloud connected to the Touch Wi-Fi Module at any one time.

CHANGING Wi-Fi ROUTER

You have changed your Wi-Fi Router and cannot connect to your Touch Wi-Fi Module such that the following screen is displayed by the Rinnai Touch App.

On changing the Wi-Fi Router the Touch Wi-Fi Module will need to be **reconfigured** so that it can connect to the new Wi-Fi Router with different SSID/WPA credentials. Select the “**Wi-Fi ROUTER REPLACED**” button to begin this process.

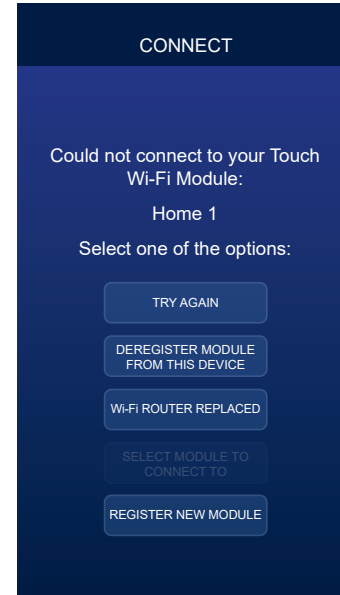

The Touch Wi-Fi Module must be operating in its configuration mode of operation so that it can be reconfigured according to Step 4 of the Installation & Configuration section – If you can **safely** access your Touch Wi-Fi Module, Step 4 describes how it can be manually put back into its **out of the box** configuration mode of operation.

TOUCH Wi-Fi MODULE NOT SAFELY ACCESSIBLE

The Touch Wi-Fi Module will **alternate** between its normal and configuration modes of operation when it **cannot** connect to the Wi-Fi Router it has been assigned to connect to. As this happens the Touch Wi-Fi Module will report an error code to the Master Networker Controller to indicate its operating mode.

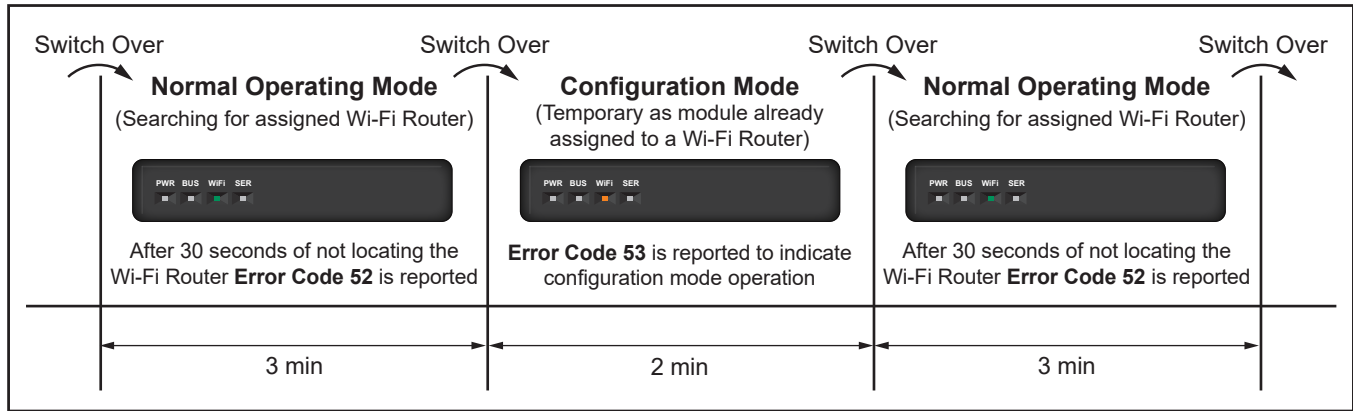

Look for Error Code 53 at your Master Networker Controller, which access is dependent on the type of controller installed:

- For an N-C7 Touch type controller, look for the icon  being displayed and upon pressing it the following message: “*Networker fault detected – Code#53*”.
- For an N-C6/N-C3 type controller, upon pressing the Fn1 key sequence look for the following message being scrolled across the screen: “*Sensor fault – n11 Code#53*”

Then follow Step 4 of the Installation and Configuration section to reconfigure your Touch Wi-Fi Module.



The Rinnai Touch App will step you through the above process when the Touch Wi-Fi Module not accessible option is selected.

OPERATING INDICATORS

Operating Indicators	Colour	Indication	Description
PWR	Power on/Primary module operation indication		
	Orange	Flash Fast Continuous	Primary module is saving operational/configuration settings to memory.
		Solid	Primary module is clearing the configuration settings to their default values.
	Green	Flash Fast Continuous	Primary module is loading configuration settings from memory.
Solid		Primary module is idle (indicates power on).	
BUS	Networker system communication indication		
	Green	Flash Once	When a Networker System communication packet has been received.
Wi-Fi	Wi-Fi Module operation indication		
	Orange	Flash Fast Continuous	Wi-Fi Module is saving configuration settings to memory.
			Wi-Fi Module is configuring itself for Default AP state operation due to AP push button being pressed (on power up).
		Flash Slow Continuous	Wi-Fi Module is in the Default AP state with no client associated with it.
		Flash Once	Wi-Fi Module is in the Default AP state and a packet transfer has occurred.
		Flash 'N' Times Repeatedly	Wi-Fi Module has experienced a fault, the number of flashes indicates the fault. Refer to Section 7 - Wi-Fi Module Error Codes table.
	Green	Solid	Wi-Fi Module is waiting for switch over to the Default AP state after being in the Router Mode with no connection to the named router occurring for 3 minutes.
		Flash Fast Continuous	Wi-Fi Module is loading configuration settings from memory.
		Flash Slow Continuous	Wi-Fi Module is in the Home Direct Mode with no client associated with it OR in the user configured Router Mode and not associated with the named router.
		Flash Once	Wi-Fi Module is in the Home Direct/Router Mode and a packet transfer has occurred.
Solid		Wi-Fi Module is waiting for switch over to the Default AP state after being in the Router Mode for at least 3 minutes without being able to connect with the named router.	

Wi-Fi MODULE ERROR CODES

The Touch Wi-Fi Module error codes will not disrupt operation of your appliance and may clear after some time. A list of possible error codes is given below:

Error Code	Wi-Fi Indicator Flashes	Description	Corrective Action
50	1	No configuration data detected.	Replace the module.
51	3	Touch Wi-Fi Module configuration error.	Check SSID/password entry otherwise replace the module.
52	3	The Touch Wi-Fi Module will try to connect to the assigned Wi-Fi Router for a duration of 3 minutes. If after 30 seconds the assigned Wi-Fi Router cannot be located this code is registered.	Check the Wi-Fi Router and check the distance between the Wi-Fi Router and Touch Wi-Fi Module.
53	N/A	The Touch Wi-Fi Module has switched over to its configuration mode as it could not locate the assigned Wi-Fi Router.	Look for this fault code when the Wi-Fi Router has been replaced and the Touch Wi-Fi Module cannot be safely accessed to manually put it back into its configuration mode.
54	N/A	The Touch Wi-Fi Module has been forced to operate in its configuration mode because it is yet to be configured.	The Touch Wi-Fi Module is yet to be configured to connect to a Wi-Fi Router and so will operate in its configuration mode until configured.
55	4	Internal Type 1 communication error.	This error will not allow the Touch Wi-Fi Module initial configuration or system access in-house. If the problem persists replace the Touch Wi-Fi Module.
56	5	Internal Type 2 communication error.	This error will not allow system access in-house. If the problem persists replace the Touch Wi-Fi Module.
57	2	Remote access error – Security type 1 error.	This error will not allow system access out of house. If the problem persists replace the Touch Wi-Fi Module.
58		Remote access error – Security type 2 error.	
59	6	Server type 1 configuration error.	This error will not allow system access out of house. If the problem persists replace the Touch Wi-Fi Module.
60	7	Server type 2 error.	This error will not allow system access out of house. If the problem persists replace the Touch Wi-Fi Module.
61	7	Server type 2 connection type 1 error.	This error will not allow system access out of house. If the problem persists replace the Touch Wi-Fi Module.
62		Server type 2 connection type 2 error.	

WARRANTY

WARRANTY: Rinnai Touch Wi-Fi Kit

This product is warranted for a period of one (1) year from the date of purchase, in accordance with the Terms and Conditions of Warranty detailed below.

IMPORTANT – TO BE READ IN CONJUNCTION WITH THE TERMS AND CONDITIONS OF WARRANTY

- The fitness for purpose of the Wi-Fi Kit and ensuring suitable Wi-Fi connectivity is the sole responsibility of the Qualified Installer and or Purchaser.
- The Wi-Fi Kit must be installed by a suitably Qualified Installer in accordance with local and national wiring codes, otherwise the warranty will be void.
- Always refer to the Installation and Owner's Manuals to ensure the correct installation and operation procedures have been followed.
- The Wi-Fi Module is to be installed indoors only; warranty excludes damage caused by the elements such as rain, wind, lightning, or harmful environmental conditions.
- Warranty on the Wi-Fi Kit is separate from the warranty on associated appliances, equipment and ancillary components.
- Before placing a warranty call, refer to the Troubleshooting Guide or FAQs listed in the Owner's Manual 'Connecting and Navigating the App' to assist in finding a resolution.
- For further information go to the Rinnai website, www.rinnai.com.au and follow the Wi-Fi links.

Rinnai Australia Pty Ltd

ABN 74 005 138 769 | AU45204

100 Atlantic Drive, Keysborough, Victoria 3173
P.O. Box 460, Braeside, Victoria 3195
Tel: (03) 9271 6625
Fax: (03) 9271 6622

National Help Line

Tel: 1300 555 545* Fax: 1300 555 655
Monday to Friday, 8.00 am to 5.00 pm EST.

**Cost of a local call higher from mobile or public phones.*

For further information visit **www.rinnai.com.au**
or email **enquiry@rinnai.com.au**

Rinnai has a Service and Spare Parts network with personnel who are fully trained and equipped to give the best service on your Rinnai appliance. If your appliance requires service, please call our National Help Line.

With our policy of continuous improvement, we reserve the right to change, or discontinue at any time, specifications or designs without notice.