

MODEL
CNTRLDRGINW

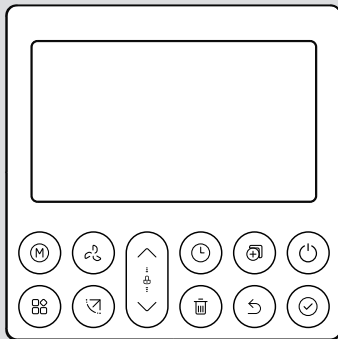

Standard wired remote controller

Operation and installation guide

Rinnai

Important

Controller must be installed in accordance with:

- Manufacturer's installation instructions
- Current AS/NZS 3000, AS/NZS 5141, AS/NZS 5419, AS/NZS 1677, and AS/NZS 60335.2.40
- HB276 - A Guide to good practice for energy efficient installation

Must be installed, maintained and removed only by an authorised person.

Warning

Improper installation, adjustment, alteration, service and maintenance can cause property damage, personal injury or loss of life.

For more information about buying, using, and servicing of Rinnai appliances call: 0800 RINNAI (0800 746 624).

Contents

Safety and important information..... 4

Installation 5

Controller operation

LCD display 12

Controller buttons 13

Operation..... 15

Timer functions 19

Fault codes 28

Wi-Fi control 29

Wi-Fi registration and connection 30

Safety and important information



DO NOT install the controller in a place exposed to leakage or flammable gases. Once flammable gases are leaked and left around the controller, fire may occur.

DO NOT operate with wet hands or let water enter the wired controller—electric shock may occur.

Controller must be wired according to the wiring diagram.

The wired controller operates in a low voltage loop circuit, DO NOT connect the cable to 220-240 V power.

The shielded wire of the wired controller **MUST BE** grounded.

After completing the wired controller connection, DO NOT use a megger tester to check the insulation. This may damage the product.

A maximum of TWO CONTROLLERS may be installed on a system.

Specification

Input voltage: DC 5 V / DC 12 V

Ambient temperature.: -5~43 °C

Ambient humidity: 40-90% RH

Controller loom shall be 2-core (0.5 mm²) shielded cable, up to 40 m.

Installation

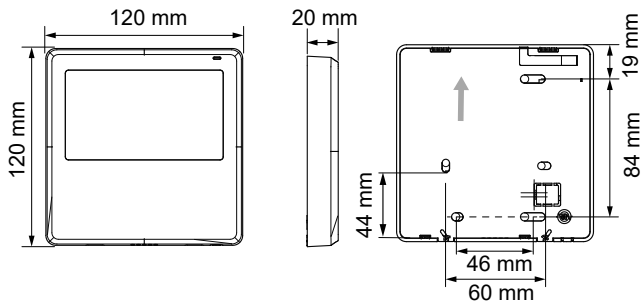

Backing plate

Remove the backing plate by inserting a flat screwdriver in the lower part of the controller, rotate (do not pry up and down) to remove the backing plate.

The PCB is mounted in the upper part of the controller be careful not to damage.

Fasten the backing plate on the wall with three screws (ST3.9*25) and plugs (provided).

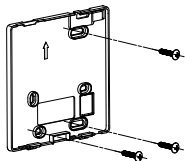
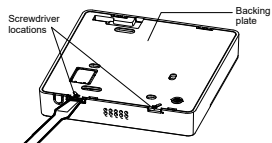

Loom access point

Remove plastic knockout from the backing plate.

Create a hole in the wall to access the wall cavity for routing the loom from the indoor unit to the controller.

Put on a flat surface. Be careful not to distort the back plate of the wired controller by over tightening the mounting screws.

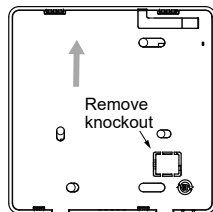

Battery installation (CR2032)



WARNING

Keep batteries out of reach of children.

Swallowing may lead to serious injury in as little as two hours, or death due to chemical burns and potential perforation of the oesophagus.

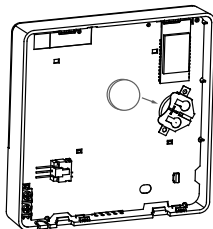

Slide the battery into the holder with the positive side facing up.

When first turning on set up the time of day. If the system is exposed to a power outage the battery will maintain the time of day. If the displayed time is not correct once power is restored try replacing the battery.

Thermostat connection to the indoor unit

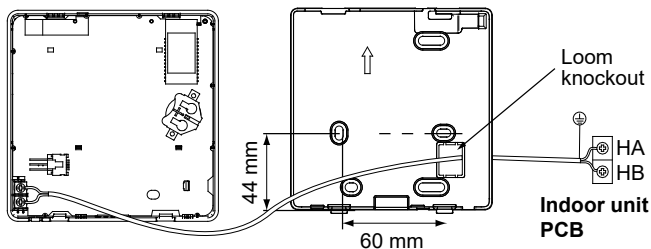

Indoor unit

Connect the terminals on the wired controller (HA, HB), and the terminals on the indoor unit (HA, HB). There is no polarity between HA and HB, refer image below.

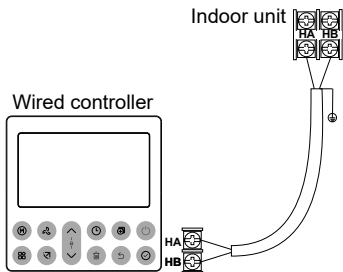

Setting up two controllers

Up to two controllers can be connected to the HA and HB terminals on the indoor unit as shown.

From the factory all controllers are supplied with SW1 dip switch setting 1 OFF and dip switch setting 2 OFF. When configuring a second controller, two dip switches on the rear of the second controller (SW1 location) must change to the ON position as shown. Dip switch settings for the primary controller must remain unchanged.

Controller 1 (primary)



Controller 2 (secondary)



If two controllers are installed both are equal and reflect the same information, and operational changes can be done on either controller. Wi-Fi control may be setup on one of the controllers only. There is no polarity between HA and HB.

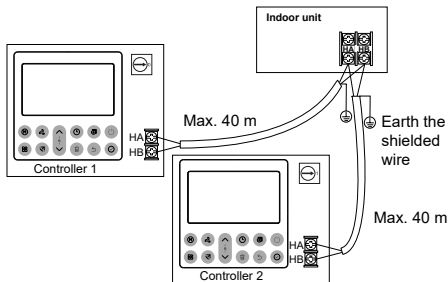

One controller to multiple units

For some units, one wired controller can support multiple units (a maximum of 16).

For configuration of multiple indoor units loom connection is polarity sensitive and HA must connect to HA on all indoor units, the same applies to HB. In group control there will be no error displayed on the wired controller.

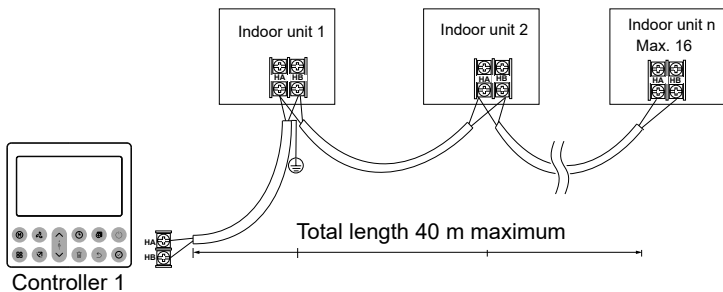

Reattach backing plate of the wired controller

To reconnect the fascia to the back plate, anchor the top lugs first as shown below then swing the fascia down and press lightly to engage the bottom tabs. Be careful not to pinch the loom during the process.

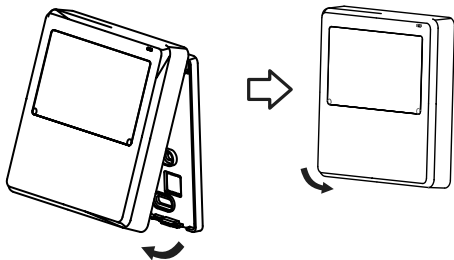

DO NOT allow water to enter the controller, use trap and putty to seal the connectors. Connecting wires must be securely fixed in place.

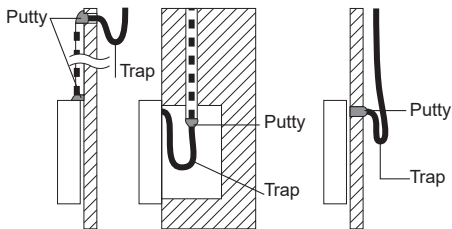

Controller operation



Functions

- Mode: Auto-Cool-Dry-Heat-Fan
- Fan speed: Auto/Low/Med/High
- Timer ON/OFF
- Temperature setting
- Weekly timer
- Follow me
- Turbo
- Child lock
- Clock

LCD display

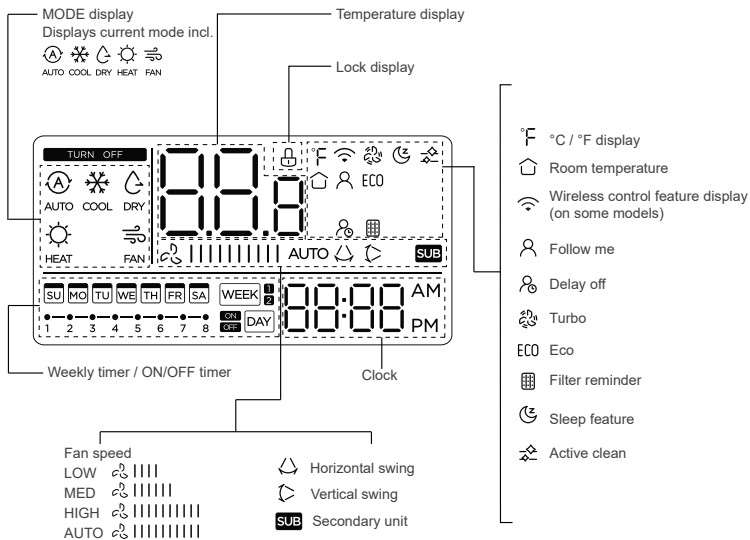

Controller buttons

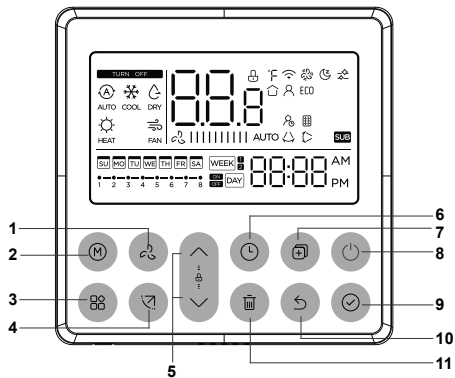

- | | |
|------------------------|----------------------|
| 1. Fan speed | 7. Copy |
| 2. Mode | 8. Power |
| 3. Function | 9. Confirm |
| 4. Swing (some models) | 10. Back |
| 5. Adjust | 11. Day off* / delay |
| 6. Timer | |

* This means single day schedule deactivation.

Setting the current day and time

1. Press the timer button for two seconds or more. The timer display will flash.
2. Press the down or up button to set the day. The selected day will flash.



3. Press the timer button then press the down or up button to set the current time. Press repeatedly to adjust the time in one minute increments.

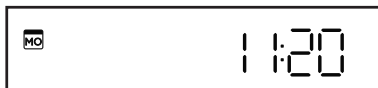

4. Complete the setting by pressing the confirm button.
5. 12 or 24 hour clock. Press the timer button and the day off / delay button for two seconds. This will alternate the clock display between 12 and 24 hours.

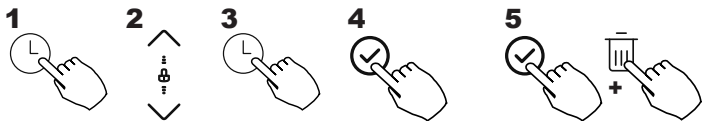

Operation

Turn on and off

Press the power button.



Selecting operation mode

Press the Mode button to cycle through the different modes of operation.

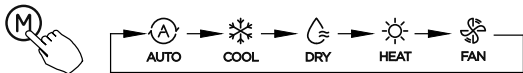

Adjusting room temperature setting

Press the up or down button to set the room temperature. Indoor setting temperature range 16-30 °C.

Pressing the confirm and down button for three seconds will alternate the temperature display between the °C and °F scale.

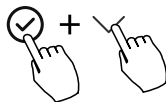

Adjusting fan speed setting

Press the fan speed button to set the fan speed. This button does not work when in Auto or Dry mode.

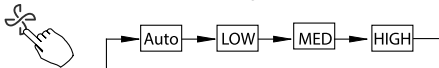

Keypad tone setting

Press the swing and function buttons together for three seconds to turn on or turn off the keypad tone.

Child lock function

Press the up and down buttons at the same time for three seconds to activate the child lock function and lock all the buttons on the controller. Press the same two buttons again to deactivate.

When the child lock function is activated the lock symbol appears.



Turbo

This mode allows you to cool indoor air quickly in summer or warm it quickly in winter. In Turbo mode the fan is set to operate at maximum output.

Turbo will only function when in cooling or heating mode. Press the function button until the turbo fan symbol appears, press again to deactivate.



Standard fan symbol



Turbo fan symbol

Follow me

Press the function button until the Follow me icon appears. Press confirm to activate.



When Follow me is activated the room temperature is detected at the sensor in the wired controller. When Follow me is not active the room temperature is detected at the air inlet of the indoor unit.

Sleep mode

Press the function button until the Sleep icon appears. Press confirm to activate Sleep mode. The ambient temperature will decrease 1° every hour for the first two hours, then it will hold a steady temperature for five hours, then it will switch off.



The feature is to provide increased comfort when sleeping as well as saving energy overnight.

Eco mode

Press the function button until the Eco icon appears. Press confirm to activate Eco mode, an 8-hour energy-saving mode reducing up to 60% of energy use.



Swing function (only for units with swing features)

Up-down swing

Press the Swing button for two seconds to start the left-right swing function. When activated the icon will appear.



Up-down airflow direction and swing

Press the Swing button to start the up-down swing function. When activated the icon will appear.



Active clean

Press the function button until the Active clean icon appears. Press confirm to start Active clean. The unit will enter in an automated process where the indoor unit coil will be cleaned and sterilised. This function can take up to 90 minutes to complete.



Active clean should be done at least twice a year, at the end of summer, and at the end of winter. This does not replace the requirement for yearly servicing of your unit. Contact your installer or Rinnai to schedule annual servicing.

Timer functions



WEEKLY timer

Use this timer function to set operating times for each day of the week.



On timer

Use this timer to start operation. The timer operates and operation starts after the time has passed.



Off timer

Use this timer to stop operation. The timer operates and operation stops after the time has passed.



On and Off timer

Use this timer to start and stop operation. The timer operates and operation starts and stops after the time has passed.

To set the ON or OFF timer

Press the timer button to select the ON day or OFF day. Press the confirm button, the timer display will blink.



Press the up or down buttons to set the time. After this is done the timer will automatically start or stop. Press the confirm button to lock in the settings.



To set the ON and OFF timer

Press the timer button to select the ON and OFF day. Press the confirm button, the clock display will blink. Press the up or down buttons to set the time for the ON timer, then press the confirm button to lock in this setting. Press the up or down buttons to set the time for the OFF timer, then press the confirm button to lock in this setting.

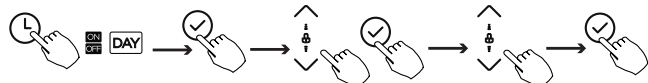

Please note: If you have a second wired controller, this controller cannot set the timer.

Weekly timer 1

Up to four timer settings can be saved for each day of the week. Press the timer button to select the week 1. Press the confirm button. Press the up or down buttons to select the day of the week, then press confirm.

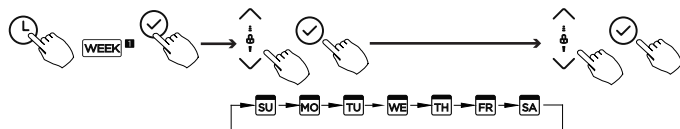

Press the up or down button to select the ON timer, press confirm to lock in the setting.

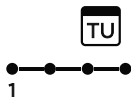

Press the up or down button to select the OFF timer, press confirm to lock in the setting.

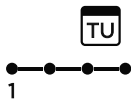

Weekly timer operation

To activate weekly timer operation, press the timer button while 'Week 1' is displayed on the LCD.

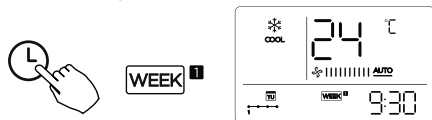

To deactivate weekly timer operation, press the timer button when 'Week 1' has disappeared from the LCD.

Turning off the system during the weekly timer

Press the power button once (quickly), the system will turn off temporarily but will come back on when the next timer is scheduled.

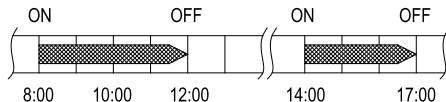

Example: By pressing the power button once (quickly) at 10am the system will stop, but will turn back on again at 2pm

By pressing the power button for two seconds the system will turn off completely.

To set a day off

1. During the weekly timer setting, press the confirm button.
2. Press the up or down button to select the day in the week.
3. Press the 'Day off' button to set the day off, in this example Wed.
4. The day off can be set for other days by repeating steps 2 and 3.
5. Press the back button to return to the weekly timer.

To cancel follow the same procedure as those for setting up. The day off setting is canceled automatically after the set day has passed.

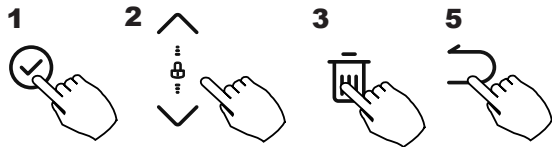

The **WE** mark is hidden

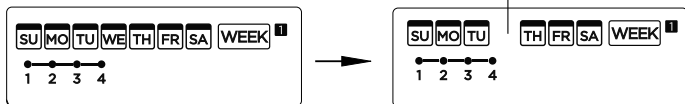

Delay function



During the weekly timer, press the function button. Select delay function and press the confirm button. The display will show “0h” “1h” “2h”, wait three seconds to confirm. When the delay function is activated, the delay off symbol will appear.

The delay function can only be enabled in Weekly Timer 1 and Weekly Timer 2.

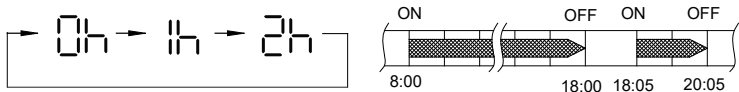

Example: By selecting “2h” at 18:05, the system will be delayed in turning off until 20:05.

Copying setting from one day into another

The entire schedule of one day of the week can be copied.

1. During the weekly timer, press the confirm button.
2. Press the up or down button to select which day to copy settings.
3. Press the copy button, the letters CY will appear on the LCD.
4. Press the up or down button to select the day to copy to.
5. Press the copy button to confirm.

Other days can be copied by repeating steps 4 and 5. Press the confirm button to save the settings and the back button to return to the weekly timer.

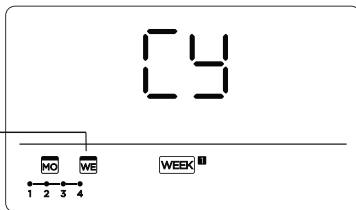

The **WE** mark flashes quickly

For example, copying the Monday setting to Wednesday.

Weekly timer 2

Press the timer button to select week 2, then press confirm. Various modes such as day of the week, on timers, time setting, operation mode setting, and room temperature are set here.

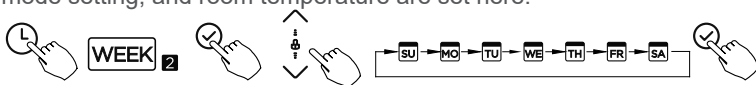

With week 2 up to eight scheduled events can be set on one day.

Time setting

Press the up or down button to select the time, then press the confirm button.

Operation mode setting

Press the up or down button to select operation mode, then press confirm.

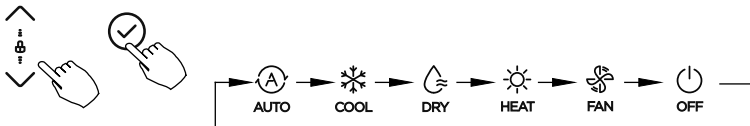

Room temperature setting

Press the up or down button to set the room temperature, then press confirm. This setting is not available when in FAN or OFF modes.

Fan speed setting

Press the up or down button to set the fan speed, then press confirm. This setting is not available when in AUTO, DRY or OFF modes

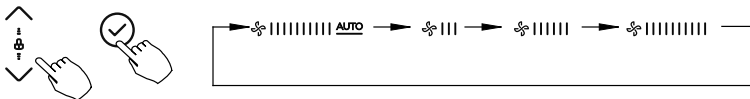

Different scheduled events can be set by repeating the steps on the previous pages. All the other operations, weekly timer operation, setting the day off, and copying settings are the same as those noted for WEEKLY TIMER 1.

Delete the time scale in one day

When in a weekly timer setting press confirm. Press the up or down button to select the day of the week and confirm.

Press the up or down button to select the setting time to be deleted. The setting time, mode and fan speed will appear on the LCD, and can be deleted by pressing the DELETE button.

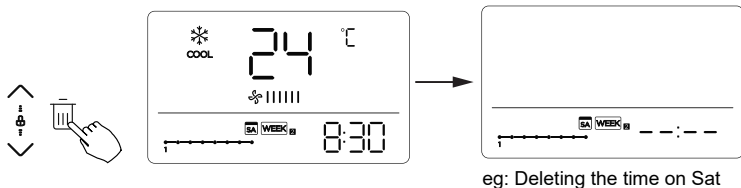

Fault codes

There are a number fault / error codes that could show on the controller. For a full list of what these are refer to the installation guide, available online at www.rinnai.co.nz. There is one error code that relates to a communication error between the wired controller and that of the indoor unit, this is **EH63**, this will require a service call.

Wi-Fi control

The system comes with Wi-Fi capability as standard, which features Wi-Fi control via an App.

Simple to activate and easy to use, the 'NetHome Plus' App can be downloaded via Google Play or the App store on a compatible mobile device.

Your home's Internet router relays requests from the App to control your air conditioner, just like your normal remote controller.

Set your favourite temperature before you come home. Available to download via:

- Google Play
- App Store



Please note



NetHome Plus is a third party App not run by Rinnai.

For this App to run the home's Internet router must be running on 2.4 GHz (not 5 GHz)—check the Wi-Fi settings on your device.

Wi-Fi registration and connection

As technology and App updates are frequent it has not been placed in this guide. If you are registering and connecting using the Wi-Fi App, please refer to the online user guide available on the Rinnai NZ website. Just enter 'NetHome Plus app' in the search field.

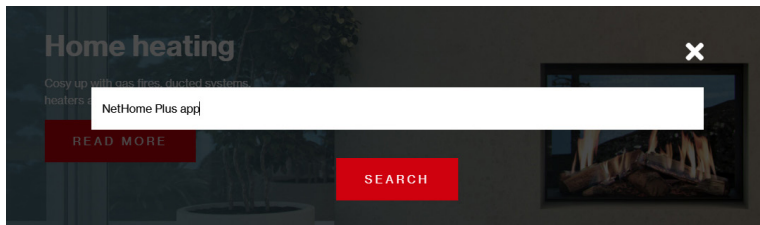

The steps to register and connect are:

1. Download and install the NetHome Plus App on a compatible mobile device
2. Complete an App registration by creating an account, this must be done in the home
3. Pair your mobile device to the unit via the home router

Please note:

When connecting the device you must finish all the steps in **eight minutes** after powering on the unit, otherwise you'll need to switch the unit off and go through the process again.

Rinnai.co.nz

Tel: 0800 746 624

<http://www.youtube.com/rinnainz>

<http://facebook.com.rinnainz>

R32 standard controller op & install guide
15129-B | 02-23