

This diagram is provided to assist you to identify parts if replacement is necessary. Contact your place of purchase or the manufacturer to enquire about parts, availability and/or service.

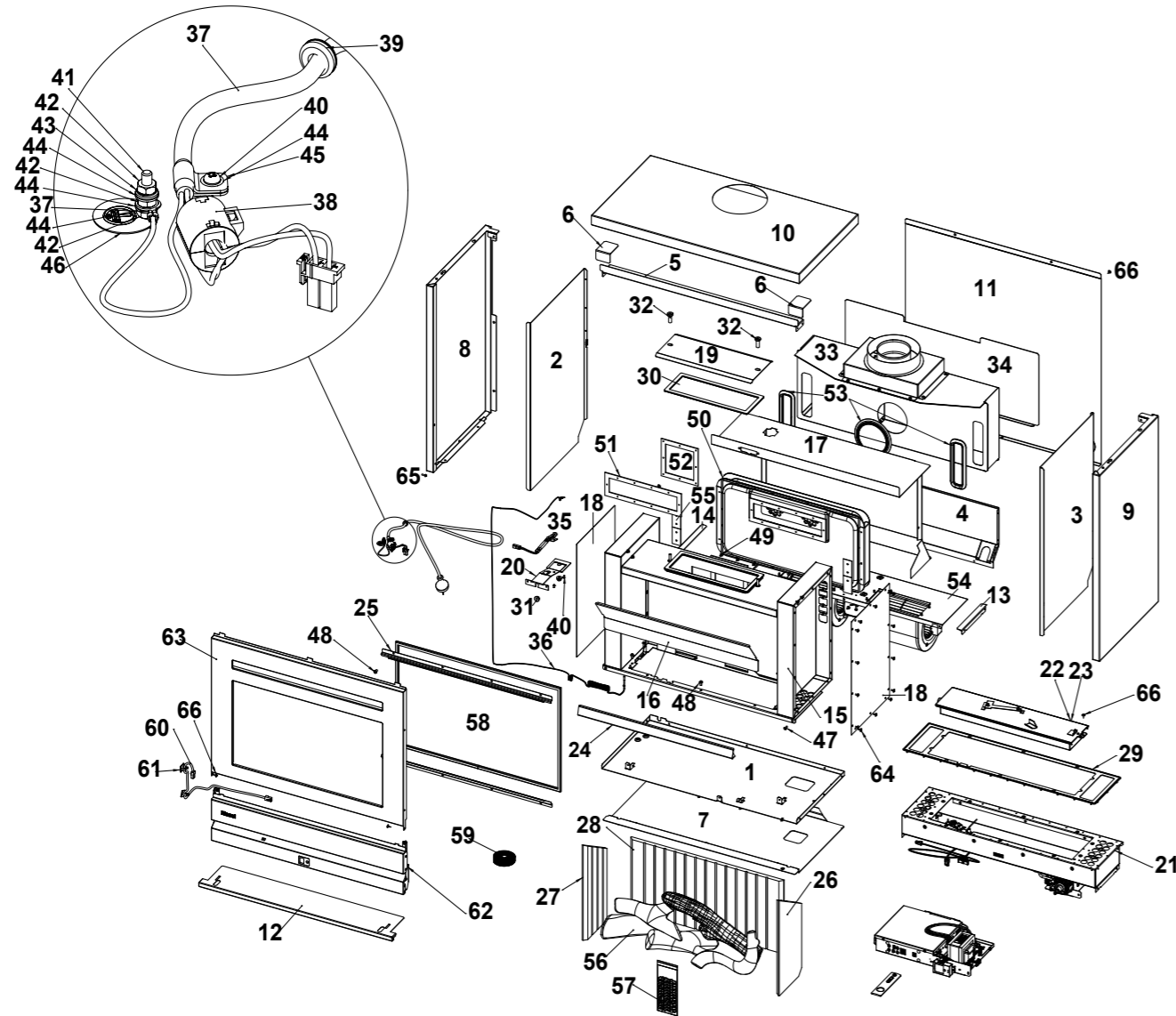

Ref.	Description	Part No.
1	Panel base	13121
2	Panel side LH	13959
3	Panel side RH	13958
4	Panel back	13785
5	Panel top trim	13960
6	Panel top mounting bracket	13975-1
7	Panel mount plate assembly	13987
8	Panel side LH outer black	13973GL
9	Panel side RH outer black	13972GL
10	Panel top outer black	13970GL
11	Panel back outer black	13971GL
12	Panel infill black	13986GL
13	Fan mount bracket RH	11860
14	Fan mount bracket LH	11859
15	Comb. chamber spare c/w gaskets	16060
16	Heat shield	13761F
17	Panel combustion chamber air guide	13781
18	Panel airbox cover (x2)	13789
19	Panel pressure relief flap	13779F
20	Bracket TH1 TF	13774
21	Gas control	p.2
22	Burner assembly black LPG	13795F
23	Burner assembly black NG	13797F
24	Pilot shield black	13743F
25	Glass bracket top/bottom (x2)	13961
26	Ceramic panel grooved RH	12368
27	Ceramic panel grooved LH	12366
28	Ceramic panel grooved back	12367
29	Silicon gasket seal	13782
30	Gasket pressure relief	13330
31	Grommet silicone 2Ø1.8 hole black (x2)	10294
32	Pin brass pressure relief (x2)	13780
33	Assembly flue connection coaxial	13775
34	Panel flue support	13950
35	Thermal fuse	13011
36	Harness RT OH1	13483

Ref.	Description	Part No.
37	Power cord	13042
38	Ferrite clamp	13004
39	Rubber grommet power cord	7132
40	Screw 8x¼ PPHSZ type B Phil (3)	9144
41	Screw M4 x 20 Pan Phil zinc	9073
42	Nut M4	9186
43	Spring washer M4	9233
44	Flat washer M4	9552
45	Power cord clamp	9552
46	Earth tag	11269
47	Screw M4 x 12 Pan Phil black (2)	9071
48	Screw M5 x 10 Zp (20)	9101
49	Screw 2 truss 4 x 8 tap chrome (22)	9154
50	HEX assembly c/w gaskets & screws	16051
51	Gasket HEX rectangle	10925
52	Gasket HEX square	10926
53	Air/flue seal kit	16050
54	Fan	16056
55	Inlet shutter plate	16059
56	Log set*	16057
57	Granules flame fire*	2544
58	Glass replacement c/w rope seal	11966
59	Rope seal 2 m	R7010
60	Cable CAT5 x 500 mm	10631
61	Cable clip (x2)	10309
62	Frame lower c/w ON/OFF	16055
63	Freestanding frame assembly spare	16054
64	Screw 8 x 10 THPSZ phil AB zinc	9151
65	Screw black 12 mm	9162
66	Screw 8 x 10 THPSB black	9020B

* Correct positioning of the log set and granules are critical to performance. Always follow the instructions detailed on the burn media sheet and install guide.

This diagram is provided to assist you to identify parts if replacement is necessary. Contact your place of purchase or the manufacturer to enquire about parts, availability and/or service.

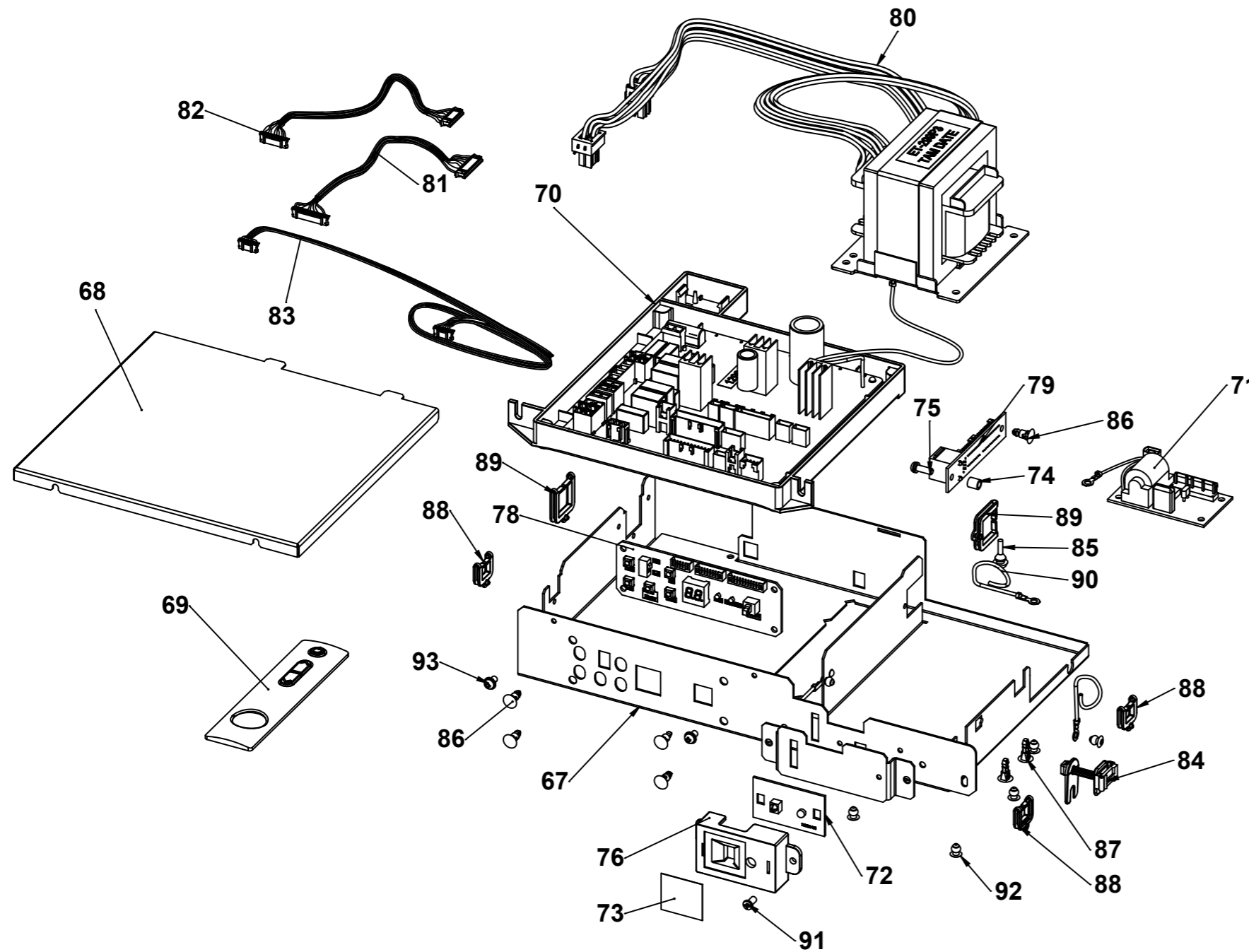

Ref.	Description	Part No.
67	Electrical box universal control	12811
68	PCB box lid	12929
69	Remote control IR universal	13040
70	PCB uni control (1 burner, nat. draft)	12966
71	Igniter	13006
72	PCB IR receiver	10393
73	Filter A for IR receiver	10266
74	Spacer M4 x 7 mm	13066
75	Screw M4 x 12 c/w washer	9070
76	PCB receiver case	10394
77	Receiver mounting bracket	13124
78	PCB display	10253
79	PCB interface board	12494
80	Transformer	10258
81	Harness 12-way control	12492
82	Harness 9-way control	12496
83	Harness 6-way receiver	12656
84	Thermistor holder	7540
85	Self-fix bumper (2)	11304
86	PCB spacer (5)	10428
87	PCB spacer black (4)	9004
88	Plastic edge protector EHS11U (x3)	1880
89	Plastic edge protector EHS18U (x2)	10471
90	Wire tie 80 mm (3)	4417
91	Screw M4 x 8 pan phil ZP	9063
92	Rivet pop plain 73AS52 (x7)	9315
93	Screw earthing c/w serrated washer (x2)	9143

This diagram is provided to assist you to identify parts if replacement is necessary. Contact your place of purchase or the manufacturer to enquire about parts, availability and/or service.

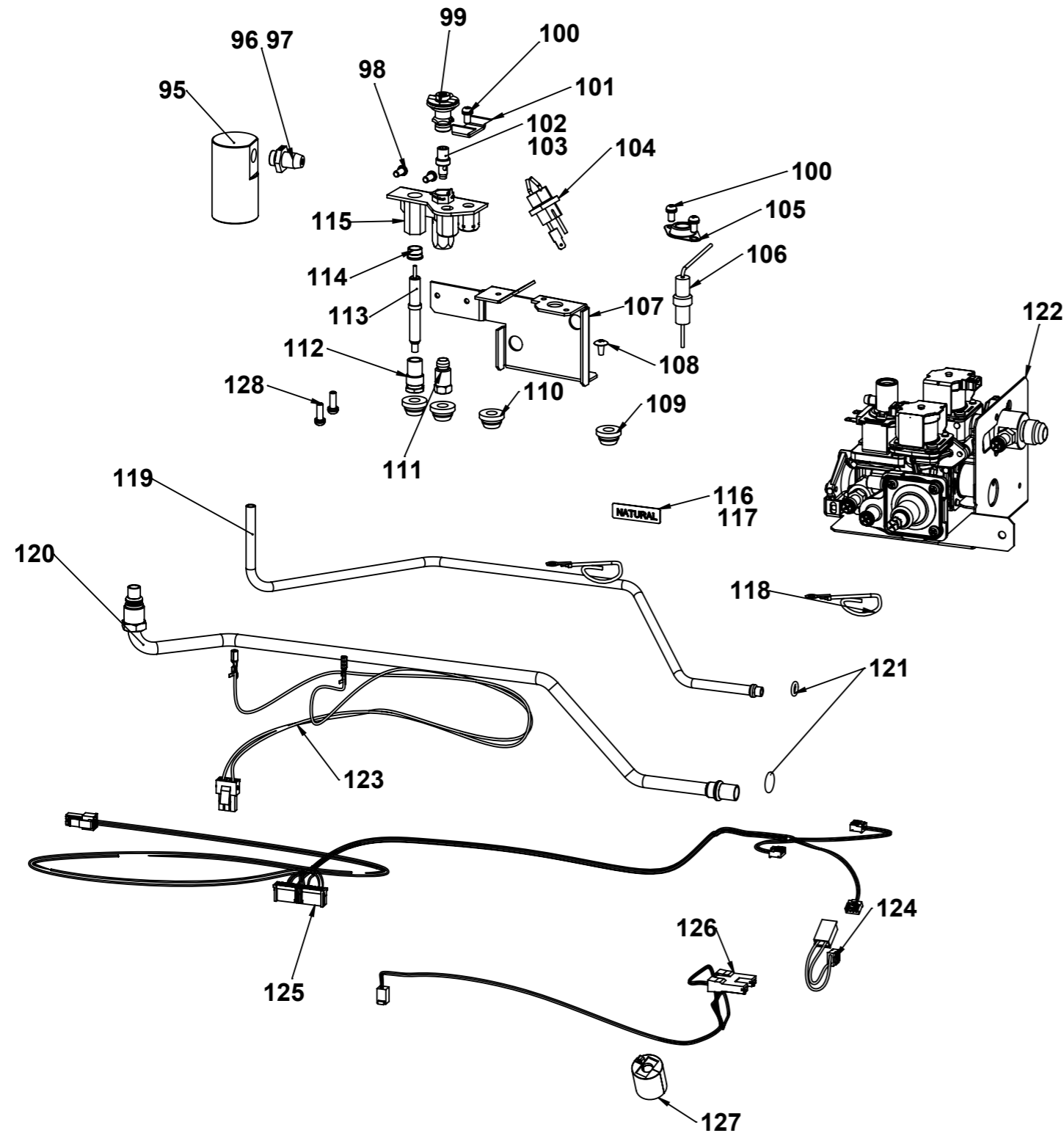

Ref.	Description	Part No.
95	Injector block	11530
96	Injector 2.8 NG	11892
97	Injector 1.55 LPG	11868
98	Screw M4 x 8 pan phil ZP (x2)	9063
99	Pilot convertible hood 3-flame	10272
100	Screw M4 x 8 PHPMZ c/w washer (x3)	9064
101	Electrode clamp universal control	13043
102	Pilot injector 62 NG	7795
103	Pilot injector 0.35 LPG	7873
104	Double spark electrode	10265
105	Flame rod bracket	3068
106	Flame rod	12620
107	Pilot bracket	13126
108	Screw truss 4 x 8 tap chrome (x2)	9154
109	Grommet silicone Ø4 hole red (x2)	10293
110	Grommet silicone 2Ø1.8 hole black (x2)	10294
111	Olive 6 mm	7519
112	Electrode nut	7900
113	Electrode	7875
114	Pilot electrode spacer	7902
115	Pilot body convertible	7870
116	Label gas type NG small	6696
117	Label gas type LPG small	7348
118	Wire tie 80 mm (x2)	4417
119	Pilot tube	13129
120	Gas supply tube assembly	13128
121	O-ring kit (1 x 10 mm, 1 x 6 mm)	16052
122	Gas control	13047
123	Harness flame rod	13008
124	Harness mV relay	13013
125	Harness TF MV	13014
126	Harness POV	13012
127	Ferrite clamp	13004
128	Screw M4 x 12 mach c/w washer (2)	9070

This diagram is provided to assist you to identify parts if replacement is necessary. Contact your place of purchase or the manufacturer to enquire about parts, availability and/or service.

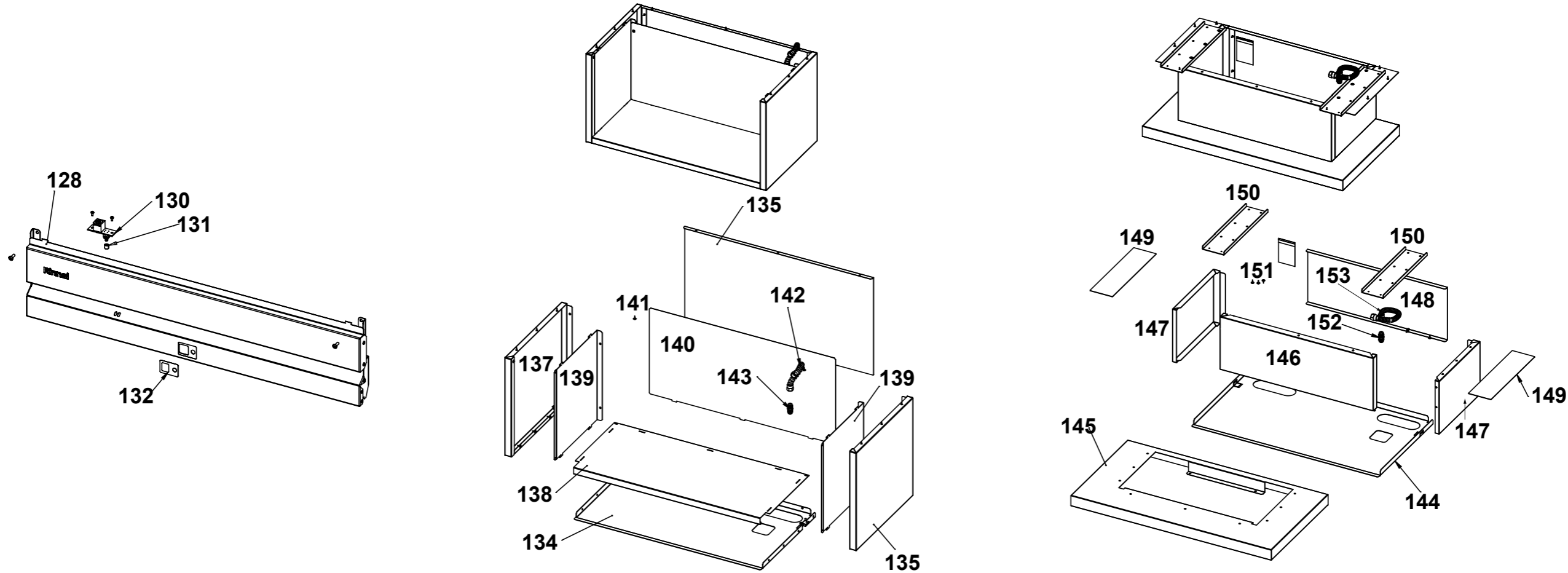

Ref.	Description	Part No.
Frame lower assembly (incl. all below parts)		16055
128	Lower rail assembly	13977GL
129	Screw pan head tapping (x2)	9150
130	PCB ON-OFF RJ45	13969
131	Button ON/OFF	13378
132	Filter B for IR receiver	10268
133	Screw M4 x 12 pan phil black (x2)	9071

Ref.	Description	Part No.
Freestander Cabinet Base (incl. all below parts)		R2362GL
134	Panel base	13988
135	Panel cabinet back black	13981GL
136	Panel cabinet side RH black	13979GL
137	Panel cabinet side LH black	13980GL
138	Panel cabinet base cover black	13982GL
139	Panel cabinet side cover black (x2)	13983GL
140	Panel cabinet back cover black	13985GL
141	Screw 8x10 Thpsb black (x30)	9020B
142	Flexi gas tube connector	7835
143	Brass flare connector	11300

Ref.	Description	Part No.
Freestander Plinth Base (incl. all below parts)		R2363GL
144	Panel base	13988
145	Panel plinth base black	13731GL
146	Panel plinth front black	13732GL
147	Panel plinth side black (x2)	13733GL
148	Panel plinth back black	13734GL
149	Panel plinth underside cover black (x2)	13729GL
150	Stiffening rail (x2)	13735
151	Screw 8 x 10 THPSB black (x36)	9020B
152	Brass flare connector	11300
153	Flexi gas tube connector	7835