

## **GENERAL INSTALLATION INFORMATION REU-V2626W / REU-V2632W SERIES**

You must install this appliance in accordance with these instructions and all regulatory requirements which exist in your area. Applicable publications may include:

- AG601/AS5601 – Gas Installations
- AS/NZ3500 – National Plumbing and Drainage
- AS/NZ300 – Wiring Rules
- Building Codes of Australia

THIS APPLIANCE IS DESIGNED FOR OUTDOOR INSTALLATION

IT MUST BE MOUNTED ON A VERTICAL WALL OR STRUCTURE WITH THE WATER AND GAS CONNECTIONS ON THE UNDERSIDE POINTING TOWARDS THE GROUND.

THIS APPLIANCE MUST NOT BE USED AS A DOMESTIC SPA OR SWIMMING POOL HEATER.

### APPLIANCE LOCATION

The appliance should be placed as close as practicable to the most frequently used hot water outlet point or points to minimize the delay time for hot water delivery. For installations where the distance between the unit and hot water outlet points is considerable, the appliance can also be fitted in a 'flow and return system' which minimizes the waiting time for hot water delivery. Alternatively, multiple appliances can be placed strategically to service outlet points with minimal delay time.

Location of the appliance flue terminal must be in accordance with the clearances shown in Figure 5.3 of AG601/AS5601-2002 which is reproduced right side. Ensure that the flue terminal and hot water outlet connection cannot be touched by children. The appliance must be clear of obstructions and shrubbery.

The appliance must be in an accessible location. Sufficient clearances shall allow access to, and removal of, all serviceable components. The appliance should not be mounted higher than 3.5 metres from the ground or floor level unless the customer can arrange permanent and safe access or can arrange means of access, for example, by means of scissor or boom lifts.

AC240V, 10A weatherproof external earthed power point shall be provided adjacent to the appliance. It must be clear of the gas and water connections to the appliance, flue exhaust and water pressure relief valve. The power cord of the appliance is 1500mm long.

Note that AG601/AS5601-2002 was current at the time of printing but may have been superseded. It is the installer's responsibility that the current clearance requirements are met.

### PIPE SIZING

This appliance can use up to 199 MJ/h of gas. If the gas pipe sizing is insufficient the customer will not get the full performance benefit. Gas pipe sizing must consider the gas input to this appliance as well as all the other gas appliances in the premises. The gas meter and regulator must be specified for this gas rate. An approved sizing chart such as the one in AG601 / AS5601 should be used.

Water pipe sizing and layout should be performed in accordance with AS/NZ3500. All hot water pipe-work should be insulated to optimize maximum performance and energy efficiency.

### WATER SUPPLY

Where the water supply pressure exceeds 1200 kPa, an approved pressure limiting valve is required at the inlet of the appliance. To achieve the rated flow a minimum water supply pressure of 140 kPa is required at the appliance inlet. The unit will operate at lower supply pressures but the rated flow will not be achieved. Contact Rinnai for 'gravity fed' or 'low pressure' hot water installations.

WATER SUPPLY continued

The water quality should be in accordance with the guidelines contained in the 'How to use your Water Heater' booklet. If you are unsure of your water quality, contact your local water authority. If sludge or foreign matter is present in the water supply, a suitable filter should be incorporated in the cold water supply pipe.

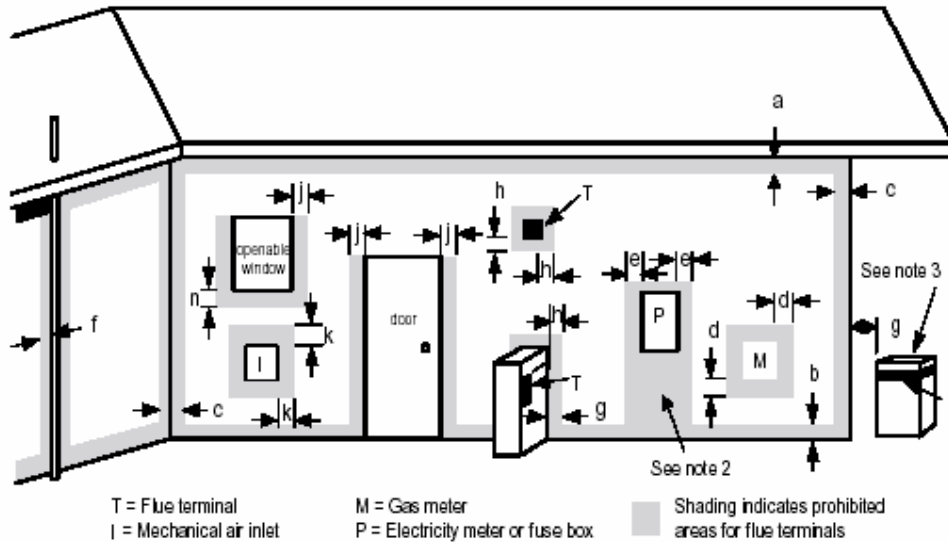

Ref	Item	Min clearances (mm)
		Fan assisted
a	Below eaves, balconies and other projections	
	<ul style="list-style-type: none"> <li>• Appliances up to 50 MJ/h input</li> <li>• Appliances over 50 MJ/h input</li> </ul>	200 300
b	From the ground, above a balcony or other surface †	300
c	From a return wall or exterior corner †	300
d	From a gas meter (M) (see 4.7.11 for vent terminal location of regulator)	1000
e	From an electricity meter or fuse box (P)	500
f	From a drain pipe or soil pipe	75
g	Horizontally from any building structure = or obstruction facing a terminal	500
h	From any other flue terminal, cowl, or combustion air intake †*	300
j	Horizontally from an openable window, door, non-mechanical air inlet, or any other opening into a building with the exception of sub-floor ventilation:	
	• Appliances up to 150 MJ/h input	300
	• Appliances over 150 MJ/h input up to 200 MJ/h input	300
	• Appliances over 200 MJ/h input	500
	• All fan assisted flue appliances, in the direction of discharge	1500
k	From a mechanical air inlet, including a spa blower	1000
n	Vertically below an openable window, non-mechanical air inlet, or any other opening into a building with the exception of sub-floor ventilation:	
	• Space heaters up to 50 MJ/hr input	150
	• Other appliances up to 50 MJ/hr input	500
	• Appliances over 50 MJ/hr and up to 150 MJ/hr input	1000
	• Appliances over 150 MJ/hr input	1500

† - unless appliance is approved for closer installation

**Fig 5.3**

## CLEARANCES continued

### NOTES:

1. All distances are measured to the nearest point of the terminal
2. Prohibited area below electricity meter or fuse box extends to ground level
3. See clause 5.13.6.6 for restrictions on flue terminal under a covered area
4. See Appendix J, Figures J2 (a) and J3 (a), for clearances required from a flue terminal to an LPG Gas cylinder. A flue terminal is considered to be a source of ignition.
5. For appliances not addressed above, approval shall be obtained from the Authority

\* Contact Rinnai for exemptions for the above clearances which may have been granted since printing of this document.

## HOT WATER DELIVERY TEMPERATURE

Local regulations and / or the requirements of AS/NZ3500.4 must be considered regarding the temperature limitations of hot water supplied to areas used primarily for personal hygiene. The temperature of water to these areas may be limited to 50°C or less. To ensure these regulations and / or requirements are met the system MUST be installed in accordance with the 'Water Heater and Controller Installation Configurations' section of this document.

## MOUNTING THE APPLIANCE

The appliance weighs 21kg and the wall or structure on which it is to be mounted must be capable of supporting the weight of the appliance and associated pipe-work.

Ensure that suitable fixing screws or bolts are used to secure the Infinity to the wall. Bracket and fixing hole locations are show overleaf.

The top bracket has a keyhole slot so that the appliance can be positioned by hanging it on one screw, then the other screws can be secured.

After determining the most suitable position, fix the Infinity to the wall.

## SERVICE CONNECTION POINTS

Positions of the cold water inlet, hot water outlet and gas connections are shown overleaf. All connections are R ¾ (20mm). This is NOT an indication of the pipe sizes required.

An approved isolation valve and disconnection union MUST be fitted to the cold water inlet. A non return valve is not required unless dictated by local regulations.

An approved isolation valve and disconnection unit MUST be fitted to the gas inlet. Isolation Valves must not be fitted directly to the appliance.

It may be necessary to fit a temperature limiting device for delivery to areas used primarily for personal hygiene. Refer to the 'Water Heater and Controller Installation Configurations' Section of this document.

Purge hot and cold water supply lines to remove air and swarf before final connection of the appliance. Swarf in either the gas or water supplies may cause damage.

## ACCESSORIES

Recess Box: The appliance can be 'recessed' into the wall for flush fitting reducing even further the space required. A custom made Rinnai Infinity Recess Box must be used for this purpose.

Pipe Cover: The pipe-work underneath the appliance can be covered using a custom made Rinnai pipe cover.

ACCESSORIES continued

Security Cage: A Security Cage can be fitted around the appliance.

Contact Rinnai for further details.

REMOTE CONTROLLERS

Remote Controllers are an optional extra 'Standard' and 'Deluxe' controls can be fitted. Standard controls allow temperature selection only. Deluxe controls have temperature selection, bath-fill and voice prompting functions.

For detailed information regarding controller operation refer to the 'How to use your Water Heater' booklet supplied with the appliance. Other manufacturers' controllers are NOT compatible with this appliance.

**STANDARD CONTROLLER (MODEL MC-91-1A)**

Up to 4 Standard Controls can be fitted to the appliance. They are normally installed in the areas where the majority of hot water is used, for example, the kitchen, bathroom, ensuite and laundry.

**DELUXE CONTROLLERS (MODELS MC-70-2A AND BC-70-2A)**

Deluxe controllers have 'kitchen' (MC-70-2A) and 'bathroom' (BC-70-2A) versions. Kitchen controls are intended for the kitchen or other convenient area where the majority of hot water is used. Bathroom controllers are intended to be fitted in the bathroom or ensuite and allow the user to have a bath filled to the required level and temperature automatically.

Up to three deluxe controllers can be connected as follows:

Kitchen	Bathroom	Ensuite
MC-70-2A		
MC-70-2A	BC-70-2A	
MC-70-2A	BC-70-2A	BC-70-2A

If a fourth controller is required, a Standard controller can be included as follow:

Kitchen	Bathroom	Ensuite	Laundry
MC-70-2A			
MC-70-2A	BC-70-2A		
MC-70-2A	BC-70-2A	BC-70-2A	MC-91-1A

**POSITIONING OF CONTROLLERS**

Controllers must be installed in shaded and clean locations. They should be fitted out of reach of children (suggested height from floor at least 1500mm). Controllers are water resistant, however, durability is improved when positioned outside the shower recess or at least 400mm above the highest part of a sink, basin or bath.

**DO NOT INSTALL THE CONTROLLERS**

- Near a heat source, such as a cook top, stove or oven, heat, steam, smoke and hot oil may cause damage
- In direct sunlight
- Outdoors unless an enclosure is provided which protects the controller against sunlight and dust ingress
- Against a metal wall unless the wall is earthed in accordance with AS/NZ3000

## REMOTE CONTROL CABLES

Remote controls operate at extra low voltage (12 Volts DC) which is supplied from the appliance. Controllers are supplied with 15m of electrical cable. The cable wires for connection to the appliance are fitted with spade terminals. Extension cables are available from Rinnai. Alternatively, a two core sheathed (double insulated) flex with minimum cross-sectional area of 0.5mm<sup>2</sup> can be used. Maximum cable length is 50m. For connection refer to the "CONNECTING REMOTE CONTROL CABLES" section.

### FITTING THE 'STANDARD' REMOTE CONTROLLERS (MC-91-A)

1. Determine the most suitable position for the Remote Control
2. Drill 3 holes in the wall, as shown in fig.1, one for the cable two for the securing screws. Ensure holes are drilled. Fit wall plugs if required.
3. Run the cable through the hole in the wall-ensuring that the end fitted with the connector is near the connector (fig.3).
4. Remove the face plate from the Remote Control, using a screw driver (fig.2).
5. Connect the cable to the remote controller.
6. Fix the remote controller to the wall and fasten with phillips head screws supplied as shown in fig.4.
7. Remove the protective plastic film from the controller face as shown in fig.4
8. Replace the face plate.

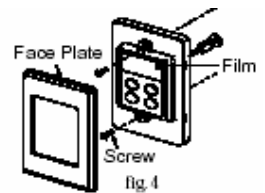
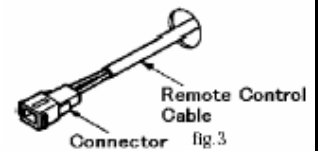
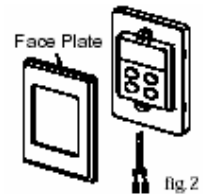
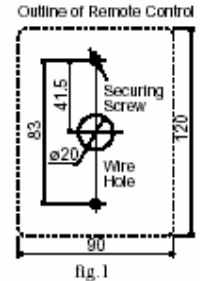

Note: For details on how to program the MC-91 remote control see Appendix 1. MC-91-1A Controller Programming.

### FITTING THE 'DELUXE' REMOTE CONTROLLERS (MC-70-2A)

1. Determine the most suitable position for the Remote Control.
2. Drill 3 holes in the wall, as shown in fig.1, one for the cable and two for the securing screws. Ensure holes are drilled. Fit wall plugs if required.
3. Fix the mounting bracket to the wall using the screws provided.
4. Run the cable through the hole in the wall.
5. Remove the face plate from the Remote Control, using a screw driver (fig.2).

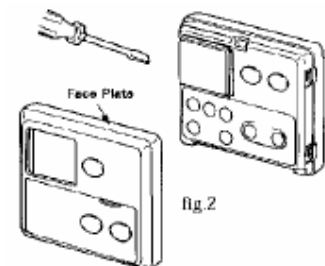
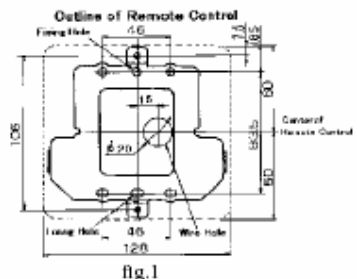

FITTING THE 'DELUXE' REMOTE CONTROLLERS (MC-70-2A) continued

6. Connect the cable to the kitchen remote control as shown in fig.3. Connect cables from the bathroom controllers (if fitted) to the kitchen remote control also (if required). Polarity is not important: either colour wire can be connected to either terminal.

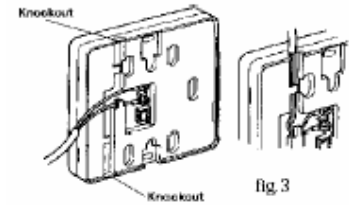

Note: If the cable cannot be run in the wall cavity, remove the plastic 'knockout' lugs as shown in fig.3

7. Fix the kitchen controller to the wall bracket and fasten with phillips head screws supplied (M4 x 12) as shown in fig.4.
8. Remove the protective plastic film from the controller face as shown in fig.5.
9. Replace the face plate.
10. Close the flip panel.

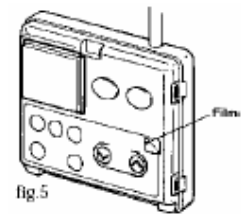
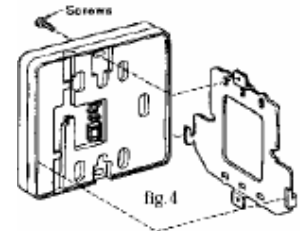

FITTING THE DELUXE REMOTE CONTROLLERS (BC-70-2A)

1. Determine the most suitable position for the Remote Control.
2. Drill 3 holes in the wall, as shown in fig.1, one for the cable and two for the securing screws. Drill holes to ensure controller position will be level when installed. Fit wall plugs if required.
3. Run the cable through the hole in the wall-ensuring that the end fitted with the connector is near the controller (fig.1).
4. Remove the face plate from the Remote Control, using a screw driver (fig.2).
5. Connect the cable to the bathroom remote controller.
6. Fix the bathroom controller to the wall and fasten with phillips head screws supplied as shown in fig.3.
7. Remove the protective plastic film from the controller face as shown in fig.4.
8. Replace the face plate.
9. Close the flip panel.

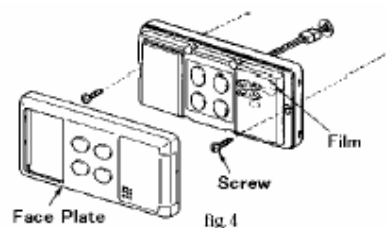
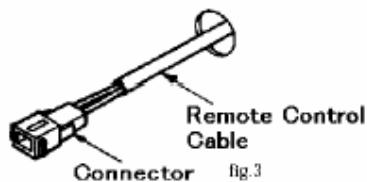
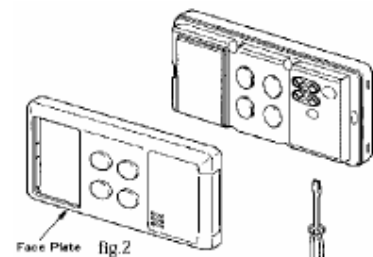
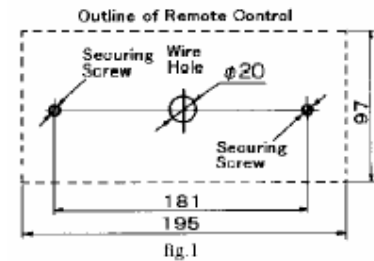

## WATER HEATER AND CONTROLLER INSTALLATION CONFIGURATIONS

- If the front cover of the appliance does NOT contain the following text install it in accordance with Diagram 1 below.

"THIS APPLIANCE DELIVERS WATER NOT EXCEEDING 50°C IN ACCORDANCE WITH AS 3498"

- If the front cover of the appliance does NOT contain the above text install it in accordance with Diagram 2 below.
- **IMPORTANT:** If the appliance is to deliver water primarily for the purposes of personal hygiene in an early childhood centre, primary or secondary school, nursing home or similar facility for young, aged, sick or disabled persons as defined in AS/NZ3500.4 a Temperature Limiting Device (TLD), such as a Tempering Valve, may be required even if the appliance is set to 50°C or less. For these types of applications contact Rinnai.

**Diagram 1 - 50°C Appliance**

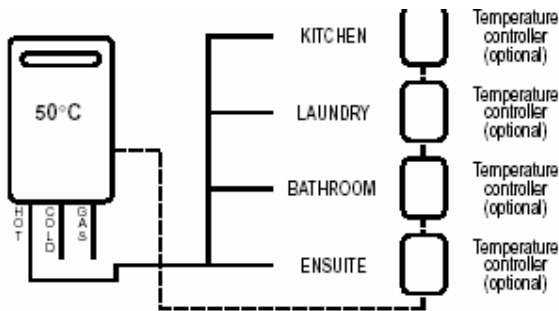

**Diagram 2 - Not a 50°C Appliance**

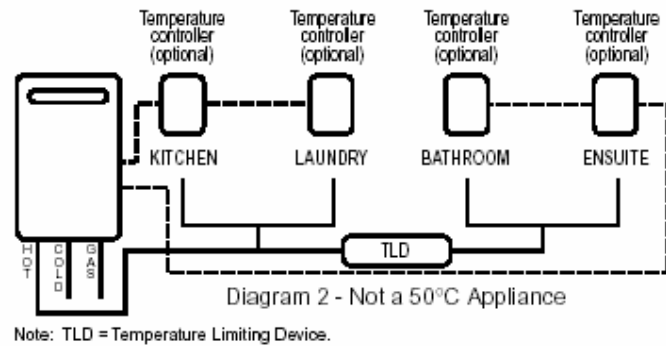

## CONNECTING THE REMOTE CONTROLLER CABLES

**⚠** Do not attempt to connect the remote control cable terminals to the appliance with the power on.

**RISK OF ELECTRICAL SHOCK!**

### *Connecting One or Two Controllers*

1. Isolate the power supply.
2. Remove the front cover from the Appliance (4 screws) fig.1
3. Thread the cable(s) through the cable access hole at the base of the appliance.
4. Connect the spade connectors to the terminals marked 'Remote Control' on the printed circuit board. (fig 2). Polarity is not important. Either wire colour can be connected to either terminal.
5. Replace cover of the Appliance. Ensure that the screw with the star washer is placed at the bottom right hand corner for earthing purposes.

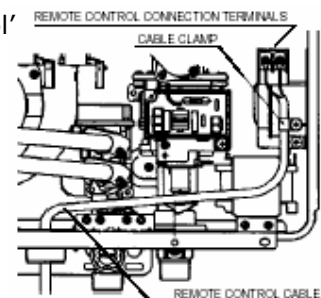
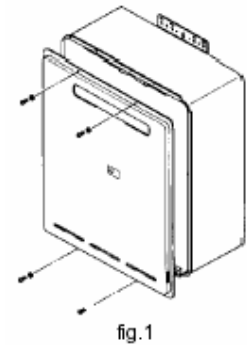

### *Connecting Three Controllers*

1. Isolate the power supply.
2. Remove the front cover from the Appliance (4 screws) fig.1
3. Cut the spade connectors from 2 of the controller cables to be connected to the appliance (4 spade connectors should be cut off) and discard. Connect the wires from these two cables and terminate into two new spade connectors as shown in fig.3. Spade connectors are available from your local electrical component retailer.
4. Thread the 3 cables through the cable access hole at the base of the appliance. Connect the 4 spade connectors to the terminals marked 'Remote Control' on the printed circuit board (fig.2). Polarity is not important. Either wire colour can be connected to either terminal.
5. Replace cover of the Appliance. Ensure that the screw with the star washer is placed at the bottom right hand corner for earthing purposes.

### *Connecting Four Controllers*

1. Isolate the power supply.
2. Remove the front cover from the Appliance (4 screws) fig.1.
3. Cut the spade connectors from all 4 controller cables to be connected to the appliance (8 spade connectors should be cut off) and discard. Connect the wires from two cables and terminate into two new spade connectors as shown in fig.3.

Repeat for the remaining two cables. Spade connectors are available from your local electrical component retailer.

4. Thread the 4 cables through the cable access hole at the base of the appliance. Connect the 4 spade connectors to the terminals marked 'Remote Control' on the printed circuit board (fig.2). Polarity is not important. Either wire colour can be connected to either terminal.
5. Replace cover of the Appliance. Ensure that the screw with the star washer is placed at the bottom right hand corner for earthing purposes.

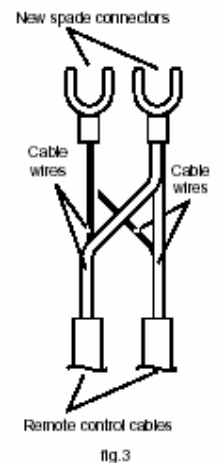

### TESTING AND COMMISSIONING

1. Before final connection of Infinity purge gas and cold water supply lines. Swarf in either the gas or water supplies may cause damage.
2. Turn on gas and cold water supplies.
3. Test for water leaks and gas escapes near the unit.
4. Isolate gas supply. Remove test point screw located on the gas inlet connection and attach pressure gauge.
5. Turn the power 'on' at the power point socket and turn on gas.



## TESTING AND COMMISSIONING continued

6. If remote controllers are fitted, turn the controller 'on', select the maximum delivery temperature and open ALL available hot water taps including the shower. If remote controllers are not fitted, simply open all available hot water taps. (CAUTION: Ensure building occupants do not have access to hot water outlets during this procedure).
7. Operate ALL other gas appliances at their maximum gas rate, in accordance with manufacturers instructions.
8. With all gas appliances in operation at maximum gas rate, the pressure gauge at the incoming test point, the Infinity should read 1.13 – 3.0 kPa on Natural Gas. On LPG the pressure should be 2.75 – 3.0 kPa. If the pressure is lower, the gas supply is inadequate and the Infinity unit will not operate to specification. Check gas meter, regulator and pipe-work for correct operation/sizing and rectify as required. Note that the gas regulator on the Infinity is electronically controlled and factory pre-set. Under normal circumstances it DOES NOT need adjustment during installation.
9. Close hot water taps including the shower.
10. Inspect and clean the strainer located on the cold water inlet connection. This procedure may need to be repeated to ensure the strainer remains clear, especially on new installations.
11. If Temperature Controllers are fitted, it is necessary to test their operation through the complete range of functions. (Refer to the 'How to use your Water Heater' booklet).
12. Confirm the hot water delivery temperature(s) using a thermometer. If controllers are fitted, ensure temperatures exceeding 50°C cannot be selected on controllers fitted in the bathroom or ensuite.
13. After testing is completed, explain to the householder the functions and operation of the water heater and temperature controllers (if fitted). Ensure the 'Customer Record' section of the 'How to use your Hot Water Heater' booklet is filled in and that the booklet is handed to the customer. Remind the customer to complete the Warranty Card and forward to Rinnai.

## GAS PRESSURE SETTING

The regulator on the Infinity is electronically controlled and factory pre-set. Under normal circumstances it does not require adjustment during installation. Perform this procedure only if the unit is not operating correctly and all other possible causes for incorrect operation have been eliminated.

1. Turn 'OFF' the gas supply.
2. Turn 'OFF' 240V power supply.
3. Remove the front cover from the appliance.
4. Check gas type switches (fig.1) are in the correct position (dipswitch 1 of SW2 'ON' = NG, 'OFF' = LPG).

Note: 'ON' towards front, 'OFF' towards rear

5. Attach pressure gauge to burner test point, located on the gas control (fig.2)
6. Turn 'ON' the gas supply.

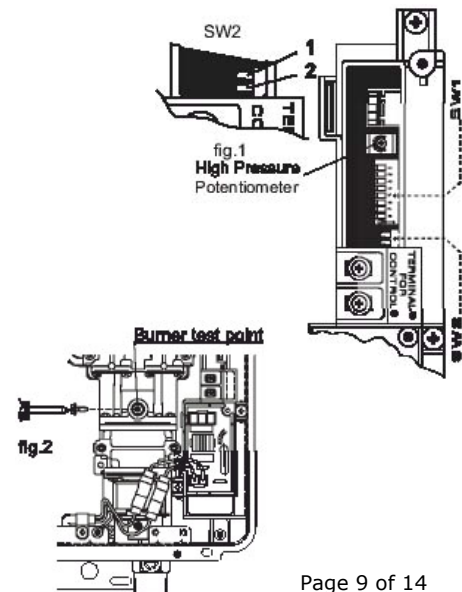

GAS PRESSURE SETTING continued

7. Turn 'ON' 240V power supply.
8. If remote controllers are fitted, turn the unit 'ON' at the kitchen controller, select the maximum delivery temperature of 55°C and open a hot water tap fully. (CAUTION: Ensure building occupants do not have access to hot water outlets during this procedure).
9. Set the Infinity to 'Forced Low' combustion by setting No. 7 dipswitch of the SW1 set of dip switches to 'ON' (fig.3).
10. Check the burner test point pressure.
11. Remove rubber access plug and adjust the regulator screw on the modulating valve (fig.4) as required to the pressure. Table 1. Replace rubber access plug.
12. Set the Infinity to 'Forced High' combustion by setting both No.7 and No.8 dipswitches of the bottom (SW1) set to 'ON' (fig.5). Ensure maximum water flow.
13. Check the burner test point pressure.
14. Adjust the high pressure Potentiometer (POT) on the Printed Circuit Board (PCB). As required to the pressure shown Table 2. (fig.1).
15. IMPORTANT: Set dip switches No's 7 and 8 on the bottom (SW1) set of switches to 'OFF' to return the appliance to 'Normal' combustion.
16. Close hot water tap.
17. Turn OFF the gas supply and 240V power supply.
18. Remove pressure gauge, and replace sealing screw.
19. Turn 'ON' the gas supply and 240V power supply.
20. Operate unit and check for gas leaks at the test point.
21. Replace the front cover of the appliance.

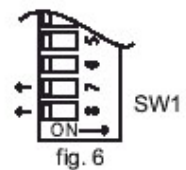
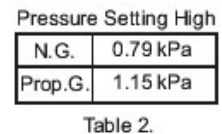
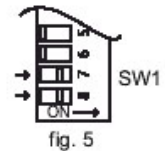
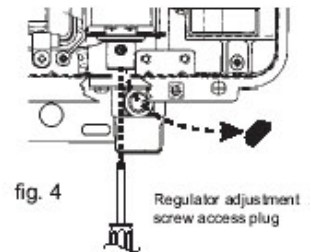
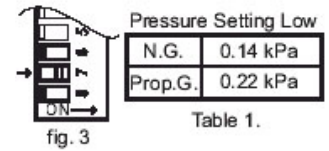

**WARNING**

DURING PRESSURE TESTING OF THE INSTALLATION  
ENSURE GAS COCK SITUATED BEFORE UNIT IS SHUT-OFF.

FAILURE TO DO SO MAY RESULT IN SERIOUS  
DAMAGE TO THE APPLIANCE AND POSSIBLE INJURY.

# WIRING DIAGRAM

## WIRING DIAGRAM OF REU-V2626W SERIES

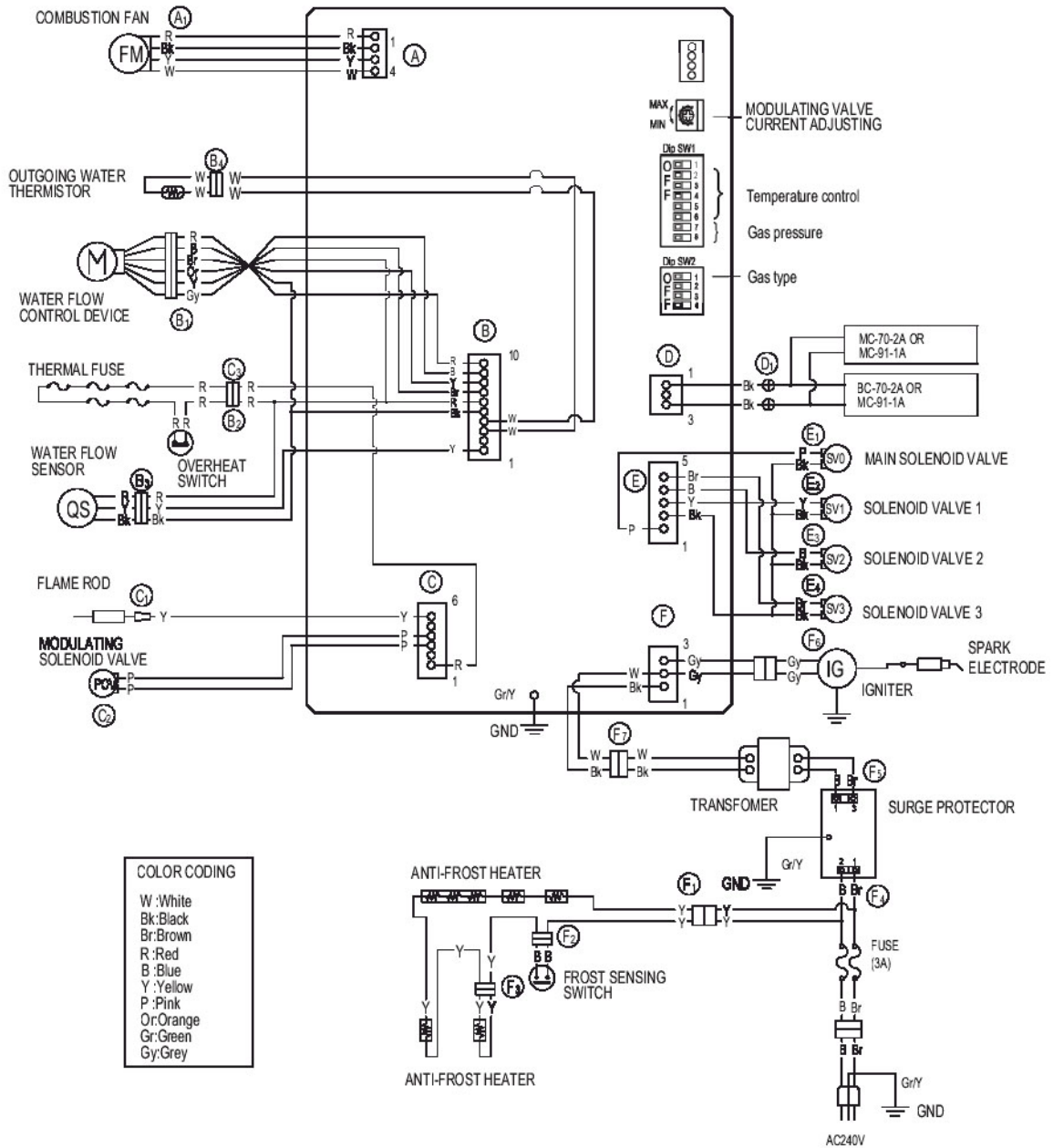

## DIAGNOSTIC POINTS

Flow Chart No.	Component	Measurement Point		Normal Value	A Note
		CN	Wire Colour		
1.	Surge Protector	F <sub>5</sub>	B-Br	AC207~264V	
2. 15.	Water Flow Control Device	B <sub>1</sub>	R-B	DC11~13V	Operate Electricity
			Gy-Or	DC11~13V	Control Electricity
			Gy-Y	Below DC1V (Limiter On) DC4~6V (Limiter Off)	Full Open Position
			Gy-Br	Below DC1V (Limiter On) DC4~6V (Limiter Off)	Full Close Position
3.	Remote Control	D <sub>1</sub>	Bk-Bk	DC11~13V	
4.	Water Flow Sensor	B <sub>3</sub>	R-Bk	DC11~13V	ON2.7 L/min (30Hz) OVER 1800 Pulse/min OFF2.0 L/min (20Hz) BELOW 1200 Pulse/min
			Y-Bk GND	DC4~7V (Pulse 17~460Hz)	
5.	Combustion Fan	A <sub>1</sub>	R-Bk	DC6~45V	
			Y-Bk	DC11~13V	
			W-Bk GND	DC5~10V (33~400Hz)	
6.	Flame Rod	C <sub>1</sub>	Y-Body Earth	AC6~150V	After ignition
			Y-Flame Rod	Over DC1μA	Flame condition
7.	Modulating Solenoid Valve	C <sub>2</sub>	P-P	DC2~16V 67-81Ω	
8.	Outgoing Water Thermistor	B <sub>4</sub>	W-W	15°C...11.4~14.0kΩ 30°C...6.4~7.8k Ω 45°C...3.6~4.5k Ω 60°C...2.2~2.7k Ω 105°C...0.6~0.8 Ω	
9.	Thermal Fuse	B <sub>2</sub> C <sub>3</sub>	R-R	Below 1Ω	
10.	Igniter	F <sub>6</sub>	Gy-Gy	AC90~110V	
11.	Main Solenoid Valve	E <sub>1</sub>	P-Bk	DC80~100V 1.7~2.1kΩ	
12.	Solenoid Valve 1	E <sub>2</sub>	Y-Bk	DC80~100V 1.7~2.1kΩ	
13.	Solenoid Valve 2	E <sub>3</sub>	B-Bk	DC80~100V 1.7~2.1kΩ	
14.	Solenoid Valve 3	E <sub>4</sub>	Br-Bk	DC80~100V 1.7~2.0kΩ	On Manifold

## TRANSFORMER VOLTAGES AND RESISTANCE

CN	Wire Colour	Normal Value
F <sub>5</sub>	B-Br	16~18Ω
F <sub>7</sub>	W-Bk	AC90~110V

# WATER HEATER DIMENSIONS

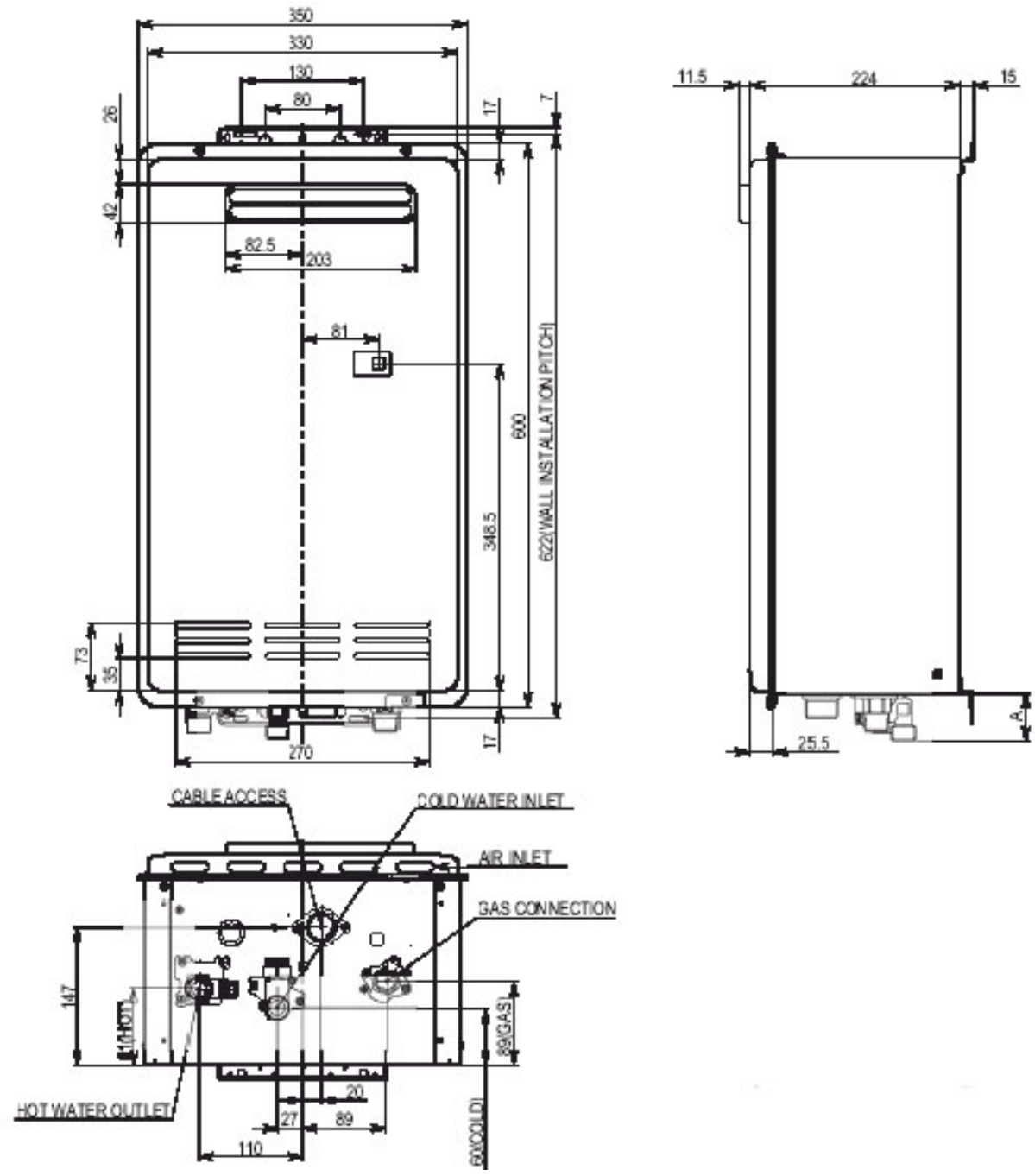

	A Dimensions
GAS	40
COLD	50
HOT	41

- Cold water inlet: 20mm
- Hot water outlet: 20mm
- Gas inlet: 20mm

## REMOTE CONTROLLER DIMENSIONS

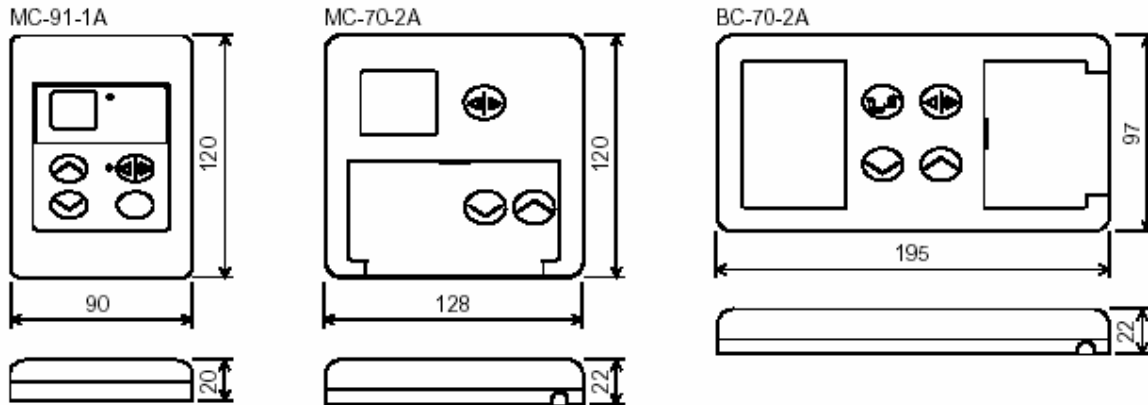

## APPENDIX 1. MC-91-1A CONTROLLER PROGRAMMING

Question 1: Are 4 controllers connected?

IF YES: You will need to activate the fourth controller.

### Step 1

For the controller in the KITCHEN only, press and hold the 'Transfer' and 'On/Off' buttons simultaneously (see fig.1) until a 'beep' is heard (approximately 5 seconds).

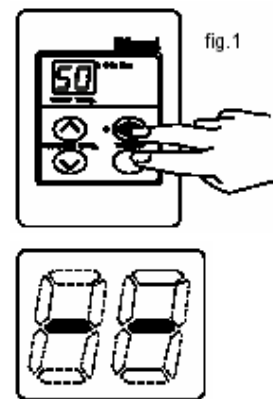

### Step 2

Check that the display on ALL FOUR controllers is lit and displaying a temperature when switched on. If any ONE of the controller displays two dashes (see fig.2) in the display repeat STEP 1.

This completes the activation procedure. Ignore question 2.

IF NO: You have 3 controllers or fewer, go to Question 2

Question 2: Is your water heater labeled "This appliance delivers water not exceeding 50°C in accordance with AS 3498" on the front cover?

IF YES: No further action is required.

IF NO: You will need to program the kitchen controller to enable selection of temperatures higher than 50°C

### Step 1

For the controller in the KITCHEN only, press and hold the 'Transfer' and 'On/Off' buttons simultaneously (see fig.1) until a 'beep' is heard (approximately 5 seconds).

### Step 2

When the controller fitted in the KITCHEN is switched on, it should be possible to select temperatures higher than 50°C. If not repeat STEP 1.

### NOTE

- If the kitchen controller is replaced, repeat STEP 1 above for the replacement controller
- If the kitchen controller is swapped with another controller (for example, the controller fitted in a bathroom, repeat STEP 1 for the controller moved from the kitchen to the bathroom. Then perform STEP 1 for the controller moved from the bathroom to the kitchen.