

# Rinnai

## Operation / Installation Manual

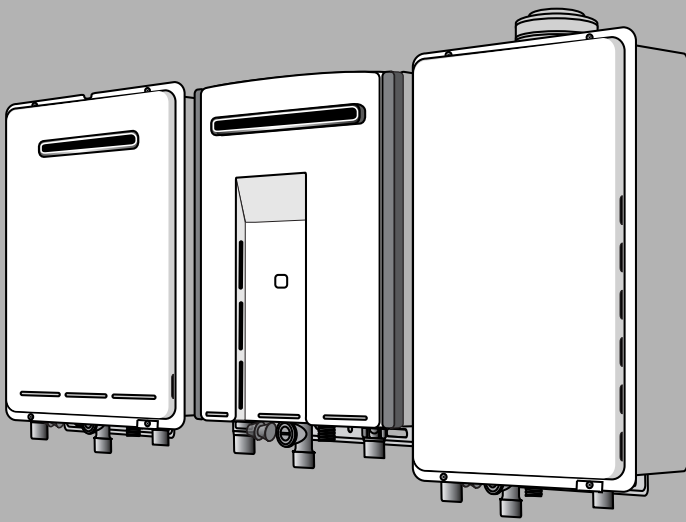

To Suit Models:  
Infinity XR 32  
Infinity XR26 Plus  
Infinity XR26  
Infinity XR24  
Infinity XR20 Plus  
Infinity XR20  
Infinity XR18  
Infinity XR16  
Infinity XR26i  
Infinity HD250  
Infinity HD250i  
Infinity HD200  
Infinity HD200i  
Efficiency24

How to use and install Rinnai continuous flow water heaters

**This appliance shall be installed in accordance with:**

- Manufacturer's Installation Instructions
- Current AS/NZS 3000, AS/NZS 3500 & NZS 5261
- Local Regulations and Municipal Building Codes

This appliance must be installed, serviced and removed by an Authorised Person.

# OPERATION MANUAL

<b>REGULATORY INFORMATION</b> .....	<b>1</b>
<b>WARNING ABOUT HOT WATER</b> .....	<b>1</b>
<b>FEATURES AND BENEFITS</b> .....	<b>2</b>
<b>IMPORTANT INFORMATION</b> .....	<b>3</b>
<b>OPERATION WITHOUT CONTROLLERS</b> .....	<b>5</b>
<b>GENERAL WATER CONTROL INFORMATION</b> .....	<b>6</b>
<b>UNIVERSAL WATER CONTROLLERS</b> .....	<b>7</b>
ABOUT THE UNIVERSAL WATER CONTROLLER (MC-91-2A) .....	7
TURNING ON THE CONTROLLER.....	7
ADJUSTING TEMPERATURE.....	7
HOW TO USE TWO OR MORE UNIVERSAL WATER CONTROLLERS .....	8
TRANSFERING PRIORITY.....	8
ADJUSTING TEMPERATURE.....	8
<b>DELUXE KITCHEN WATER CONTROLLERS</b> .....	<b>9</b>
ABOUT THE DELUXE KITCHEN WATER CONTROLLER (MC-70-2A/MC-100V) .....	9
HOW TO USE A SINGLE DELUXE WATER CONTROLLER.....	9
TURNING ON THE CONTROLLER.....	9
SETTING THE CLOCK.....	9
SETTING THE SOUND VOLUME .....	10
ADJUSTING TEMPERATURE.....	10
<b>DELUXE BATHROOM WATER CONTROLLERS</b> .....	<b>11</b>
ABOUT THE DELUXE BATHROOM WATER CONTROLLER (BC-70-2A/BC-100V) .....	11
HOW TO USE TWO OR MORE DELUXE WATER CONTROLLERS .....	12
TURNING ON THE CONTROLLERS .....	12
SETTING THE CLOCK (SEE PAGE 9 TO 10 FOR DETAILS ON HOW TO SET THE CLOCK) .....	12
SETTING THE SOUND VOLUME .....	12
ADJUSTING TEMPERATURE.....	12
OPERATING THE SHOWER SAVER / BATH FILL FUNCTION .....	13
COMBINING UNIVERSAL AND DELUXE CONTROLLERS .....	14
<b>TROUBLESHOOTING</b> .....	<b>15</b>
<b>WARRANTY STATEMENT - HOT WATER PRODUCTS</b> .....	<b>16</b>
<b>WARRANTY CONDITIONS</b> .....	<b>17</b>
<b>INSTALLATION MANUAL</b> .....	<b>18</b>
<b>ACCESSORIES</b> .....	<b>32</b>
<b>CONTACT INFORMATION</b> .....	<b>33</b>

# REGULATORY INFORMATION

Your Rinnai Continuous Flow water heater complies with NZS5262. A declaration to this effect can be found on the Energy Safety Service website; [www.ess.govt.nz](http://www.ess.govt.nz).

This Appliance must be installed correctly by an authorised person. The installation of gas, water, and electricity must conform to local regulations.

The installation must also comply with the instructions supplied by Rinnai.

All dimensions referred to in these instructions are in millimetres, unless otherwise specified.

Please keep this instruction booklet in a safe place for future reference.

# WARNING ABOUT HOT WATER



Excessively hot water is dangerous, especially for young children and the infirm. Rinnai Continuous Flow water heaters allow you to control the temperature of hot water to safe levels.

Water temperatures above 55°C can cause severe burns instantly and may even result in death. Those most at risk are children, disabled, elderly and the infirm. Hot water at 65°C (a very common hot water temperature in New Zealand ) can severely burn a child in less than half a second. At 55°C it takes half a minute.

#### **ALWAYS.....**

Test the temperature of the water with your elbow before placing your child in the bath, also carefully feel water before bathing or showering yourself.

Supervise children whenever they are in the bathroom.

Make sure that the hot water tap is turned off tightly.

#### **CONSIDER.....**

Installing child proof tap covers or child resistant taps (both approaches will prevent a small hand being able to turn on the tap).

Setting your appliance at a maximum temperature of 55°C (Contact Rinnai New Zealand).

#### **NEVER.....**

Leave a toddler in the care of another child. They may not understand the need to have the water temperature set at a safe level.

# FEATURES AND BENEFITS

Congratulations on purchasing the latest technology temperature controlled Rinnai continuous flow water heating system.

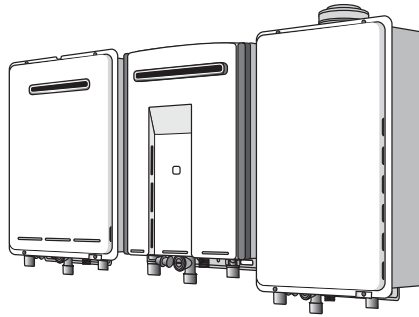

- The Rinnai Infinity and Infinity HD products NEVER RUN OUT of hot water. Whilst electricity, water and gas supplies are connected, hot water is available whenever hot water taps are open.
- Built into the main microprocessor is the facility to LIMIT THE MAXIMUM TEMPERATURE of the hot water supplied. The water temperature may be limited to various values. This is particularly useful when the hot water unit is installed where young children or the infirm may be using the hot water.
- The Rinnai Infinity, HD and Efficiency24 products are power flued appliances. This makes them COMPACT, saving both floor and wall space.
- The temperature of hot water is CONSTANTLY MONITORED by a BUILT-IN SENSOR. If the temperature of the hot water rises to more than 3°C above the selected temperature the burner is turned OFF and only turned ON again when the temperature falls below the selected temperature.
- The burner lights automatically when the hot water tap is opened, and goes out when the tap is closed. IGNITION IS ELECTRONIC, so there is no pilot light. When the hot water tap is off, no gas is used.
- 'Deluxe' or 'Universal' Water Controllers are available as an optional extra. Depending on the models chosen, these offer the following features:
  - Bath fill function (Deluxe Bathroom Control Only).
  - Voice Prompting (Deluxe Control Only).
  - Clock (Deluxe Control Only).
  - Up to four water controllers can be fitted. See page 6 for details.
  - Water controller cables are connected easily by the end user using a convenient quick connect system.
- Operating NOISE LEVEL IS VERY LOW.
- ERROR MESSAGES ARE DISPLAYED on the Water Controllers and Status Monitor\*, assisting with service. \*Status Monitor available on Infinity XR26 Plus, XR20 Plus, Infinity HD250, HD250i, HD200 and HD200i models only.



**The range of Rinnai continuous flow water heaters referred to in this manual are incompatible with solar water heating systems. A dedicated range of solar compatible continuous flow water heaters is available from Rinnai.**

# IMPORTANT INFORMATION

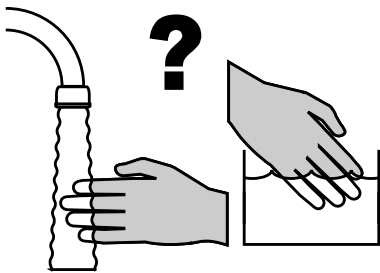

Always check water temperature carefully before use. Refer to the **WARNING ABOUT HOT WATER** on "page 1" of this manual for important safety information.

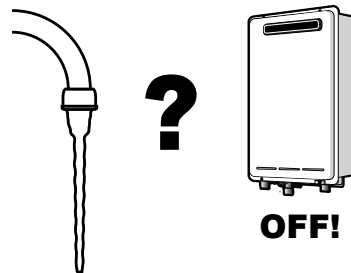

At low water flows, the hot water unit may extinguish without warning. Opening the tap further will restart the appliance.

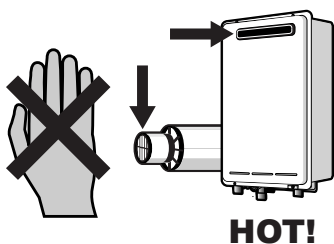

**Do Not** touch the unit cover or the flue outlet.  
**Do Not** insert objects into the flue outlet.

On colder days steam may discharge from the flue outlet. This condition is normal for high efficiency appliances and does not indicate a fault.



Keep flammable materials, spray cans, fuel containers, pool chemicals, trees, shrubs, etc. well clear of the flue outlet.

**Do Not** spray water directly into the flue terminal.

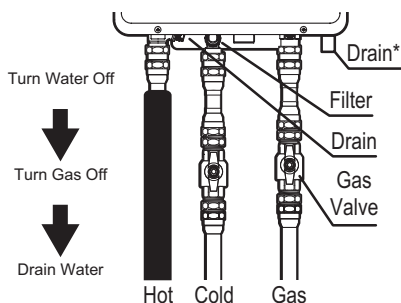

Anti frost protection is fitted as standard equipment on all LPG models and is available as an optional extra on all natural gas models.

If natural gas units are installed into areas where freezing conditions are experienced, the optional automatic anti frost protection system should be fitted. The anti frost protection system operates automatically as required whenever the appliance is connected to the electric power supply.

If the appliance is not going to be used for an extended period and it is desired that the electric power supply is disconnected, turn off the water and gas supplies and arrange for your plumber to drain all water from the appliance to prevent frost damage.

Drain\*: applies only to the Efficiency (REU-K2430WG) model.

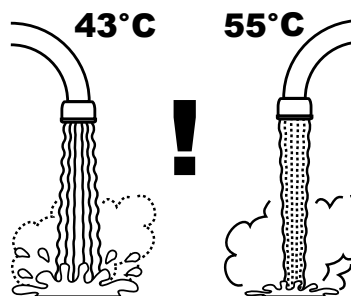

The delivered water temperature is controlled automatically. The flow may vary depending on the delivery temperature selected and the ambient water temperature.

# IMPORTANT INFORMATION

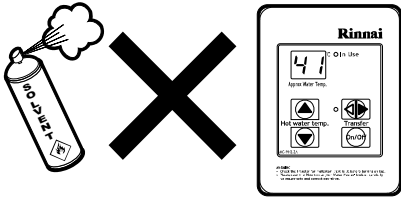

To clean your water controller(s) use a soft damp cloth with a mild detergent.

**Do Not** use solvents!

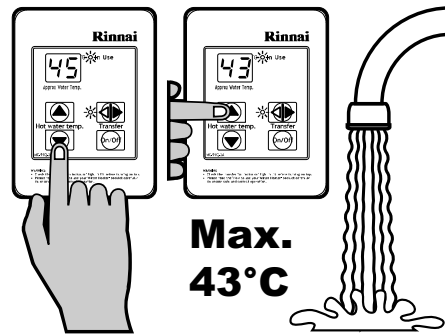

Whilst hot water outlets are open the set temperature may be lowered. However they cannot then be raised above 43°C. In addition transfer of 'priority' between controllers is not possible. These are safety features.

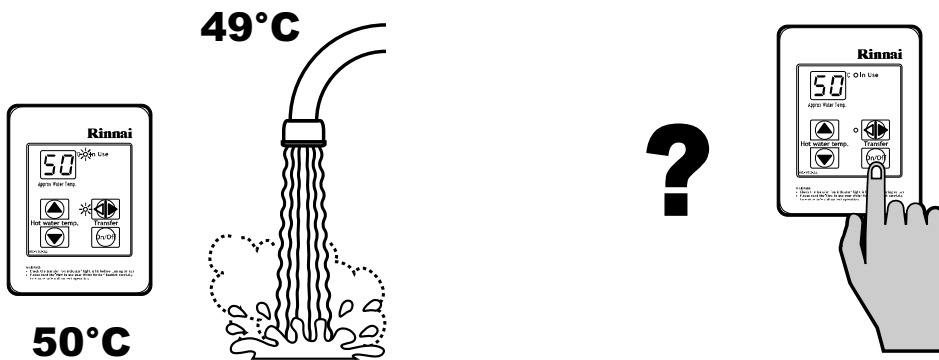

Depending on the weather conditions and the length of the pipe between the hot water unit and the outlet in use, there may be a variation between the temperatures displayed at the water controller(s) and the temperature of the water at the outlet.

There is no need to turn the water controller(s) off after use. However, if you prefer to turn the water controller(s) off, selected temperatures to a maximum of 50°C will be stored in the system memory at all times whilst mains power remains connected.

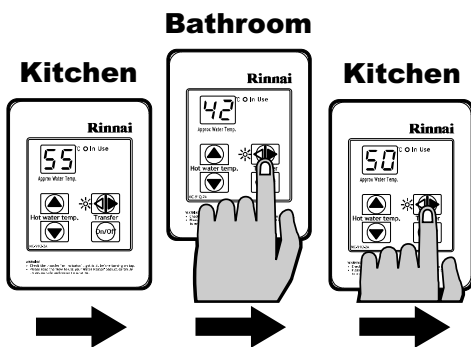

As a safety precaution, if a Kitchen Controller's temperature is set above 50°C, transferring and then returning 'priority' to the Kitchen Controller will result in a default set temperature of 50°C being selected. This is a safety feature.

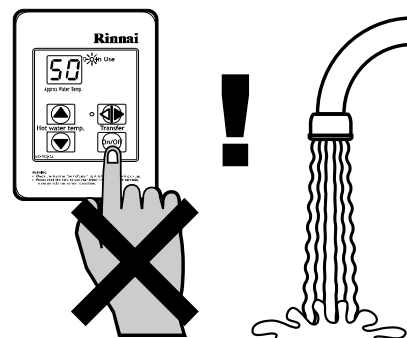

**Do Not** push the On/Off button on any Controller when the 'Red' water heater 'In Use' indicator is illuminated as this will turn off the water heater causing the water to go cold. Someone maybe in the middle of having a shower or filling a bath.

# OPERATION WITHOUT CONTROLLERS

Rinnai Infinity and Infinity HD continuous flow water heater products do not use a pilot light.

When installed and operated without water controllers, the opening of any hot water tap will automatically start the appliance.

Once water is flowing through the appliance the burner will be ignited by electronic ignition.

When the hot water tap is closed and water flowing through the appliance has stopped the burner flame will extinguish.

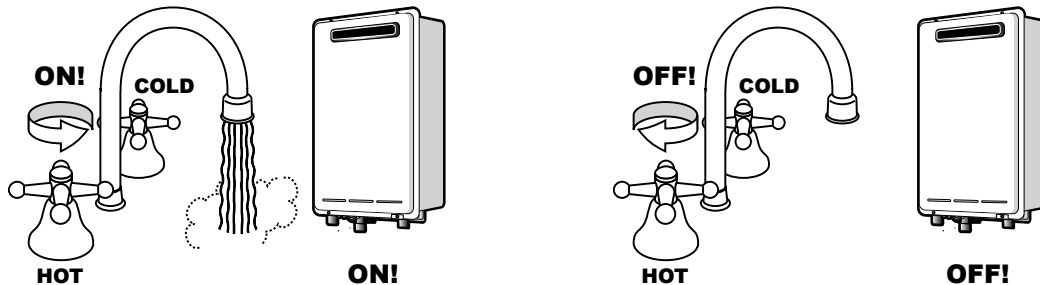

The Rinnai Infinity range of water heaters are factory pre-set to a temperature limit of 55°C. Rinnai Infinity HD series are factory pre-set to a temperature limit of 75°C. Other limits, lower or higher, are available on request for both the Infinity and HD range. Temperature controllers are available to allow precise digital temperature control.

Controllers can be fitted at any time after installation of the hot water unit.



Excessively hot water is dangerous, especially where young children and the infirm are concerned. Rinnai continuous flow water heaters allow you to control the temperature of your hot water to safe levels.

Water temperatures above 55°C can cause severe burns instantly, such as scalding and may even result in death. Those most at risk are children, disabled, elderly and the infirm. Hot water at 65°C (a very common water temperature in New Zealand) can severely burn a child in less than half a second. At 55°C it takes a half minute.

## ALWAYS.....

Test the temperature of the water with your elbow before placing your child in the bath, also carefully feel water before bathing or showering yourself.

Supervise children whenever they are in the bathroom.

Make sure that the hot water tap is turned off tightly.

## CONSIDER.....

Installing child proof tap covers or child resistant taps (both approaches will prevent a small hand being able to turn on the tap).

Setting your appliance at a maximum temperature of 55°C (Contact Rinnai New Zealand).

## NEVER.....

Leave a toddler in the care of another child. They may not understand the need to have the water temperature set at a safe level.

# GENERAL WATER CONTROL INFORMATION

Remote water controllers allow precise temperature control by the user. When used correctly, the hot water unit will deliver the selected temperature, even when the water flow is varied, or more than one tap is in use. Each water controller can be individually programmed, however the water heater can only deliver one set temperature at any time. The available temperatures (°C) are as follows:

## Kitchen Controller:

37, 38, 39, 40, 41, 42, 43, 44, 45, 46, 48, 50, 55°C\* ( 60, 65, 75°C Infinity HD models only )

## Bathroom Controller:

Hot Water Delivery: 37, 38, 39, 40, 41, 42, 43, 44, 45, 46, 48, 50°C

Bath fill Delivery: 37, 38, 39, 40, 41, 42, 43, 44, 45, 46, 47, 48°C

Whilst hot water outlets are open the set temperature may be lowered. However the set temperature cannot then be raised above 43°C. In addition, transfer of 'priority' between water controllers is not possible. These are safety features.

## Suggested temperatures are:

Kitchen 50°C ~ 55°C\* Shower 37°C ~ 43°C, Bath fill 39°C ~ 45°C

*\* Temperature may not be available on all installations. Rinnai water heaters can be programmed to deliver higher temperatures via the kitchen water controller. Contact Rinnai for more details.*

These temperatures are suggestions only. You may find higher or lower temperatures more comfortable. Maintaining lower temperatures helps save energy. To obtain water temperatures lower than 37°C simply add cold water.

Water controllers are an optional extra. 'Universal', 'Deluxe', and 'Wireless' water controllers can be fitted. Universal water controllers allow temperature selection only. Deluxe water controllers allow temperature selection, shower saver / bath fill, voice prompting and have a clock function.

Water controllers allow the water temperature to be set from the various locations where they are installed. The temperature selected will be available to all outlets.

## Universal (MC-91-2A), Deluxe (MC/BC-70-2A and MC/BC-100V) and Wireless Water Controllers - available configurations:

<p><b>Wired and Wireless Installations</b></p>	<p>A maximum of 4 water controllers can be fitted. Any combination of deluxe, universal and wireless controllers can be used with the following limitations:</p> <p><b>Only ONE master controller can be installed. This can be a MC-70V/MC-100V, a MC-91 (when programmed as a master controller) or a MC502S (wireless) water controller.</b></p> <p><b>Up to TWO BC-70V/BC-100V water controllers can be installed.</b></p> <p><b>The FOURTH water controller in any installation MUST BE a MC502S (wireless) or a MC-91.</b></p>
--	--



# UNIVERSAL WATER CONTROLLERS

## ABOUT THE UNIVERSAL WATER CONTROLLER (MC-91-2A)

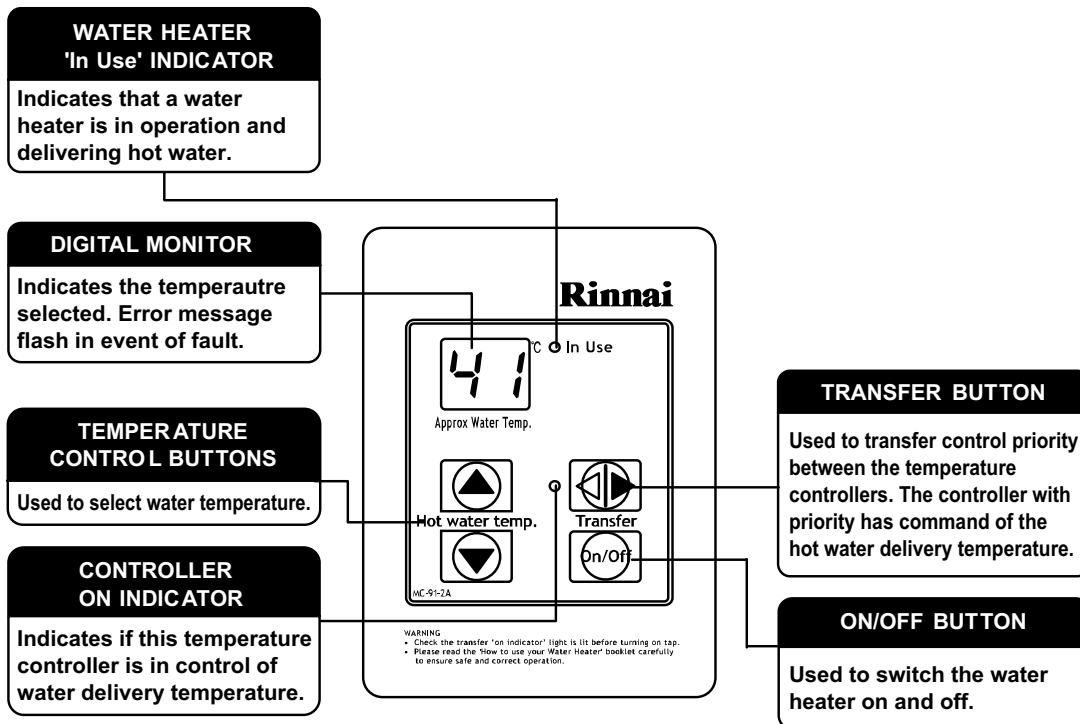

### TURNING ON THE CONTROLLER

If the water controller is switched off (No digits displayed in the digital monitor window) press the On/Off button once.

The ON indicator will illuminate, indicating that the hot water unit will be ready to supply hot water once a hot water tap is opened.

### ADJUSTING TEMPERATURE

Select the desired temperature using the 'Hot water temp' ▲ or ▼ buttons until the required temperature is displayed on the digital monitor.

To operate the hot water unit, open any hot water tap. This will automatically light the burner providing hot water. The water heater 'In Use' indicator will illuminate on the water controller.

Once the hot water is running, if the set temperature is either too hot or cold press the 'Hot water temp' ▲ or ▼ buttons until the desired temperature is reached.

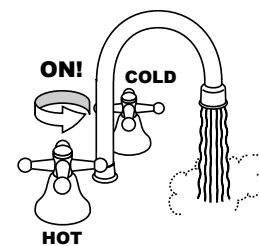
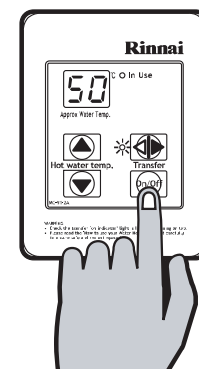

#### CHECK WATER TEMPERATURE BEFORE USE.

A parent or carer should always check the temperature before a child is placed in contact with hot water, see page 5.



Whilst hot water outlets are open the set temperature may be lowered. However they cannot then be raised above 43°C. In addition, transfer of 'priority' between controllers is not possible. These are safety features.

The 'beep' sound can be muted by pressing the 'Hot water temp' Up ▲ and Down ▼ buttons simultaneously for more than 3 seconds.

# UNIVERSAL WATER CONTROLLERS

## HOW TO USE TWO OR MORE UNIVERSAL WATER CONTROLLERS

### TURNING ON THE CONTROLLERS

If the controllers are switched off (No digits displayed in the digital monitor window) press the On/Off button once at any controller.

The ON indicator on the desired controller will illuminate, indicating that the hot water unit will be ready to supply hot water once a hot water tap is opened.

### TRANSFERING PRIORITY

An illuminated On/Off indicator confirms that the desired controller is in control of the water delivery temperature, if the On/Off indicator is not illuminated press the Transfer button once.

The On/Off indicator on the controller will now illuminate indicating that hot water temperature control has now been transferred to this controller and that the hot water unit will be ready to supply hot water once a hot water tap is opened.

### ADJUSTING TEMPERATURE

Select the desired temperature using the 'Hot water temp' ▲ or ▼ buttons until the required temperature is displayed on the digital monitor.

To operate the hot water unit, open any hot water tap. This will automatically light the burner providing hot water. The water heater 'In Use' indicator will illuminate on the water controller.

Once the hot water is running, if the set temperature is either too hot or cold press the 'Hot water temp' ▲ or ▼ buttons until the desired temperature is reached.

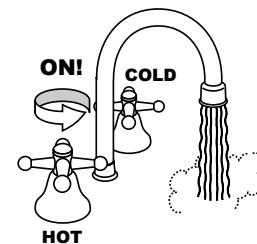
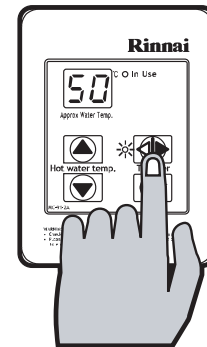
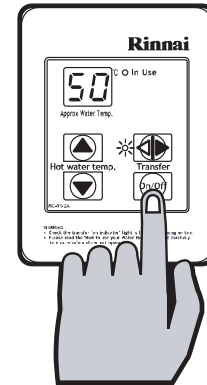

### CHECK WATER TEMPERATURE BEFORE USE.

A parent or carer should always check the temperature before a child is placed in contact with hot water, see page 5.



Whilst hot water outlets are open the set temperature may be lowered. However they cannot then be raised above 43°C. In addition transfer of 'priority' between controllers is not possible. These are safety features.

Temperatures higher than 55°C should not be able to be selected on controllers installed in bathrooms, ensuites or toilets. This is to help reduce the risk of burns from hot water. If this is not the case, the controllers have been incorrectly installed. CONTACT YOUR INSTALLER.

The temperature of outgoing hot water is constantly monitored by a built-in sensor. If the temperature of the outgoing hot water rises to more than 3°C above the selected temperature shown on the digital monitor or the pre-set limit when water controllers are not fitted, the burner will automatically go out. The 'in use' indicator will also go out. The burner will ignite again once the outgoing hot water temperature falls to that shown on the digital monitor (or the pre-set limit of the appliance).

# DELUXE KITCHEN WATER CONTROLLERS

## ABOUT THE DELUXE KITCHEN WATER CONTROLLER (MC-70-2A/MC-100V)

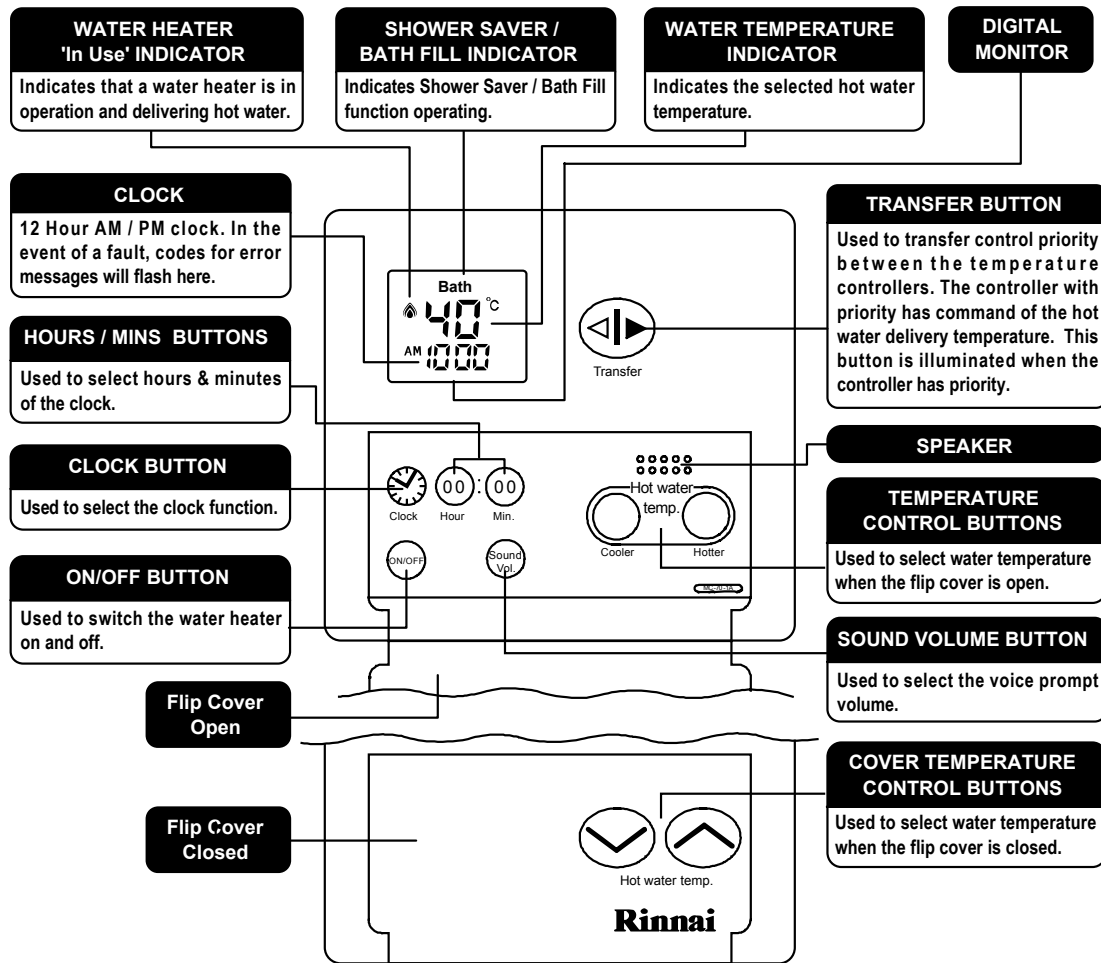

## HOW TO USE A SINGLE DELUXE WATER CONTROLLER

When using a single Deluxe Water Controller, the Deluxe Kitchen Water Controller (MC-70-2A/MC-100V) must be fitted.

### TURNING ON THE CONTROLLER

If the controller is switched off (No digits other than the clock digits displayed in the digital monitor window) press the On/Off button once.

The Transfer button of the controller will illuminate, indicating that the hot water unit will be ready to supply hot water once a hot water tap is opened.

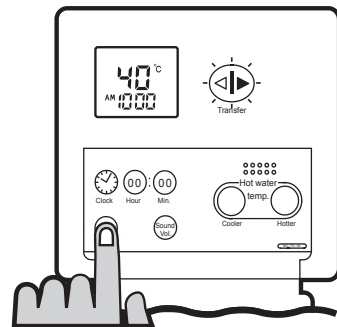

**NOTE** Each time a button is pressed, a 'beep' will sound. The 'beep' sound and the 'bath fill complete' buzzer can be muted by pressing the Temperature Controller Up and Down buttons simultaneously for more than 3 seconds. To return to original settings, repeat this step.

Avoid getting water in the speaker as this may cause damage.

### SETTING THE CLOCK

The clock is a 12 hour AM/PM style display. To set the time press the 'Clock'  button once, the clock digits in the digital monitor will flash AM 12:00 in the clock setting mode.

# DELUXE KITCHEN WATER CONTROLLERS

Set the time with the 'Hour' and 'Min.' (00) buttons. Holding these buttons down continuously cycles the digits. When you get close to the time you wish to set, press the button intermittently to avoid going further than the desired time.

Press the 'Clock' button again to complete setting the clock and return to normal operation.

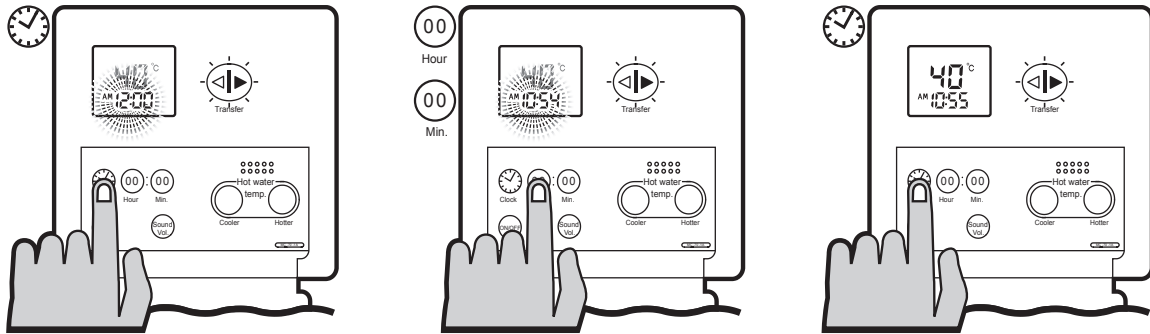

**The time is always displayed regardless of whether the Water Controller is turned ON or OFF.**

**The clock may need to be reset if the power supply to the water heater unit is disrupted by either the power being turned off or due to a power failure.**

## SETTING THE SOUND VOLUME

The 'Sound Vol.' button controls the voice prompt volume. Note there are no voice prompts when a single Deluxe Kitchen Water controller is installed.

## ADJUSTING TEMPERATURE

Simply press the 'Hot water temp' (up/down) buttons until the required temperature is displayed on the Digital Monitor.

To operate the hot water unit, open any hot water tap. This will automatically light the burner providing hot water. The red flame of the water heater 'In Use' indicator (flame icon) will illuminate on the Water Controller.

Once the hot water is running, if the set temperature is either too hot or cold press the 'Hot water temp' (up/down) buttons until the desired temperature is reached.

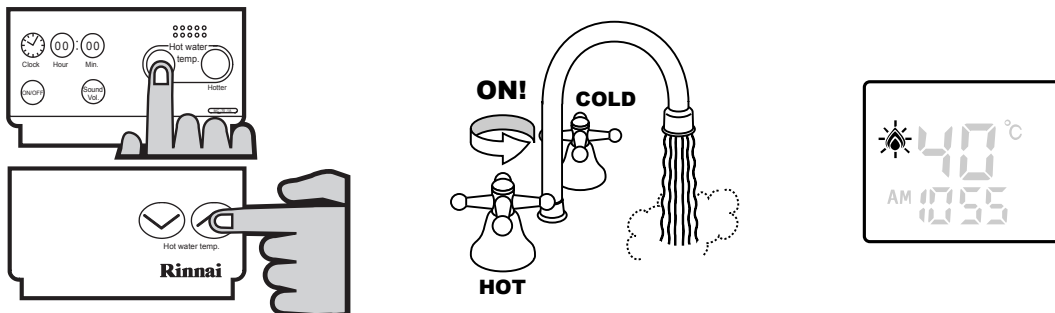

### **CHECK WATER TEMPERATURE BEFORE USE.**

**A parent should always check the temperature before a child is placed in contact with hot water.**



**Whilst hot water outlets are open the set temperature may be lowered. However they cannot then be raised above 43°C. In addition transfer of 'priority' between controllers is not possible. These are safety features.**

# DELUXE BATHROOM WATER CONTROLLERS

## ABOUT THE DELUXE BATHROOM WATER CONTROLLER (BC-70-2A/BC-100V)

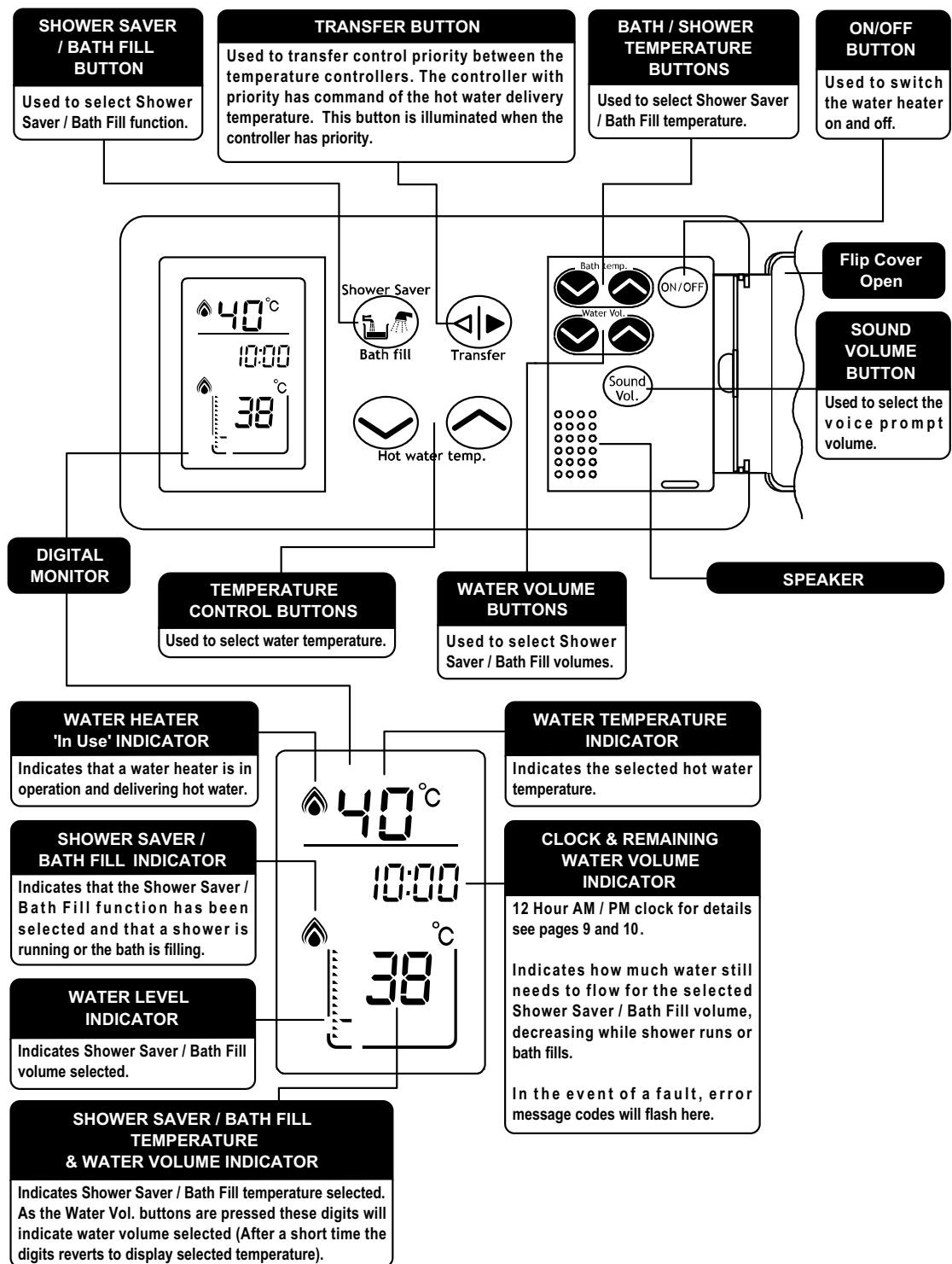

NOTE

Each time a button is pressed, a 'beep' will sound. The 'beep' sound and the 'bath fill complete' buzzer can be muted by pressing the Water Controller Up and Down buttons simultaneously for more than 3 seconds. This can be done for each Water Controller. To return to original settings, repeat this step.

Avoid getting water in the speaker as this may cause damage.

# DELUXE BATHROOM WATER CONTROLLERS

## HOW TO USE TWO OR MORE DELUXE WATER CONTROLLERS

When using two or more Deluxe Water Controllers, only one Deluxe Kitchen Water Controller (MC-70-2A/MC-100V) can be fitted, see page 6 to confirm the maximum number and type of remote controllers that can be fitted to your water heater model.

## TURNING ON THE CONTROLLERS

If the controllers are switched off (No digits displayed in the digital monitor other than the clock for the Deluxe Kitchen controller) press the ON/OFF button once at any controller. The Transfer Button (◀▶) at the selected controller will illuminate, indicating that the hot water unit is ready to supply hot water when a tap is open.

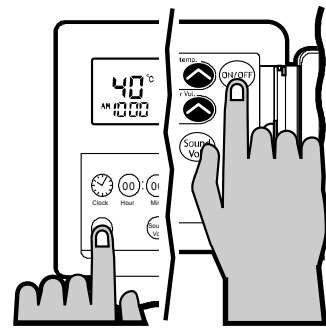

## SETTING THE CLOCK (SEE PAGE 9 TO 10 FOR DETAILS ON HOW TO SET THE CLOCK)



The time is displayed on all the Deluxe Controller(s) when the controllers are on. When the controllers are OFF, the time is only displayed at the Kitchen Controller. After a power failure the clock may need to be reset.

## SETTING THE SOUND VOLUME

The voice prompt sound volume for all Deluxe Water Controllers can be set individually. To do this press the 'Sound Vol.' Button (Speaker icon) located behind the flip panel once.

The default voice prompt sound volume is medium, each subsequent press of the 'Sound Vol.' Button will cycle through the available volume settings in the following order: High - Off - Low - Medium.

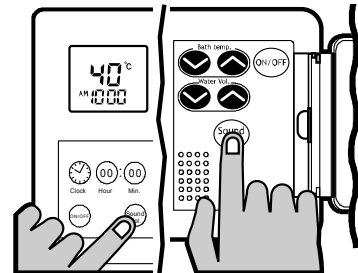

## ADJUSTING TEMPERATURE

Simply press the 'Hot water temp' Up or Down buttons until the required temperature is displayed on the Digital Monitor.

To operate the hot water unit, open any hot water tap. This will automatically light the burner providing hot water. The water heater 'In Use' indicator (flame icon) will illuminate on all Water Controllers.

Once the hot water is running, if the set temperature is either too hot or cold press the 'Hot water temp' Up or Down buttons until the desired temperature is reached.

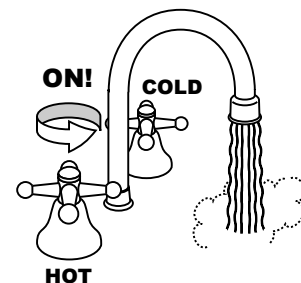
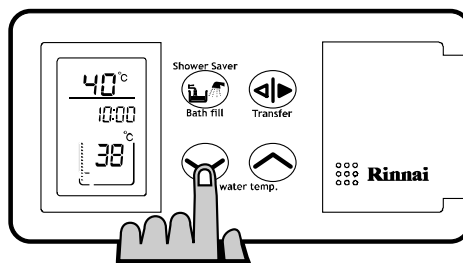
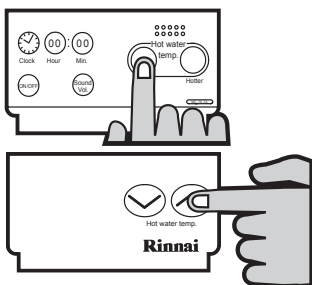

### CHECK WATER TEMPERATURE BEFORE USE.

A parent should always check the temperature before a child is placed in contact with hot water.



Whilst hot water outlets are open the set temperature may be lowered. However they cannot then be raised above 43°C. In addition transfer of 'Priority' between controllers is not possible. These are safety features.

# DELUXE BATHROOM WATER CONTROLLERS

## OPERATING THE SHOWER SAVER / BATH FILL FUNCTION

The 'Shower Saver / Bath Fill' function allows a preset water volume and temperature to be selected and run automatically.

### Initial Settings

When a deluxe bathroom controller is first turned on, the default shower / bath fill temperature is set to 40°C and the shower / bath volume is set to 100 litres. The shower / bath volume can be lowered to a minimum of 30 litres or raised to a maximum of 400 litres.

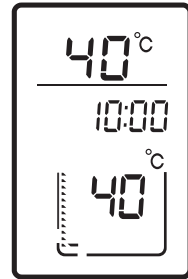

### Programming Shower / Bath volume and Temperature

With the system on, select a Deluxe Bathroom controller and ensure that it currently has priority. If it does not have priority press the Transfer (◀▶) button once and the Transfer button will illuminate.

To select the desired delivery temperature use the 'Shower / Bath temp.' (▲) or (▼) buttons located behind the flip panel.

The selected temperature will be displayed at the bottom of the bathroom controller monitor and will remain as the default temperature until it is changed or if the mains power is turned off.

To select the volume of water to be used by the shower / bath use the 'Water Vol.' (▲) or (▼) buttons that are located directly below the 'Shower / Bath temp.' buttons located behind the flip panel.

The selected volume is displayed at the bottom of the controller monitor numerically, and graphically by the long bar against the level markers.

When filling a bath for the first time, it is recommended that a low bath fill volume such as 100 litres or lower be used. During any subsequent bath fills the volume can then be adjusted to suit your known bath volume and or desired fill level.

The long bar and the level markers are used to graphically represent the current shower / bath volume in litres. The examples to the right show shower / bath volumes set to 60, 120 and 240 litres.

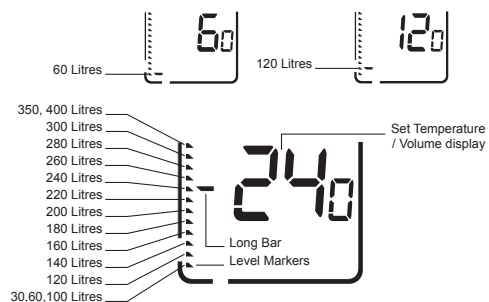
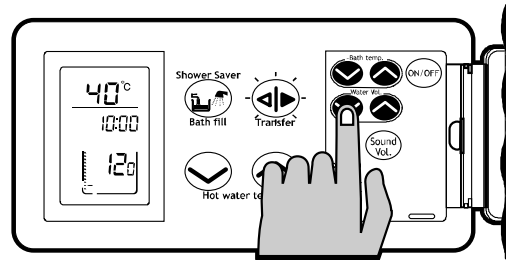
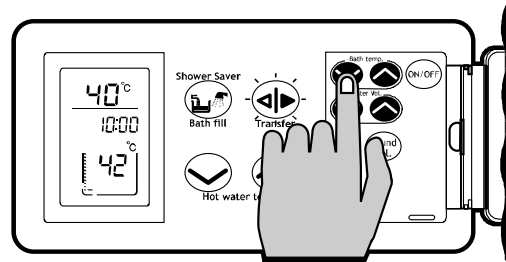

**Remember that the bath level markers on the display are not a true representation of your bath. i.e. the 'half-way' mark on the monitor is not necessarily the 'half-way' point on your bath.**

**Be careful not to overfill the bath, an average bath volume is 160 litres. It is recommended that when filling a bath for the first time you should:**

- Remain by the bath during the filling process.
- Use a low bath fill volume such as 100 litres or less.

# DELUXE BATHROOM WATER CONTROLLERS

## Using Shower Saver / Bath Fill

Press 'Shower Saver / Bath Fill'  button once. The 'Shower Saver / Bath Fill' button will illuminate and a tone will sound. The 'Bath' indicator will also be displayed in the Kitchen Controller monitor.

The voice prompt will say "The hot water system is ready. Open the hot water tap".

Open the hot water tap for the relevant shower or bath.

The 'In Use' indicator  will illuminate at all Deluxe Water Controller(s) and the shower will run or the bath will start to fill.

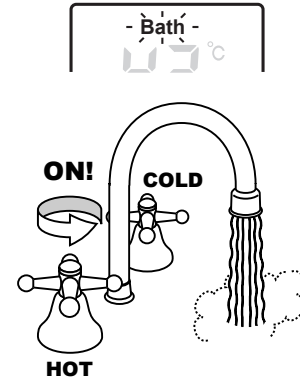

## To Stop Shower Saver / Bath Fill Operation

If you wish to stop the water flow whilst the shower saver / bath fill function is in operation, simply press the 'Shower Saver / Bath Fill'  button. The 'Shower Saver / Bath Fill' button will flash and the voice prompt will say "Hot water is not available, Turn off all hot water taps and push the 'Bath Fill' button". Follow the voice prompt instructions.

## When Shower Saver / Bath Fill Operations Finishes

Once the shower saver / bath fill operation finishes the following events will occur:

1. The flow from the shower / bath hot water tap will cease.
2. The 'Shower Saver / Bath Fill' button will flash.
3. The Kitchen Controller 'Bath' indicator will flash.
4. A tone will sound.
5. The voice prompt will say "Bath Fill is complete. Turn off the bath hot water tap and push the Bath Fill button."

Follow the voice prompt instructions. Note that the hot water unit will not allow hot water to flow from any fixture until the 'Shower Saver / Bath Fill' button has been pressed.

6. The 'Shower Saver / Bath Fill' button light on the Bathroom Controller and the 'Bath' indicator on the Kitchen Controller monitor will go out.

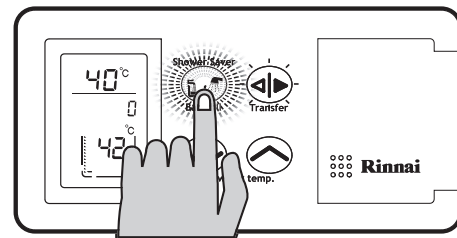
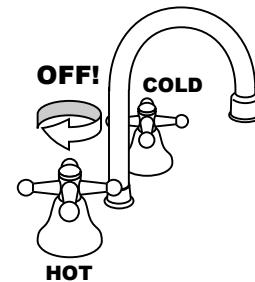

### CHECK WATER TEMPERATURE BEFORE USE.

A parent should always check the temperature before a child is placed in contact with hot water.

### NEVER LEAVE YOUNG CHILDREN UNATTENDED IN THE BATH.

When using the 'Shower Saver / Bath Fill' function, ALWAYS close the hot water tap for the bath or shower after the flow has stopped.



Whilst hot water outlets are open the set temperature may be lowered. However they cannot then be raised above 43°C. In addition transfer of 'priority' between controllers is not possible. These are safety features.

## COMBINING UNIVERSAL AND DELUXE CONTROLLERS

Universal and Deluxe Controllers can be combined and will function as described in other sections of this manual. Refer to the table on page 6 to confirm the maximum number and combination of controllers that can be fitted to your Water Heater model.



# TROUBLESHOOTING

Your Rinnai continuous flow water heaters has a self diagnostic capability. If a fault occurs, an Error Code will flash on the digital monitor or status monitor\* if you have water controllers. This assists with diagnosing the fault, and may enable you to overcome a problem without a service call. Please quote the code displayed when enquiring about service. \*Status Monitor available on Infinity XR26 Plus and XR20 Plus, Infinity HD250, HD200 and HD200i models only.

ERROR	FAULT	REMEDY
-	Noticeable reduction in water flow.	Inlet water filter needs to be cleaned. Service call.
03	Power interruption during Bath fill (Water will not flow on power reinstatement).	Turn off all hot water taps. Press On/Off twice.
10	Air intake or flue blocked.	Service Call.
11	No ignition / No gas supply.	Check gas is turned on at water heater and gas meter or cylinder.
12	Flame Failure / Low gas flow.	Check gas is turned on at water heater and gas meter or cylinder. Check there are no obstructions to the flue outlet.
14	Over Heat Thermal Fuse.	Service Call.
16	Over Temperature Warning.	Service Call.
32	Outgoing Water Temperature Sensor Faulty.	Service Call.
33	Heat Exchanger Outlet Sensor Faulty.	Service Call.
34	Combustion Air Temperature Sensor Faulty.	Service Call.
52	Gas Modulating Valve Faulty.	Service Call.
61	Combustion Fan Failure.	Service Call.
65	Water Flow Control Faulty (Does not stop flow properly).	Service Call.
71	Microprocessor Failure.	Service Call.
72	Microprocessor Failure.	Service Call.

In all cases, you may be able to clear the Error Code simply by turning the hot water tap OFF, then ON again. If this does not clear the Error Code, try pushing the On/Off button OFF, then ON again. If the Error Code still remains, contact Rinnai for advice.

## Troubleshooting Without Controllers

If you have no water controllers and experience the following symptoms, carry out these suggestions. If the symptom continues, contact Rinnai for advice.

FAULT	REMEDY
The unit does not attempt to start at all.	Check the power is on at the unit. Check the isolation valves at the unit are open.
The unit starts then shuts down immediately.	Check the power is still on. Check the gas isolation valves at the unit and the gas meter are fully open. Open your hot water tap fully.
The unit starts then the water goes cold.	Check the power is still on. Open your hot water tap fully.



**Faults caused by insufficient gas supply, insufficient water supply, gas quality, water quality, installation errors or operation errors are not covered by the Rinnai warranty. Refer to Warranty Conditions page 16 and page 17.**

# WARRANTY STATEMENT - HOT WATER PRODUCTS

## RINNAI BRINGS YOU PEACE OF MIND WITH A 3 YEAR MINIMUM WARRANTY

### Rinnai Infinity 3 Year Warranty - Terms and Conditions

1. During the 36 month period from date of purchase and subject to clauses 2 and 3 below, Rinnai New Zealand Limited ("Rinnai") will, at its own discretion, either replace or repair any defective product at no charge to the customer.
2. This warranty covers manufacturing defects only. This warranty will not apply if (for example) the product has been improperly installed or is otherwise installed contrary to manufacturer's recommendations, has been damaged during installation, has not been operated in accordance with operating instructions, or has been subjected to damage or abuse beyond that expected from conditions of normal use.
3. Warranty claims may be invalid if not accompanied by details of the installing or supervising gas fitter's registration number and the gas fitting certification number.
4. This warranty commences from the date of purchase. Proof of purchase is required at the time of any warranty claim.
5. Servicing of the product is to be carried out by a Rinnai authorised service centre.

### Extended Warranty for Rinnai Infinity Heat Exchanger

The warranty on heat exchangers in Rinnai infinity in domestic use is 10 years pro rata (i.e. in the 4<sup>th</sup> year, 70% of the value of the part is covered and 40% in the 7<sup>th</sup> year).

For Rinnai infinity units installed for commercial use the warranty for the heat exchanger is 5 years pro rata (i.e. in the 4<sup>th</sup> year, 40% of the value of the part is covered and 20% in the 5<sup>th</sup> year).

This warranty is subject to Terms and Conditions 2 to 5 above.

All other parts and labour for the product are covered for 3 years in accordance with the Terms and Conditions above.

### Water Quality

Water quality outside the maximum recommended limits as set down in the customer's handbook will void this warranty. Proof of purchase may be required for a warranty claim to be valid. [Water quality] tests will be carried out at the customer's own cost but Rinnai will reimburse the customer for those costs if the product is found to be defective.

All Rinnai appliances meet or exceed the safety standards required by New Zealand gas and electrical regulations. Rinnai is constantly improving its products and as such specifications are subject to change or variation without notice.

# WARRANTY CONDITIONS

## WARRANTY CONDITIONS

1. Dated proof of purchase is required to be shown to the attending service technician prior to the commencement of any warranty work.
2. All Rinnai water heaters must be installed in accordance with the Manufacturer's Installation Instructions, current AS/NZS3000, AS/NZS3500 and NZS5261, local regulations and municipal building codes.
3. All Rinnai water heaters must only be installed, commissioned and removed by persons Authorised by local regulations to do so. All Rinnai water heaters must only be serviced and repaired by a Rinnai approved service technician.
4. Where the water heater has not been sited in accordance with the Installation Instructions or installed such that normal service access is difficult, a service charge may apply. At the discretion of the attending service technician, if access is deemed dangerous service will be refused.
5. Where a failed component is replaced under warranty, the balance of the original appliance warranty will remain effective.
6. Water chemistry and impurity levels must be within the limits specified in Tables 2 below:

**Table 2: Water chemistry and impurity limits - Infinity and HD models**

TDS (Total Dissolved Solids)	Total Hardness CaCO <sub>3</sub>	Alkalinity (as CaCO <sub>3</sub> )	Dissolved (free) CO <sub>2</sub>	pH	Chlorides	Magnesium	Sodium	Iron
Up to 600 mg/litre or ppm	Up to 200 mg/litre or ppm	Up to 200 mg/litre or ppm	Up to 25 mg/litre or ppm	6.5 to 8.5	Up to 300 mg/litre or ppm	Up to 10 mg/litre or ppm	Up to 150 mg/litre or ppm	Up to 1 mg/litre or ppm

## WARRANTY EXCLUSIONS:

The following exclusions may cause the warranty to become void and may incur a service charge and costs of parts (if required):

1. Accidental damage, acts of God, failure due to misuse, incorrect or unauthorized installations, attempts to repair the heater other than by a Rinnai approved service technician.
2. Where it is found that there is no fault with the water heater and the issue is related to the plumbing installation or due to the failure of water, electric or gas supplies.
3. Where the water heater has failed directly or indirectly as a result of excessive water pressure, negative water pressure (partial vacuum) or water pressure pulsation.
4. Subject to any statutory provisions to the contrary, claims for damage to walls, foundations etc. or any other consequential loss either directly or indirectly due to leakage from the water heater or any other faults.
5. This warranty does not cover the effects of sludge and sediment as a result of connection to a water supply from unfiltered sources such as a spring, dam, bore, river, or the entry of sludge & sediment into the water supply for any other reason.

Rinnai does not accept liability for consequential damage or any incidental expenses resulting from any breach of the warranty.

-----  
**Please record the following information below for your own records.**

Your Retailer : \_\_\_\_\_  
 Address : \_\_\_\_\_ Phone : \_\_\_\_\_  
 Purchase Date : \_\_\_\_\_  
 Your Installer : \_\_\_\_\_ Installers License No : \_\_\_\_\_  
 Address : \_\_\_\_\_ Phone : \_\_\_\_\_  
 Installation Date : \_\_\_\_\_ Cert' of Compliance No : \_\_\_\_\_  
 Model No : REU-\_\_\_\_\_ Serial No : \_\_\_\_\_

# INSTALLATION MANUAL

<b>GENERAL INSTALLATION INSTRUCTIONS .....</b>	<b>19</b>
REGULATIONS .....	19
APPLICABLE MODELS .....	19
APPLIANCE LOCATION .....	19
PIPE SIZING .....	20
WATER SUPPLY .....	20
HOT WATER DELIVERY TEMPERATURE .....	20
MOUNTING THE APPLIANCE .....	20
REQUIREMENTS FOR INFINITIES INSTALLED WITHOUT CONTROLLERS .....	21
SERVICE CONNECTION POINTS .....	21
MULTIPLE INSTALLATIONS OF EXTERNAL MODELS .....	22
APPLIANCE DIMENSIONS .....	23
<b>CONDENSATE DRAIN (REU-K2430WG ONLY).....</b>	<b>24</b>
IMPORTANT CONSIDERATIONS FOR THE CONDENSATE DRAIN PIPE .....	24
LENGTH AND CHANGES OF DIRECTION .....	24
INSTALLATION .....	24
INTERCONNECTION OF CONDENSATE DRAIN LINES .....	25
COMMON STACK DISCHARGE .....	25
TUNDISH DRAIN LINES .....	25
AREAS SUBJECT TO FREEZING .....	25
<b>WATER CONTROLLER INSTALLATION.....</b>	<b>26</b>
RINNAI WATER CONTROLLERS .....	26
POSITIONING OF WATER CONTROLLERS .....	26
WATER CONTROLLER CABLES .....	26
FITTING THE 'UNIVERSAL' WATER CONTROL (MC-91-2A) .....	26
OPTIONAL PROGRAMMING FOR THE 'UNIVERSAL' WATER CONTROLLER (MC-91-2A) .....	27
FITTING THE 'DELUXE KITCHEN' WATER CONTROLLER (MC-70-2A/MC-100V) .....	27
FITTING THE 'DELUXE BATHROOM' WATER CONTROLLER (BC-70-2A/BC-100V) .....	28
CONNECTING COMMUNICATION CABLES TO THE WATER HEATER .....	29
<b>COMMISSIONING .....</b>	<b>30</b>
TESTING .....	30
GAS PRESSURE SETTING .....	30
COMMISSIONING CHECK LIST .....	31
<b>ACCESSORIES .....</b>	<b>32</b>
<b>CONTACT INFORMATION .....</b>	<b>33</b>

# GENERAL INSTALLATION INSTRUCTIONS

## REGULATIONS

**This appliance must be installed in accordance with:**

- Current AS/NZS3000, AS/NZS3500 and NZS5261
- Rinnai Installation Instructions
- Local regulations and municipal building codes

**Installation, Service and Removal MUST BE by an Authorised Person only.**

## APPLICABLE MODELS

These Installation Instructions apply to the following Rinnai continuous flow water heater models:

REU-V1620WG	REU-V2630WG	REU-VM2630WC
REU-V1818WG	REU-V3237WG	REU-VM3237WC
REU-V2024WG	REU-VM2024WD	REU-V2632FFUG
REU-V2426WG	REU-VM2630WD	REU-VM2632FFUC
REU-K2430WG		REU-VM3237FFUC

## APPLIANCE LOCATION

### (External Models)

This appliance is designed for 'Outdoor' Installation only. As such, it must be located in an above ground open air situation with natural ventilation, without stagnant areas, where gas leakage and products of combustion are rapidly dispersed by wind and natural convection.

This appliance must be mounted on a vertical structure with the water and gas connections on the underside pointing downwards. For appliances installed on elevated structures or under floors specific requirements apply. Refer to NZS5261 for details.

This appliance must not be used as a domestic spa or swimming pool heater.

Location of the appliance flue terminal must be in accordance with NZS5261 Section 2.6.11, 2.6.12 and 2.6.13. Figure 3 is reproduced in the 'Horizontal Flue Terminal Clearances' section of these instructions. Note that NZS5261-2003 was current at the time of printing but may have been superseded. It is the installers' responsibility to ensure current requirements are met.

### (Internal Models)

This appliance is designed for 'Indoor' installation only. It may be installed 'Outdoors' in an enclosure if the requirements of NZS5261 are satisfied. An enclosure is defined as a compartment, enclosed area or partitioned off space primarily used for the installing of the appliance. If installed in an enclosure, either Internally or Externally, the location should be ventilated to allow gas to dissipate and provision must be made for the safe disposal of any leaking water to an exposed location.

This appliance must be mounted on a vertical structure with the water and gas connections on the underside pointing downwards. For appliances installed in roof spaces or elevated structures specific requirements apply. Refer to NZS5261 Section 1.6 for details.

This appliance must not be used as a domestic spa or swimming pool heater.

This appliance MUST be used with the Rinnai Infinity flueing system only. The use of a non Rinnai flueing system may result in a dangerous situation and violates regulations.

This appliance must be located so that the flue terminal exits the building at a suitable point. Figure 3 is reproduced under "MINIMUM CLEARANCES REQUIRED FOR FLUE TERMINALS (Extract from NZS5261-2003)" on page 22.



**NZS5261-2003 was current at the time of printing but may have been superseded. It is the installer's responsibility to ensure current requirements are met.**



**Flue Dip-Switch, if flue length exceeds 2m, dip-switch 1 of SW1 is to be switched to the 'OFF' position.**

# GENERAL INSTALLATION INSTRUCTIONS

## **(All Models)**

This appliance must be placed as close as practicable to the most frequently used hot water outlet or outlets to minimise the delay time for hot water delivery. For installations where the distance between the water heater and the outlets is considerable, a flow and return system can be used to minimize the waiting time for hot water delivery. Alternatively, multiple appliances can be strategically placed to serve outlets with minimal delay time. Contact Rinnai for further information.

An AC230V, 10 Amp, earthed power point must be provided adjacent to the appliance. For outdoor installations this power point must be weather proof. It must be clear of the gas and water connections to the appliance and also the flue exhaust and water pressure relief valve. The power cord of the appliance is 1.5 Metres long.

All appliances must be installed to ensure access can be gained without hazard or undue difficulty for inspection, repair, renewal or operational purposes. Sufficient clearances shall allow access to, and removal of, all serviceable components. Appliances should not be mounted higher than 3.5 metres above the ground or floor level unless the customer can arrange permanent and safe access or can provide another means of access, for example, by means of scissor or boom lifts.

## **PIPE SIZING**

See Table 1 page 21 for appliance gas consumption. If the gas pipe sizing is insufficient the customer will not get the full performance benefit. Gas pipe sizing must consider the gas input to this appliance as well as all the other gas appliances in the premises. The gas meter and regulator must be specified for this gas rate. An approved sizing chart such as the one in NZS5261 should be used.

Water pipe sizing and layout should be performed in accordance with AS/NZS3500. All hot water pipe-work should be insulated to optimise performance and energy efficiency.

## **WATER SUPPLY**

See Table 1, page 21 for applicable water pressures. Approved pressure limiting valves may be required if the 'Maximum' rated water supply pressures in Table 1 are exceeded. To achieve the rated flow, the 'Minimum' water supply pressures in Table 1 must be supplied. The water heaters will operate at lower pressures but will not achieve the rated flow. Contact Rinnai for 'gravity fed' or 'low pressure' installations.

Water chemistry and impurity limits are detailed under 'Warranty Conditions'. Most metropolitan water supplies fall within the requirements. If you are unsure about your local water quality, contact your water authority. If sludge or foreign matter is present in the water supply, a suitable filter or strainer should be incorporated in the water supply to the water heater.

## **HOT WATER DELIVERY TEMPERATURE**

Local regulations and or the requirements of AS/NZS 3500.4 must be considered regarding the temperature limitations of hot water supplied to areas used primarily for personal hygiene. The temperature of water to these areas may be limited to 55° C or less. To ensure these regulations and or requirements are met the system MUST be installed in accordance with the 'Water Heater and Controller Installation Configurations' section of these instructions.

## **MOUNTING THE APPLIANCE**

See Table 1, page 21 for individual appliance weights. The wall or structure on which the units are to be mounted must be capable of supporting these weights and the associated pipe-work.

# GENERAL INSTALLATION INSTRUCTIONS



If the appliance is to deliver water primarily for the purposes of personal hygiene in an early childhood centre, primary or secondary school, nursing home or a similar facility for the care of young, aged, sick or disabled persons as defined in AS/NZ3500.4 a Temperature Limiting Device (TLD), such as a Tempering Valve may be required even if the appliance is set to 55° C or less.

For these types of applications contact Rinnai.

## REQUIREMENTS FOR INFINITIES INSTALLED WITHOUT CONTROLLERS

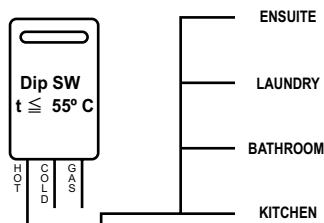

Diagram 1 - 55°C Appliance

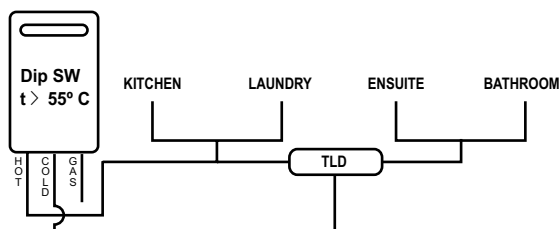

Diagram 2 - Not a 55°C Appliance

Note: TLD = Temperature Limiting Device

When the Infinity is set to deliver water at a temperature higher than 55° C, it will be necessary to fit a temperature limiting device for delivery to areas used primary for the purposes of personal hygiene. Refer Department of Building and Housing G12.

Ensure that suitable fixing screws or bolts are used to secure the units to the wall, in accordance with NZS5261 section 5. Wooden plugs shall not be used.

The top bracket has a keyhole slot so that the appliance can be positioned by hanging it on one screw, then the other screws can be secured.

## SERVICE CONNECTION POINTS

See Table 1 for individual appliance connection / fitting dimensions. Note that these dimensions are NOT an indication of the pipe sizes required.

An approved full flow isolation valve and disconnection union MUST be fitted to the cold water inlet. A non return valve is not required unless required by local regulations.

Isolation Valves must not be fitted directly to the appliance.

Purge gas and cold water supply lines to remove air and swarf before final connection of the appliance. Swarf in either the gas or water supplies may cause damage.

Model:	Gas Consumption MJ/h	Water Supply kPa		Weight kg	Fittings			Condensate
		Min.	Max.		Hot	Cold	Gas	
REU-V3237WG / REU-VM3237WC / REU-VM3237FFUC	250	200	1000	29	R ¾ (20mm)	R ¾ (20mm)	R ¾ (20mm)	
REU-V2630WG / REU-VM2630WC	199	190	1000	17	R ¾ (20mm)	R ¾ (20mm)	R ¾ (20mm)	
REU-VM2630WD	199	190	1000	17	R ¾ (20mm)	R ¾ (20mm)	R ¾ (20mm)	
REU-V2632FFUG / REU-VM2632FFUC	195	140	1000	21	R ¾ (20mm)	R ¾ (20mm)	R ¾ (20mm)	
REU-K2430WG	162	240	1000	27	R ¾ (20mm)	R ¾ (20mm)	R ¾ (20mm)	R ½ (15mm)
REU-V2426WG	188	180	1000	15	R ¾ (20mm)	R ¾ (20mm)	R ¾ (20mm)	
REU-V2024WG	160	160	1000	15	R ¾ (20mm)	R ¾ (20mm)	R ¾ (20mm)	
REU-VM2024WD	160	160	1000	15	R ¾ (20mm)	R ¾ (20mm)	R ¾ (20mm)	
REU-V1818WG	160	100	1000	15	R ½ (15mm)	R ½ (15mm)	R ¾ (20mm)	
REU-V1620WG	125	120	1000	15	R ½ (15mm)	R ½ (15mm)	R ¾ (20mm)	

Table 1.

# GENERAL INSTALLATION INSTRUCTIONS

## MINIMUM CLEARANCES REQUIRED FOR FLUE TERMINALS (Extract from NZS5261-2003)

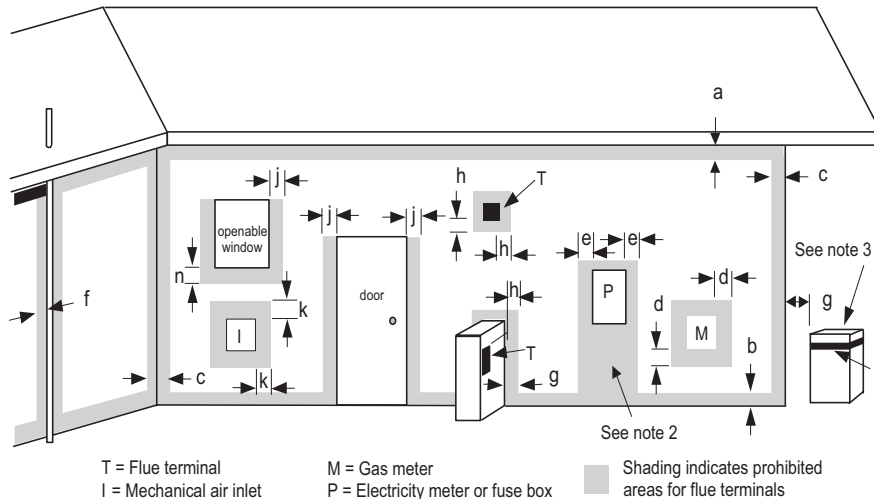

Ref .	Item	Minimum clearances (mm)	
			Fan assisted
a	Below eaves, balconies and other projections:		
	Gas appliances up to 50 MJ/h input		200
	Gas appliances over 50 MJ/h input		300
b	From the ground, above a balcony or other surface (see Note 6)		300
c	From a return wall or external corner (see Note 6)		300
d	From a gas meter (M) (see 2.5.4.9 for vent terminal location of regulator)		1000
e	From an electricity meter or fuse box (P)		500
f	From a drain pipe or soil pipe		75
g	Horizontally from any building structure (see Note 6) or obstruction facing a terminal		500
h	From any other flue terminal, cowl, or combustion air intake (see Note 6)*		300
j	Horizontally from an openable window, door, non-mechanical air inlet, or any other opening into a building with the exception of sub-floor ventilation:		
	Gas appliances up to 150 MJ/h input		300
	Gas appliances over 150 MJ/h input up to 200 MJ/h input		300
	Gas appliances over 200 MJ/h input		500
	All fan-assisted flue gas appliances, in the direction of discharge		1500
k	From a mechanical air inlet, including a spa blower		1000
n	Vertically below an openable window, non-mechanical air inlet, or any other opening into a building with the exception of sub-floor ventilation:		
	Space heaters up to 50 MJ/h input		150
	Other gas appliances up to 50 MJ/h input		500
	Gas appliances over 50 MJ/h input and up to 150 MJ/h input		1000
	Gas appliances over 150 MJ/h input		1500

### NOTE-

- (1) All distances are measured to the nearest part of the terminal.
- (2) Prohibited area below electricity meter or fuse box extends to ground level.
- (3) See Clause 2.6.12.3 for restrictions on a flue terminal under a covered area.
- (4) See Appendix G LPG Cylinder Locations, figure G2 and figure 32, for clearances required from a flue terminal to an LPG cylinder.  
A flue terminal is considered to be a source of ignition.
- (5) For gas appliances not addressed above, the design shall be certified by a suitably qualified engineer.
- (6) Some gas appliances may be suitable for closer installation; refer to the manufacturer's instructions.

in the 'Operation/Installation Manual' Most New Zealand water supplies will fall within these guidelines. If you are unsure of your water quality, contact your local water authority. If sludge or foreign matter is present in the water supply, a suitable filter should be incorporated in the cold water supply pipe. Note: Some Bore water may not be in accordance with the specifications and may contain undissolved gasses which should be removed.

\*Contact Rinnai for exemptions for the above clearances which may have been granted since printing of this document.

## MULTIPLE INSTALLATIONS OF EXTERNAL MODELS

Dimension 'h' above does not apply when multiple Rinnai external water heaters of the same model are installed on the same vertical face with flue terminals at the same height. Under these conditions, appliances can be installed next to each other as shown. The total gas consumption of all appliances applies when determining other clearances.

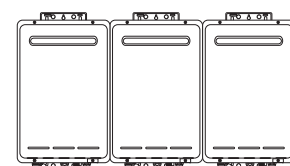



# GENERAL INSTALLATION INSTRUCTIONS

## APPLIANCE DIMENSIONS

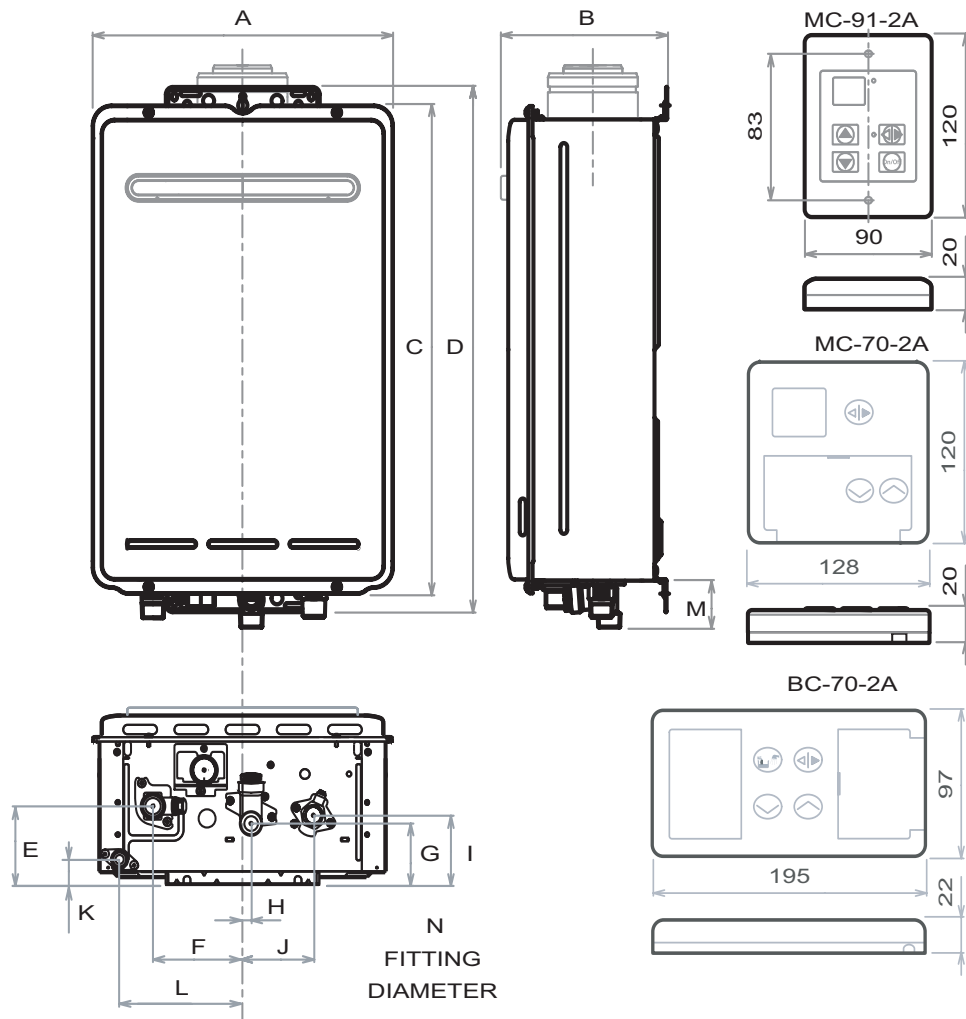

Dim'	Description	REU-V3237WG REU-VM3237WC	REU-V2630WG REU-VM2630WC	REU-VM2630WD REU-VM2024WD	REU-V2632FFUG REU-VM2632FFUC	REU-K2430WG	REU-V2426WG	REU-V2024WG REU-V1818WG	REU-V1620WG	REU-VM3237FFUC
A	Width	470	350	355.6	350	350	350	350	350	470
B	Depth	244	194	202	234.5 ~ 274.5	277	194	194	194	220
C	Height - Unit	600	530	503	600	600	530	530	530	600
D	Height - Including Brackets	644	571	571	641	644	571	571	571	620
E	Hot Water outlet (from wall)	115	87	87	91 ~ 131	164.5	87	87	87	112 ~ 149
F	Hot Water outlet (from centre)	61	105	105	110	100	105	105	105	61
G	Cold Water inlet (from wall)	99	68	68	70 ~ 110	83	68	68	68	94 ~ 135
H	Cold Water inlet (from centre)	52	10	10	27*	53	10	10	10	51
I	Gas Connection (from wall)	61	77	77	99 ~ 139	70.5	77	77	77	56 ~ 96.5
J	Gas Connection (from centre)	110	83	83	89	25	83	83	83	110
K	Condensate outlet (from wall)	-	-	-	-	33	-	-	-	-
L	Condensate outlet (from centre)	-	-	-	-	132	-	-	-	-
M	Gas: Length Gas Connection (from base)	41	40	40	41	51	40	40	40	-
	Cold: Length Cold Water inlet (from base)	51	50	50	51	62	50	50	50	-
	Hot: Length Hot Water outlet (from base)	42	42	42	42	41	42	42	39	-
	Condensate Connection Length (from base)	-	-	-	-	24	-	-	-	-
N	Gas: Fitting Diameter	20	20	20	20	20	20	20	20	20
	Cold: Fitting Diameter	20	20	20	20	20	20	20	15	20
	Hot: Fitting Diameter	20	20	20	20	20	20	20	15	20
	Condensate: Fitting Diameter	-	-	-	-	15	-	-	-	-

\* Please note that this measurement is to the left of the centre line.

# CONDENSATE DRAIN (REU-K2430WG ONLY)

The Efficiency REU-K2430WG water heater generates condensate continuously at a rate of up to 5 litres per hour as a by-product of a highly efficient gas burner system. This condensate must be drained via a pipe to a suitable point of discharge. Because the condensate is a by-product of gas combustion it is mildly acidic. For this reason copper tube and fittings **MUST NOT** be used as it will corrode. Instead, Rinnai recommend plastic pipes and fittings such as Unplasticised Polyvinyl Chloride (UPVC) or Polyethylene (PE) which is commonly used for irrigation piping.

## IMPORTANT CONSIDERATIONS FOR THE CONDENSATE DRAIN PIPE



The content of AS3500.4:2003 Section 5.12 'Temperature / Pressure Relief and Expansion Control Valve Drain Lines' has been used as a guide in preparing these considerations.

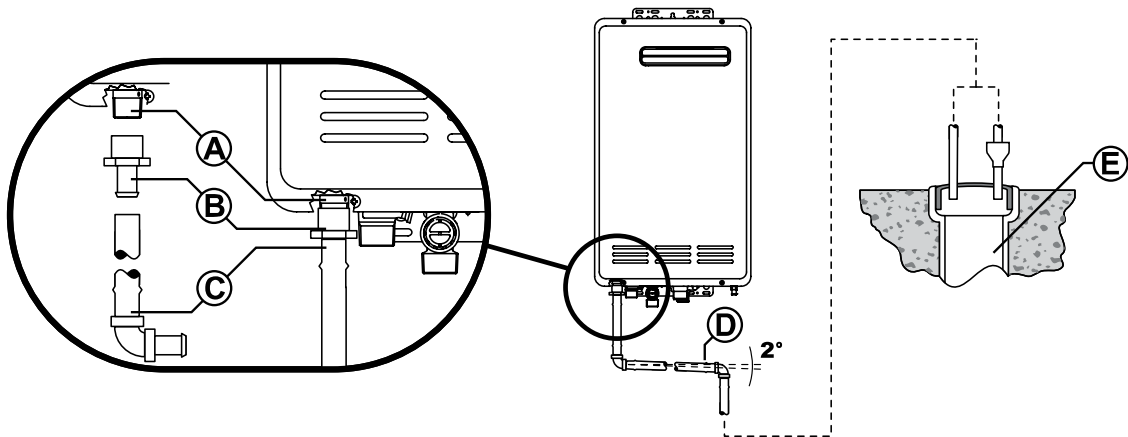

- (A) Water heater drain outlet connection, 1/2" (20mm) BSP male.
- (B) PE 1/2" BSP (20mm) female to barbed irrigation system connector (13 – 19mm) or equivalent plastic fitting.
- (C) Drain pipe and fittings to match item (B).
- (D) Continuous fall (of at least 2°) from water heater to discharge point. Lengths and bends in accordance with '**LENGTH AND CHANGES OF DIRECTION**' below.
- (E) Suitable points of discharge are deemed to be drains, sewers or pits. **DO NOT** discharge onto electrical connections, earth stakes, copper pipes, concrete paths or into a pond.

### LENGTH AND CHANGES OF DIRECTION

Maximum length and changes of direction greater than 45° should be as follows:

Lengths and changes of direction				
Max length (Metres)	9	8	7	6
Max changes of direction >45°	3	4	5	6

### INSTALLATION

- (a) The drain line **MUST NOT** discharge onto electrical connections, earth stakes, copper pipes, concrete paths or into a pond.
- (b) The point of discharge from each drain line shall be located so that the release of condensate does not cause a nuisance, is readily discernible and incurs no risk of damage to the building.

In view of (a) and (b), suitable points of discharge are deemed to be drains, sewers or pits.

- (c) There shall be no tap, valve or other restrictions in any line.
- (d) Each line shall fall continuously from the valve to the approved point of discharge.
- (e) Drain lines shall not discharge into a storage water heater safe tray.
- (f) The end of the condensate drain line shall be:
  - (i) not lower than 200 mm or higher than 300 mm above an unpaved surface; or
  - (ii) not lower than 75 mm or higher than 300 mm above a gravel pit, not less than 100 mm in diameter in a paved surface.

# CONDENSATE DRAIN (REU-K2430WG ONLY)

- (g) Where discharging over a tundish or gully trap, drain lines shall have an air gap of a size at least twice the diameter of the drain line.

## INTERCONNECTION OF CONDENSATE DRAIN LINES

Condensate drain lines from multiple water heaters may be joined together provided they conform with the '**INSTALLATION**' requirements on page 25.

## COMMON STACK DISCHARGE

Where individual water heaters are installed in a multistorey building, the condensate drain lines may discharge into a common stack, subject to the following:

- (a) The discharge from the common stack is to a tundish, having a discharge line, that is not less than the size of the common stack, directly connected to a fixture trap, and installed in connection with any adjacent soil or waste stack.
- (b) The discharge point of the common stack is such that any discharge is readily visible and not cause any nuisance.
- (c) The common stack is vented by extending the pipe upwards, above the roof level.

## TUNDISH DRAIN LINES

The drain line from any tundish shall be not less than DN 20 or less than one size larger than that of the largest drain line discharging into the tundish. Tundish drain lines shall comply with the '**INSTALLATION**' requirements on page 25.

## AREAS SUBJECT TO FREEZING

In areas where water pipes are prone to freezing, the drain pipe from any valve shall be insulated and not exceed 300 mm in length. It shall discharge into a tundish through an air gap of not less than 75 mm and not more than 150 mm measured from the outlet of the drain pipe to the rim of the tundish.

# WATER CONTROLLER INSTALLATION

## RINNAI WATER CONTROLLERS

Water Controllers are available as an optional extra. Universal, Deluxe, and Wireless Controllers can be used together and will function as described in the Operation Section of this manual. Please refer to the table on page 6 to confirm the maximum number and combination of controllers that can be fitted. This section refers to wired controllers, for details on installation of Wireless Controllers, please refer to separate instructions.



**Other manufacturers' controllers are NOT compatible with this appliance.**

## POSITIONING OF WATER CONTROLLERS

Controllers must be installed in shaded and clean locations. They should be fitted out of reach of children (suggested height from floor to be at least 1500mm). Controllers are water resistant, however, durability is improved when positioned outside the shower recess or at least 400mm above the highest part of a sink, basin or bath.



### DO NOT INSTALL CONTROLLERS:

**Near a heat source, such as a cook top, stove or oven. Heat, steam, smoke and hot oil may cause damage.**

**In direct sunlight.**

**Outdoors unless protection from dust ingress and sunlight are provided.**

**Against a metal wall unless the wall is earthed in accordance with AS3000.**

## WATER CONTROLLER CABLES

Water controls operate at extra low voltage (12 Volts DC) which is supplied from the water heater. Controllers come supplied with 15 m of electrical cable. The appliance end of the controller cables are fitted with spade terminals. Extension cabling is available from Rinnai.



**Alternatively, a two core sheathed (double insulated) flex with minimum cross-sectional area of 0.5 mm<sup>2</sup> may be used. Maximum individual cable runs not to exceed 50 m.**

## FITTING THE 'UNIVERSAL' WATER CONTROL (MC-91-2A)

1. Determine the most suitable position for the water controller.
2. Drill 3 holes as shown in Fig. 1, two for the securing screws and one to provide cable access.
3. When running cable through the access hole ensure the connector end of the cable is located nearest to the controller. (Fig.2)
4. Carefully remove face plate from water controller, using a screw driver. (Fig. 3)
5. Connect the cable to the water controller.
6. Fix the controller to the wall using the appropriate fixings as shown in Fig. 4.
7. Remove protective plastic film from the controller face as shown in Fig. 4 and replace face plate.

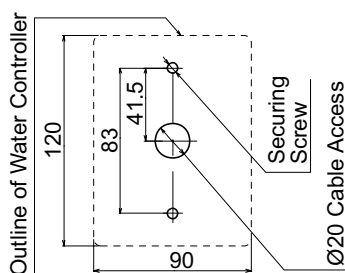

Fig. 1

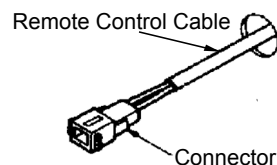

Fig. 2

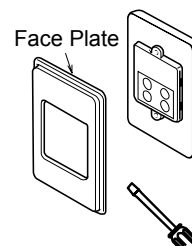

Fig. 3

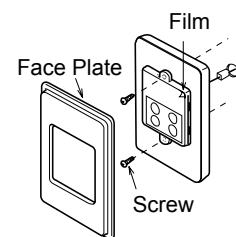

Fig. 4

# WATER CONTROLLER INSTALLATION

## OPTIONAL PROGRAMMING FOR THE 'UNIVERSAL' WATER CONTROLLER (MC-91-2A)



### 1 Are 4 controllers connected ?

**IF NO:** (You have 3 controllers or fewer), go to Question 2.

**IF YES:** You will need to activate the fourth controller as follows:

**STEP 1:** For the controller in the KITCHEN only, press and hold the 'Transfer' and 'On / Off' buttons simultaneously (see Fig. 5) until a 'beep' is heard (approximately 5 seconds).

**STEP 2:** Check that the display on ALL FOUR controllers is lit and displaying a temperature when 'switched on'. If any ONE of the controller displays two dashes (see Fig. 6) repeat STEP 1.

This completes the activation procedure for the fourth controller, you may ignore Question 2.

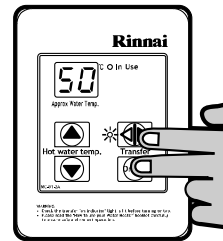

Fig. 5



Fig. 6



### 2 Is the water heater marked to state it delivers water not exceeding 50°C ?

**IF YES:** No further action required.

**IF NO:** You will need to program the kitchen controller to enable selection of temperatures higher than 50°C.

**STEP 1:** For the controller in the KITCHEN only, press and hold the 'Transfer' and 'On / Off' buttons simultaneously (Fig. 7) until a 'beep' is heard (approximately 5 seconds).

**STEP 2:** When the controller fitted in the KITCHEN is switched On, it should be possible to select temperatures higher than 50°C. If not, repeat STEP 1.

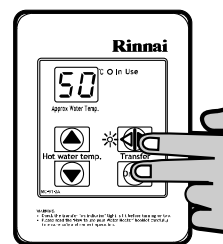

Fig. 7



**If the kitchen controller is replaced, repeat STEP 1 above for the replacement controller.**

**If the kitchen controller is swapped with another controller (for example, the controller fitted in a bathroom), repeat STEP 1 for the controller moved from the kitchen to the bathroom. Then perform STEP 1 for the controller moved from bathroom to the kitchen.**

## FITTING THE 'DELUXE KITCHEN' WATER CONTROLLER (MC-70-2A/MC-100V)

1. Determine the most suitable position for the water controller.
2. Using the wall mounting bracket as a template mark and drill 3 holes. Locate the cable access hole as shown in Fig. 1.
3. Fix the mounting bracket to the wall using the appropriate fixings.
4. Run the control cable through the hole in the wall.

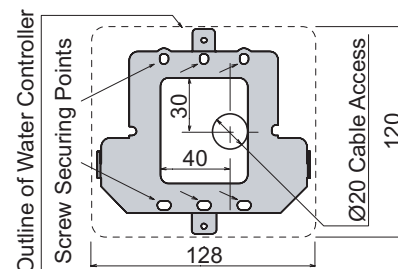

Fig.1

# WATER CONTROLLER INSTALLATION

1. Carefully remove face plate from water controller, using a screw driver. (Fig. 2)
2. Connect the cable to the kitchen remote control as shown in Fig 3. At this point cables from other controllers (if fitted) may also be connected to the kitchen remote terminals eliminating the need to have multiple cable runs directly to the hot water heater, controllers are not polarity sensitive.



**If the cable cannot be run in the wall cavity, remove the plastic 'knockout' lugs as shown in Fig. 3.**

3. Fasten the controller to the wall as shown in Fig. 4.
4. Remove the protective plastic film from the controller face as shown in Fig. 5.
5. Replace the face plate and close the flip panel.

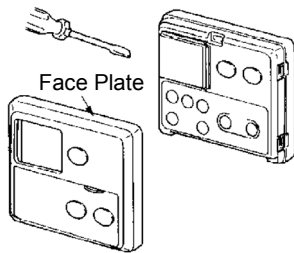

Fig. 2

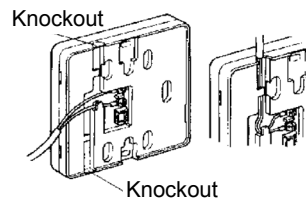

Fig. 3

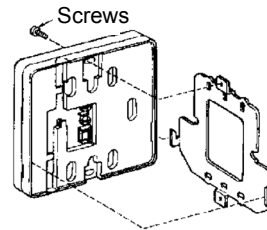

Fig. 4

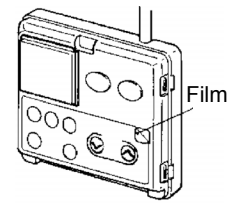

Fig. 5

## FITTING THE 'DELUXE BATHROOM' WATER CONTROLLER (BC-70-2A/BC-100V)

1. Determine the most suitable position for the water controller.
2. Drill 3 holes in the wall, as shown to the right in Fig. 1, one for the cable and two for the securing screws. Drill holes to ensure controller position will be level when installed.
3. When running cable through the access hole ensure the connector end of the cable is located nearest to the controller. (Fig. 2)
4. Carefully remove the face plate from the water controller, using a screw driver. (Fig. 3)
5. Connect the cable to the bathroom water controller.
6. Fix the bathroom controller to the wall using the appropriate fixings as shown in Fig. 4.
7. Remove the protective plastic film from the controller face as shown in Fig. 4.
8. Replace the face plate and close the flip panel.

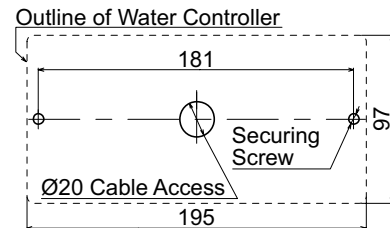

Fig. 1

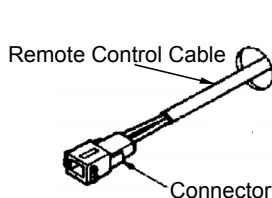

Fig. 2

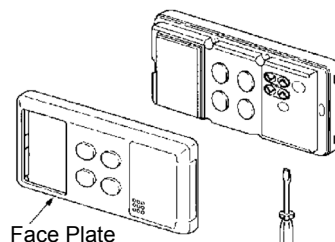

Fig. 3

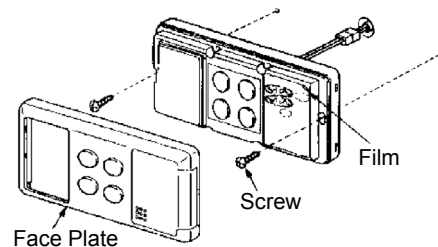

Fig. 4

# WATER CONTROLLER INSTALLATION

## CONNECTING COMMUNICATION CABLES TO THE WATER HEATER

Communication cables connect the water heater to water controllers and operate at an extra low voltage (12 Volts DC) which is supplied from the water heater. Communication cables are supplied with the water controllers (15m) and are fitted with spade terminals for connection to water heater. Up to two cables can be connected directly to the cable connector at the water heater. Extension cables are available from Rinnai. Alternatively, two core sheathed (double insulated) flex with minimum cross sectional area of 0.5mm<sup>2</sup> may be used. Cable lengths must not exceed 20 metres.



**DO NOT attempt to connect cables to the cable connector at the water heater unless the electric power to the water heater is switched 'off' otherwise damage to electrical components may occur.**

### To connect up to two cables to the cable connector

1. Isolate the electric power supply by switching the power point off and removing the power plug of the water heater from the electric power socket.
2. Remove the retaining screw (A) of the cable connector at the base of the appliance.
3. Swing the cable connector door open and thread the cable through the weather seal of the cable access hole (B) in the direction shown allowing sufficient cable length so that the sheath of the cable can be secured with cable clamp (C) supplied with the transceiver.
4. Loosen screw terminals (D) and (E) and connect the cable spade connectors to these terminals and re-tighten. Polarity is not important, either wire colour can be connected to either terminal.
5. Return the cable connector to the original position taking care not to damage cable wires in the process and replace the retaining screw (A).

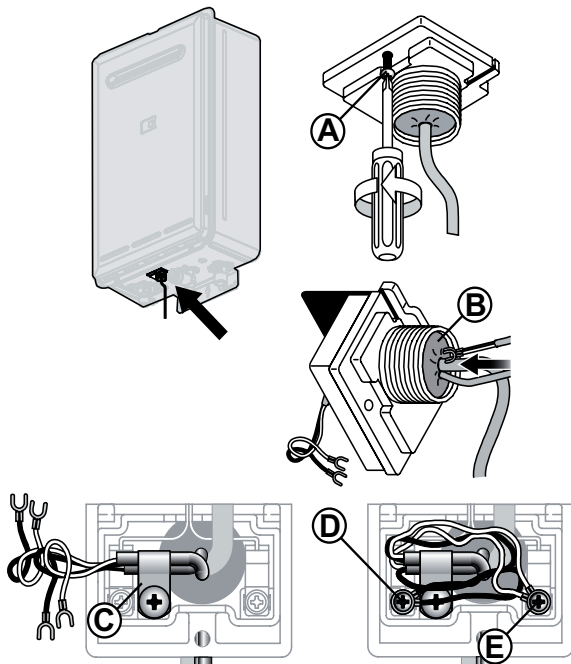

The cable connector for water heater models:  
INFINITY XR26, XR24, XR20, XR18, XR16 and HD200

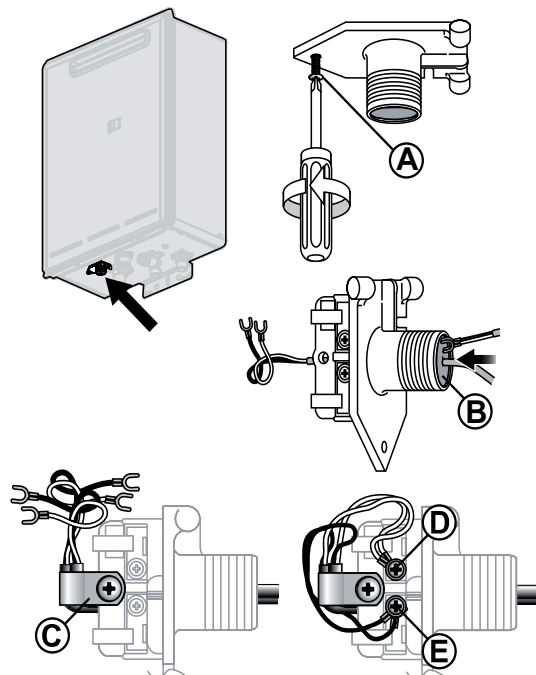

The cable connector for water heater models:  
INFINITY XR32, XR26i, HD250, HD250i, HD200i, and Efficiency24

### Connecting Three or Four Controllers

Repeat steps 1, 2 and 3 above.

To connect three or four cables, separate all the cables to be fitted into pairs. Cut off the existing spade connectors from each pair and re-terminate each pair into a new spade connector (available from your local electrical component retailer) (F) so that there are only two sets of spade connectors (4 spade connectors in total) to be terminated.

Repeat steps 4 and 5 above.

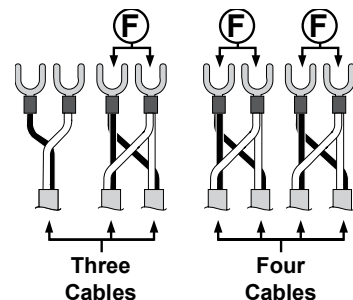

# COMMISSIONING

## TESTING

1. Before final connection of the water heater purge gas, hot water and cold water supply lines. Swarf in either the gas or water supplies may cause damage.
2. Turn on gas and cold water supplies.
3. Test for water leaks and gas escapes near the unit.
4. Isolate gas supply. Remove test point screw located on the gas inlet connection and attach pressure gauge.
5. Turn the power 'on' at the power point socket and turn on gas.
6. If water controllers are fitted, turn ensure they are controller 'ON', select the maximum delivery temperature and open ALL available hot water taps including the shower. If remote controllers are not fitted, simply open all available hot water taps. (CAUTION: Ensure building occupants do not have access to hot water outlets during this procedure.)
7. Operate ALL other gas appliances at their maximum gas rate, in accordance with manufacturers instructions.
8. With all gas appliances in operation at maximum gas rate, the pressure should read between 1.0 - 3.5 kPa on Natural Gas. On LPG the pressure should be 2.75 - 3.5 kPa. If the pressure is lower, the gas supply is inadequate and the appliance will not operate to specification. It is the Installers responsibility to check the gas meter, service regulator and pipe work for correct operation/sizing and rectify as required. Note that the gas regulator on the appliance is electronically controlled and factory pre-set. Under normal circumstances it DOES NOT need adjustment during installation.
9. Close hot water taps including the shower.
10. Inspect and clean the strainer located on the cold water inlet connection. This procedure may need to be repeated to ensure the strainer remains clear, especially on new installations.
11. If water controllers are fitted, it is necessary to test their operation through the complete range of functions (refer to the Operation sections of this manual).
12. Confirm the hot water delivery temperature(s) using a thermometer. If controllers are fitted, ensure temperatures exceeding 55° C cannot be selected on bathroom or ensuite controllers.
13. After testing is completed, explain to the householder the functions and operation of the water heater and temperature controllers (if fitted). Ensure the 'Customer Record' on page 17 of this manual is filled in and that the booklet is handed to the customer.

## GAS PRESSURE SETTING

The regulator is electronically controlled and factory pre-set. Under normal circumstances it does not require adjustment during installation.

Make adjustments only if the unit is not operating correctly and all other possible causes for incorrect operation have been eliminated.

Instructions for Gas Pressure Setting are to be found in the instruction pocket located inside the appliance front cover.

## COMMISSIONING CHECK LIST

A commissioning check list is provided to enable the installer to step through the correct commissioning procedure when installing a Rinnai continuous flow water heater.

The check list can also assist the installer to identify potential installation errors that may prevent the appliance from operating correctly.

For your convenience a copy of the commissioning check list has been provided on the following page.



## COMMISSIONING CHECK LIST

### Attention Installer - have you checked!

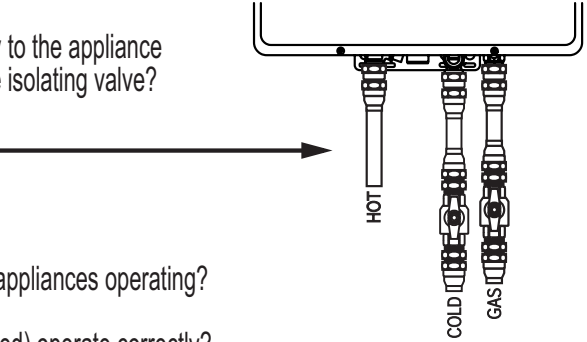
- Gas supply pipe is purged of foreign matter before connection.
- For Hot and Cold cross connections i.e. Capped breaches / Shower Mixers, taps closed and reversed 'Flick Mixer' connections?
- That isolating valves are not connected directly to the appliance and there is a means of disconnection after the isolating valve?
- That plumbing connections are correct? 
- Have you turned on the power?
- Is appliance inlet gas pressure correct with all appliances operating?
- Do the Kitchen and Bathroom Controllers (if fitted) operate correctly?
- Tempering Valve (if fitted) - Is it an RMC Heat Guard 15/20HP or equivalent for continuous flow water heaters?
- Have you checked water temperature at all outlets?
- Have you cleaned cold water inlet filter?
- Have you shown the customer how to operate the Temperature Controllers? (If fitted)
- Have you explained to the Customer the Benefits of Controllers (if not fitted) and that they can be added later?
- Have you explained to the customer the minimum flow rate required to operate the unit?
- Have you checked the flue clearances and installation and as per NZS5261
- Resistance across controller terminal is greater than 100k ohm.

#### **For Efficiency models.**

#### **For Internal (FFU) models where flue length exceeds 2 metres.**

- Have you connected a condensate drain pipe in accordance with the flueing and installation Instructions.

#### **For Internal (FFU) models only**

- Have you used only Rinnai FFU flueing components?
- If flue length exceeds 2m, dip-switch 1 of SW1 is to be switched to the 'OFF' position as shown.

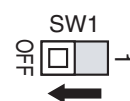

#### **PLEASE NOTE:**

*That warranty may be voided and a service charge may be incurred as a result of Rinnai staff attending to a problem related to installation.*

# ACCESSORIES

## **Recess Box:**

When installing an Rinnai continuous flow hot water heater in a new home or renovation, it is a great idea to allow for a recess box to be included at the construction stage. These boxes allow you to literally recess the appliance into the cavity of the wall saving precious space. In addition they virtually hide your hot water system altogether.

All boxes and covers are suitable for painting to blend in with the exterior of your home.

## **Pipe Cover:**

Where a recess box is not used, pipe covers are recommended as the finishing touch to an Rinnai continuous flow hot water heater installation. Basically the covers are designed to hide the plumbing pipework and valves. These are particularly popular in installations where the unit is permanently visible to the occupants of the house. The cover can be easily attached to the appliance and two pipe covers can be joined together for longer pipework if necessary.

## **Security Bracket:**

Prevent theft by securing your Rinnai continuous flow hot water heater with our custom security bracket, easily installed it covers the lower mounting bracket of the appliance to create a tamper proof installation.

## **Flue Diverters**

Designed to redirect flue products when the water heater is installed on a balcony, patio etc. this product is available for selected models only.

**Contact Rinnai for further information about our accessory range and model suitability details.**

# Rinnai

## Customer Contacts

Consumer Enquiries: 0800 746624 (0800 RINNAI)

Installer Enquiries: 0800 86746624 (0800 TORINNAI)

## **Rinnai New Zealand Limited**

691 Mt. Albert Road,  
PO Box 24068 Royal Oak, Auckland  
Email: [info@rinnai.co.nz](mailto:info@rinnai.co.nz)  
[www.rinnai.co.nz](http://www.rinnai.co.nz)



060 00012 33685 6

U283-932x01(00)  
2007.02