

GENERAL INSTALLATION INFORMATION REU-V1616WF

You must install this appliance in accordance with these Instructions and all regulatory requirements which exist in your area. Applicable publications may include:

- AG601/AS5601 - Gas Installations
- AS/NZ3500 - National Plumbing and Drainage
- AS/NZ3000 - Wiring Rules
- Building Codes of Australia

THIS APPLIANCE IS DESIGNED FOR INDOOR INSTALLATION. IT MAY BE INSTALLED IN A SUITABLE OUTDOOR ENCLOSURE IF THE REQUIREMENTS OF AS5601/AG601 SECTION 5 ARE SATISFIED.

THIS APPLIANCE MUST BE MOUNTED ON A VERTICAL WALL OR STRUCTURE WITH THE WATER AND GAS CONNECTIONS ON THE UNDERSIDE POINTING TOWARDS THE GROUND.

THIS APPLIANCE MUST BE INSTALLED WITH THE RINNAI INFINITY FE FLUEING SYSTEM. NON RINNAI FLUEING SYSTEMS MUST NOT BE USED.

THIS APPLIANCE MUST NOT BE USED AS A DOMESTIC SPA OR SWIMMING POOL HEATER.

APPLIANCE LOCATION

The appliance should be placed as close as practicable to the most frequently used hot water outlet point or points to minimise the delay time for hot water delivery. For installations where the distance between the unit and hot water outlet points is considerable, the appliance can be fitted in a 'flow and return system' to minimise the waiting time for hot water delivery. Alternatively, additional appliances can be strategically placed to service outlet points with minimal delay time. Contact Rinnai Australia for further information.

This is not a room-sealed appliance, it **MUST** be installed to meet the requirements of AS5601/AG601 Clause 5.12.5; **DO NOT** install in:

- (a) Bedroom
- (b) Bathroom
- (c) Toilet; or
- (d) Combined living / Sleeping room.

The appliance must be located so that the flue terminal exits the building at a suitable point. The maximum length of the flue is 9 metres with a maximum of three 90° bends. Both a horizontal (wall) or vertical (roof) terminal are available. For detailed information regarding the Flue refer to the 'Flue Installation Instructions for Infinity FE series Internal Water Heaters' supplied with the FE series flue terminal or contact Rinnai for further details.

The appliance must be in an accessible location. Sufficient clearances shall allow access to, and removal of, all serviceable components. AS5601/AG601 clause 5.3.12 conveys the appliance should not be mounted higher than 3.5 metres from the ground or floor level unless the customer can arrange permanent and safe access or can arrange another means of access, for example, by means of scissor or boom lifts. Additional and or different requirements may exist in your area.

AC 240V, 10A earthed power point must be provided adjacent to the appliance. It must be clear of the gas and water connections to the appliance, flue and water pressure relief valve. The power cord of the appliance is 1500 mm long.

If a horizontal (wall) terminal is used, the location must be in accordance with the clearances shown in Figure 5.3 of AG601/AS5601 which is reproduced right side. Ensure that the flue terminal cannot be touched (particularly by children). The appliance must be clear of obstructions and shrubbery.

If a vertical (roof) terminal is used, the requirements of AG601/AS5601 apply. Clearances must be in accordance with the diagram shown in Fig.1 page 2.

Note: It is the installer's responsibility that the current requirements of AS5601/AG601 are met.

PIPE SIZING

This appliance has a maximum consumption of 125 MJ/h of gas. If the gas pipe sizing is insufficient the customer will not get the full performance benefit. Gas pipe sizing must consider the gas input to this appliance as well as all the other gas appliances in the premises.

The gas meter and regulator must be adequate. An approved sizing chart such as the one in AS5601/AG601 should be used.

Water pipe sizing and layout should be performed in accordance with AS/NZ3500. All hot water pipe work should be insulated to optimise performance and energy efficiency.

This appliance has a fan assisted flue system.

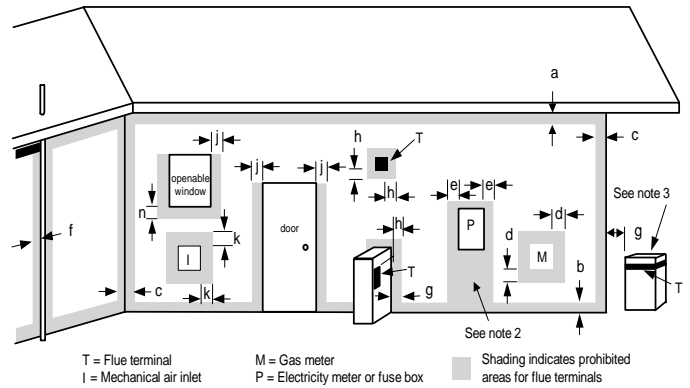

Ref.	Item	Min. clearances (mm)
		Fan assisted
a	Below eaves, balconies and other projections:	
	Appliances up to 50 MJ/h input	200
	Appliances over 50 MJ/h input	300
b	From the ground, above a balcony or other surface †	300
c	From a return wall or external corner †	300
d	From a gas meter (M) (see 4.7.11 for vent terminal location of regulator)	1000
e	From an electricity meter or fuse box (P)	500
f	From a drain pipe or soil pipe	75
g	Horizontally from any building structure = or obstruction facing a terminal	500
h	From any other flue terminal, cowl, or combustion air intake †*	300
j	Horizontally from an openable window, door, non-mechanical air inlet, or any other opening into a building with the exception of sub-floor ventilation:	
	Appliances up to 150 MJ/h input	300
	Appliances over 150 MJ/h input up to 200 MJ/h input	300
	Appliances over 200 MJ/h input	500
	All fan-assisted flue appliances, in the direction of discharge	1500
k	From a mechanical air inlet, including a spa blower	1000
n	Vertically below an openable window, non-mechanical air inlet, or any other opening into a building with the exception of sub-floor ventilation:	
	Space heaters up to 50 MJ/h input	150
	Other appliances up to 50 MJ/h input	500
	Appliances over 50 MJ/h input and up to 150 MJ/h input	1000
	Appliances over 150 MJ/h input	1500

† - unless appliance is approved for closer installation

Fig 5.3

NOTES:

- 1 All distances are measured to the nearest part of the terminal.
- 2 Prohibited area below electricity meter or fuse box extends to ground level.
- 3 See Clause 5.13.6.6 for restrictions on a flue terminal under a covered area.
- 4 See Appendix J, Figures J2(a) and J3(a), for clearances required from a flue terminal to an LP Gas cylinder. A flue terminal is considered to be a source of ignition.
- 5 For appliances not addressed above, approval shall be obtained from the Authority.

- * Contact Rinnai for exemptions for the above clearances which may have been granted since printing of this document.

VENTILATION REQUIREMENTS

This section contains extracts from AS5601/AG601, current at the time of printing.

It is the responsibility of the installer to ensure that current requirements are met.

The information in this section is based on and **MUST** be read in conjunction with AS5601/AG601.

AIR REQUIREMENTS

Where the total input of the appliance exceeds 3 MJ/h for each cubic metre of the room or enclosure volume, the area shall be ventilated by one of the following methods.

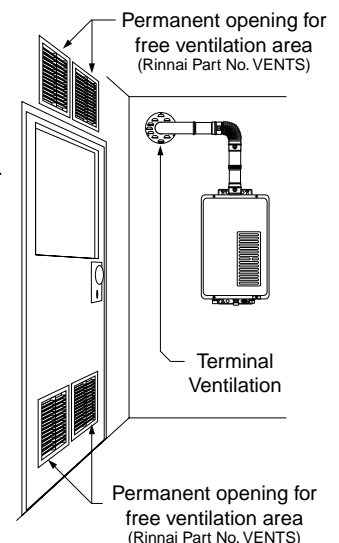

The REU-V1616WF is rated at 125MJ and has a minimum room area of 41.6m³ (125MJ / 3 = 41.6m³).
Approximately 4m L x 4.2m W x 2.4m H

If the room or enclosure is greater than 41.6m³ the required air may be provided by adventitious openings, i.e. gaps around doors, windows, etc.

Additional ventilation MUST consist of two permanent openings located to ensure the distance between the top of the upper opening and the ceiling of the room or enclosure, and the distance between the bottom of the lower opening and the floor of the room or enclosure does not exceed 5% of the height of the room or enclosure. The minimum vertical dimension of any free ventilation opening shall be 6 mm.

APPLIANCE IN A ROOM OR ENCLOSURE, OTHER THAN A PLANT ROOM WITH NATURAL VENTILATION DIRECT FROM OUTSIDE

The minimum free ventilation area provided by each opening shall be calculated using the formula: $A = 3 \times T$ where -
A = the minimum free ventilation area (cm²)
T = the total gas consumption of all appliances (MJ/h)

REU-V1616WF: $A = 3 \times 125\text{MJ/h}$

The free area Ventilation required is 375cm² Top, and 375cm² Bottom.

Four Rinnai Vents (Part No. VENTS) installed 2 top and 2 bottom will meet the requirements.

NATURAL VENTILATION VIA AN ADJACENT ROOM

The minimum free ventilation area provided by each opening shall be:
 $A = 6 \times T$

REU-V1616WF: $A = 6 \times 125\text{MJ/h}$

The free area Ventilation required is 750cm² Top, and 750cm² Bottom.

Six Rinnai Vents (Part No. VENTS) installed 3 top and 3 bottom will meet the requirements.

These requirements shall apply to all subsequent rooms until a room is ventilated to outside, in accordance with the requirements of natural ventilation direct from outside.

APPLIANCE IN A PLANT ROOM WITH NATURAL VENTILATION DIRECT FROM THE OUTSIDE

The minimum free ventilation area provided by each opening shall be:
 $A = 1.5 \times T$

REU-V1616WF: $A = 1.5 \times 125\text{MJ/h}$

The free area Ventilation required is 187.5cm² Top, and 187.5cm² Bottom.

Two Rinnai Vents (Part No. VENTS) installed 1 top and 1 bottom will meet the requirements.

Wherever possible more than one wall should be used to provide the ventilation. This allows a flow of air across the room and helps prevent excessive temperatures in the plant room.

APPLIANCE IN A PLANT ROOM WITH NATURAL VENTILATION VIA AN ADJACENT ROOM

The minimum free ventilation area provided by each opening shall be:
 $A = 3 \times T$

REU-V1616WF: $A = 3 \times 125\text{MJ/h}$

The free area Ventilation required is 375cm² Top, and 375cm² Bottom.

Four Rinnai Vents (Part No. VENTS) installed 2 top and 2 bottom will meet the requirements.

The adjacent room shall be ventilated directly to outside in accordance with the requirements of natural ventilation direct from outside.

APPLIANCE IN A RESIDENTIAL GARAGE

The minimum free ventilation area provided by each opening shall be:
 $A = 3 \times T$

REU-V1616WF: $A = 3 \times 125\text{MJ/h}$

The free area Ventilation required is 375cm² Top, and 375cm² Bottom.

Four Rinnai Vents (Part No. VENTS) installed 2 top and 2 bottom will meet the requirements.

The term 'directly to outside' means any one of the following options, provided that the ventilation path is unobstructed by building material or insulation:

- Directly through an outside wall (preferred option).
- Through to an outside wall but offset.
- Into a cavity ventilated to outside
- Into an under floor space ventilated to outside.
- Into a roof space ventilated to outside.

The two openings may be combined provided that the top and bottom of the opening reaches the limits set by this Clause

Enclosure ventilation for Caravans see: Clause 6.2.7

Enclosure ventilation for Marine Craft see: Clause 6.3.

Use combinations of fixed and adjustable flue lengths to position the installation, as flue components can NOT be cut to size.

The total flue length should not exceed 9m and the number of 90° bends should not exceed 3.

Note: The through wall terminal is equivalent to a 1m length and counts as one 90° bend, this factor must be taken into account when sizing an installation.

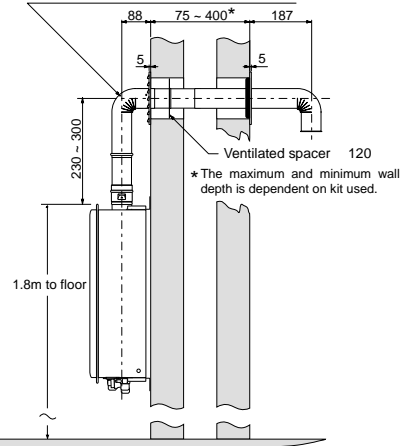

Install the Rinnai Infinity FE Flueing system in accordance with the Instructions supplied with the flue terminal. Non Rinnai flueing systems must not be used.

Where the water supply pressure exceeds 1000 kPa, an approved pressure limiting valve is required at the inlet of the appliance. To achieve the rated flow a minimum water supply pressure of 90 kPa is required at the appliance inlet. The unit will operate at lower supply pressures, but the rated flow will not be achieved. Contact Rinnai for 'gravity fed' or 'low pressure' hot water installations.

The water quality should be in accordance with the guidelines contained in the 'How to use your Water Heater' booklet. Most Australian Metropolitan water supplies will fall within these guidelines. If you are unsure of your water quality, contact your local water authority. If sludge or foreign matter is present in the water supply, a suitable filter should be incorporated in the cold water supply pipe.

Local regulations and / or the requirements of AS/NZ3500.4 must be considered regarding the temperature limitations of hot water supplied to areas used primarily for personal hygiene.

The temperature of water to these areas may be limited to 50° C or less. To ensure these regulations and / or requirements are met the system MUST be installed in accordance with the 'Water Heater and Controller Installation Configurations' Section of this document.

MOUNTING THE APPLIANCE

The appliance weighs 16 kg and the wall or structure on which it is to be mounted must be capable of supporting the weight of the appliance and associated pipe work. Ensure that suitable fixing screws or bolts are used to secure the appliance to the wall. The bracket and fixing hole locations are detailed in the WATER HEATER DIMENSIONS section.

The top bracket has a keyhole slot so that the appliance can be positioned by hanging it on one screw, then the other screws can be secured.

SERVICE CONNECTION POINTS

The cold water inlet and hot water outlet connections are R 1/2 (15mm), the gas connection is R 3/4 (20mm). This is NOT an indication of the pipe sizes required.

An Approved full flow isolation valve and disconnection union MUST be fitted to the cold water inlet. A non return valve is not required unless dictated by local regulations.

An Approved full flow isolation valve and disconnection union MUST be fitted to the gas inlet.

Isolation Valves must not be fitted directly to the appliance.

It may be necessary to fit a temperature limiting device for deliver to areas used primarily for the purposes of personal hygiene. Refer to the 'Water Heater and Controllers Installation Configurations' Section of this document.

Purge gas and cold water supply lines to remove air and swarf before final connection of the appliance. Swarf in either the gas or water supplies may cause damage.

PIPE COVER

The pipework underneath the appliance can be covered using a custom made Rinnai pipe cover. Contact Rinnai for further details.

REMOTE CONTROLLERS

Remote Controllers are an optional extra. Standard controls allow temperature selection only. For detailed information regarding controller operation refer to the 'How to use your water heater' booklet supplied with the appliance. Other manufacturers' controllers are NOT compatible with this appliance.

STANDARD CONTROLLER (MODEL MC-91-1A)

Up to 3 Standard Controllers can be fitted to the appliance. They are normally installed in the areas where the majority of hot water is used, for example, the kitchen, bathroom, ensuite and laundry.

POSITIONING OF CONTROLLERS

Controllers must be installed in shaded and clean locations. They should be fitted out of reach of children (suggested height from floor at least 1500mm). Controllers are water resistant, however, durability is improved when positioned outside the shower recess or at least 400mm above the highest part of a sink, basin or bath.

DO NOT INSTALL THE CONTROLLERS:

- Near a heat source, such as a cook top, stove or oven
- Heat, steam, smoke and hot oil any cause damage
- In direct sunlight
- Outdoors unless an enclosure is provided which protects the controller against sunlight and dust ingress
- Against a metal wall unless the wall is earthed in accordance with AS/NZ3000

REMOTE CONTROL CABLES

Remote controls operate at extra low voltage (12 Volts DC) which is supplied from the appliance. Controllers are supplied with 15 m of electrical cable. The cable wires for connection to the appliance are fitted with spade terminals.

Extension cables are available from Rinnai. Alternatively, a two core sheathed (double insulated) flex with minimum cross-sectional area of 0.5 mm² can be used. Maximum cable length is 50 m.

For connection refer to the "CONNECTING REMOTE CONTROL CABLES" section.

FITTING THE 'STANDARD' REMOTE CONTROLS (MC-91-1A)

1. Determine the most suitable position for the Remote Control.

2. Drill 3 holes in the wall, as shown in fig 1, one for the cable and two for the securing screws. Ensure holes are drilled. Fit wall plugs if required.

3. Run the cable through the hole in the wall, ensuring that the end fitted with the connector is near the controller. (fig 3)

4. Remove the face plate from the Remote Control, using a screw driver. (fig 2)

5. Connect the cable to the remote controller.

6. Fix the remote controller to the wall and fasten with phillips head screws as shown in fig 4.

7. Remove the protective plastic film from the controller face as shown in fig 4.

8. Replace the face plate.

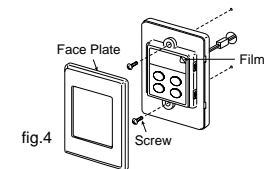
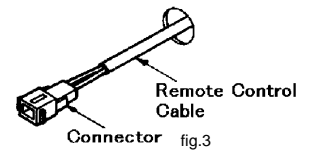
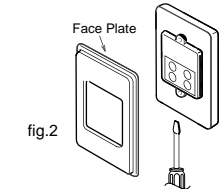
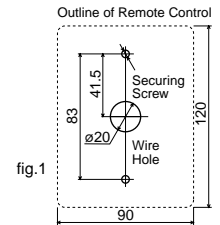

Note: For details on how to program the MC-91-1A remote control see Appendix 1. MC-91-1A CONTROLLER PROGRAMMING.

WATER HEATER & CONTROLLER INSTALLATION CONFIGURATIONS

If the front cover of the appliance contains the following text, install it in accordance with Diagram.1 below.

" THIS APPLIANCE DELIVERS WATER NOT EXCEEDING 50°C IN ACCORDANCE WITH AS 3498"

If the front cover of the appliance does NOT contain the above text, install it in accordance with Diagram.2 below.

IMPORTANT: If the appliance is to deliver water primarily for the purposes of personal hygiene in an early childhood centre, primary or secondary school, nursing home or similar facility for young, aged, sick or disabled persons as defined in AS/NZ3500.4 a Temperature Limiting Device (TLD), such as a Tempering Valve, may be required even if the appliance is set to 50° C or less. For these types of applications contact Rinnai.

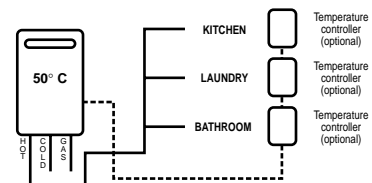

Diagram 1. - 50° C Appliance

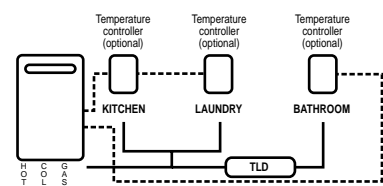

Diagram 2. - Not a 50° C Appliance
Note: TLD = Temperature Limiting Device.

CONNECTING REMOTE CONTROL CABLES



Do not attempt to connect the remote control cable terminals to the appliance with the power on. **RISK OF ELECTRICAL SHOCK !**

Connecting One or Two Controllers

1. Isolate the power supply.
2. Remove the front cover from the Appliance (4 screws) as shown in fig. 1.
3. Thread the cable(s) through the cable access hole at the base of the appliance.
4. **Ensure the position of the terminals for controls** shown on the Printed Circuit Board **COVER**. Connect the spade connectors to the terminals on the P.C.B. (fig. 2) Polarity is not important. Either wire colour can be connected together terminal.
5. Replace cover of the appliance, ensuring that the screw with the star washer is placed at the bottom right hand corner for earthing purposes.

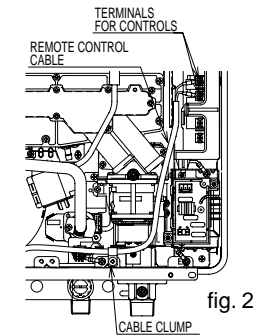
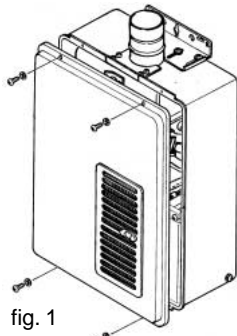

Connecting Three Controllers

1. Isolate the power supply.
2. Remove the front cover from the Appliance (4 screws) as shown in fig. 1.
3. Cut the spade connectors from 2 of the controller cables to be connected to the appliance (4 spade connectors should be cut off) and discard. Connect the wires from these two cables and terminate into two new spade connectors as shown in fig 3. Spade connectors are available from your local electrical component retailer.
4. Thread the 3 cables through the cable access hole at the base of the appliance.
5. **Ensure the position of the terminals for controls** shown on the Printed Circuit Board **COVER**. Connect the 4 spade connectors to the terminals on the P.C.B. (fig. 2) Polarity is not important. Either wire colour can be connected to either terminal.
6. Replace cover of the appliance, ensuring that the screw with the star washer is placed at the bottom right hand corner for earthing purposes.

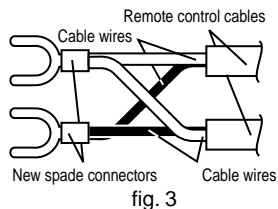

TESTING AND COMMISSIONING



DURING PRESSURE TESTING OF THE INSTALLATION ENSURE GAS COCK SITUATED BEFORE UNIT IS SHUT-OFF.

FAILURE TO DO SO MAY RESULT IN SERIOUS DAMAGE TO THE APPLIANCE AND POSSIBLE INJURY.

1. Before final connection of the water heater purge gas, hot and cold water supply lines. Swarf in either the gas or water supplies may cause damage.
2. Turn on gas and cold water supplies.
3. Test for water leaks and gas escapes near the appliance.
4. Isolate gas supply. Remove test point screw located on the gas inlet connection and attach pressure gauge.
5. Turn the power 'on' at the power point socket.
6. If remote controllers are fitted, turn the controller 'on', select the maximum delivery temperature and open ALL available hot water taps including the shower. If remote controllers are not fitted, simply open all available hot water taps. (**CAUTION:** Ensure building occupants do not have access to hot water outlets during this procedure.)
7. Operate ALL other gas appliances at their maximum gas rate, in accordance with manufacturers instructions.

8. With all gas appliances in operation at maximum gas rate, the pressure should read between 1.13 - 3.0 kPa on Natural Gas. On LPG the pressure should be 2.75 - 3.0 kPa. If the pressure is lower, the gas supply is inadequate and the appliance will not operate to specification. Check gas meter, regulator and pipe work for correct operation/sizing and rectify as required. Note that the gas regulator on the appliance is electronically controlled and factory pre-set. Under normal circumstances it **DOES NOT** need adjustment during installation.
9. Close hot water taps including the shower.
10. Inspect and clean the strainer located on the cold water inlet connection. This procedure may need to be repeated to ensure the strainer remains clear, especially on new installations.
11. If Temperature Controllers are fitted, it is necessary to test their operation through the complete range of functions (refer to the 'How to use your Water Heater' booklet).
12. Confirm the hot water delivery temperature(s) using a thermometer. If controllers are fitted, ensure temperatures exceeding 50° C cannot be selected on bathroom or ensuite controllers.
13. After testing is completed, explain to the occupant the functions and operation of the water heater and temperature controllers (if fitted). Ensure the 'Customer Record' section of the 'How to use your Water Heater' booklet is filled in and that the booklet is handed to the customer, reminding them to complete the Warranty Card and forward to Rinnai.

GAS PRESSURE SETTING

The regulator on the appliance is electronically controlled and factory pre-set. Under normal circumstances it does not require adjustment during installation. Perform this procedure only if the unit is not operating correctly and all other possible causes for incorrect operation have been eliminated.

1. Turn 'OFF' the gas supply.
2. Turn 'OFF' 240V power supply.
3. Remove the front cover from the appliance.
4. Check gas type switches (fig. 1) are in the correct position (dip switch 1 of SW2 'ON' = NG, 'OFF' = LPG).
5. Attach pressure gauge to burner test point, located on the gas control. (fig. 2)
6. Turn 'ON' the gas supply.
7. Turn 'ON' 240V power supply.

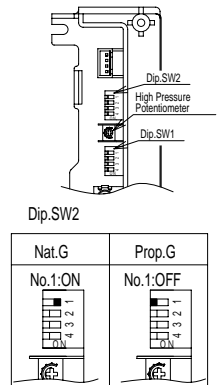

fig. 1

8. If remote controllers are fitted, turn the unit 'ON' at the kitchen controller, select the maximum delivery temperature of 55° C and open a hot water tap fully. (**CAUTION:** Ensure building occupants do not have access to hot water outlets during this procedure).
9. To set the appliance to 'Forced Low' combustion, switch No. 3 dip switch of the SW1 set of dip switches to 'ON'. (fig. 3)

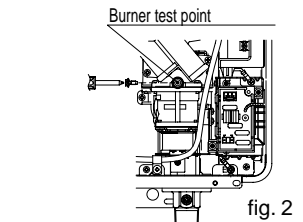

fig. 2

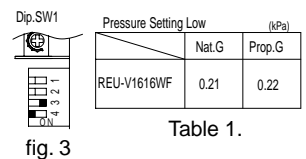

fig. 3

Table 1.

10. Check the burner test point pressure.
11. Remove rubber access plug and adjust the regulator screw on the modulating valve (fig. 4) as required to the pressure. Table 1. Replace rubber access plug.

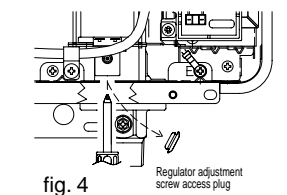

fig. 4

12. To set the appliance to 'Forced High' combustion, switch both No. 3 and No. 4 dip switches of the SW1 set of dip switches to 'ON'. (fig. 5) Ensure maximum water flow.

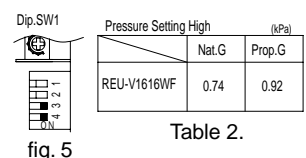

fig. 5

Table 2.

13. Check the burner test point pressure.

14. Adjust the high pressure Potentiometer (POT) on the Printed Circuit Board (PCB) as required to the pressure shown Table 2. (fig.1)

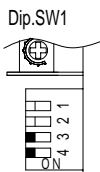

fig. 6

16. Close hot water tap.

17. Turn OFF the gas supply and 240V power supply.

18. Remove pressure gauge, and replace sealing screw.

19. Turn 'ON' the gas supply and 240V power supply.

20. Operate unit and check for gas leaks at test point.

21. Replace cover of the appliance, ensuring that the screw with the star washer is placed at the bottom right hand corner for earthing purposes.

Appendix 1. MC 91-1A CONTROLLER PROGRAMMING

Is your water heater labelled "THIS APPLIANCE DELIVERS WATER NOT EXCEEDING 50°C IN ACCORDANCE WITH AS 3498" on the front cover ?

IF YES: No further action required.

IF NO: You will need to program the kitchen controller to enable selection of temperatures higher than 50° C.

STEP 1: For the controller in the KITCHEN only, press and hold the 'Transfer' and 'On/Off' buttons simultaneously (see fig. 1) until a 'beep' is heard (approximately 5 seconds).

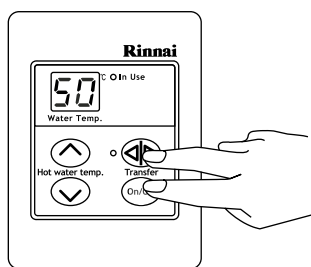
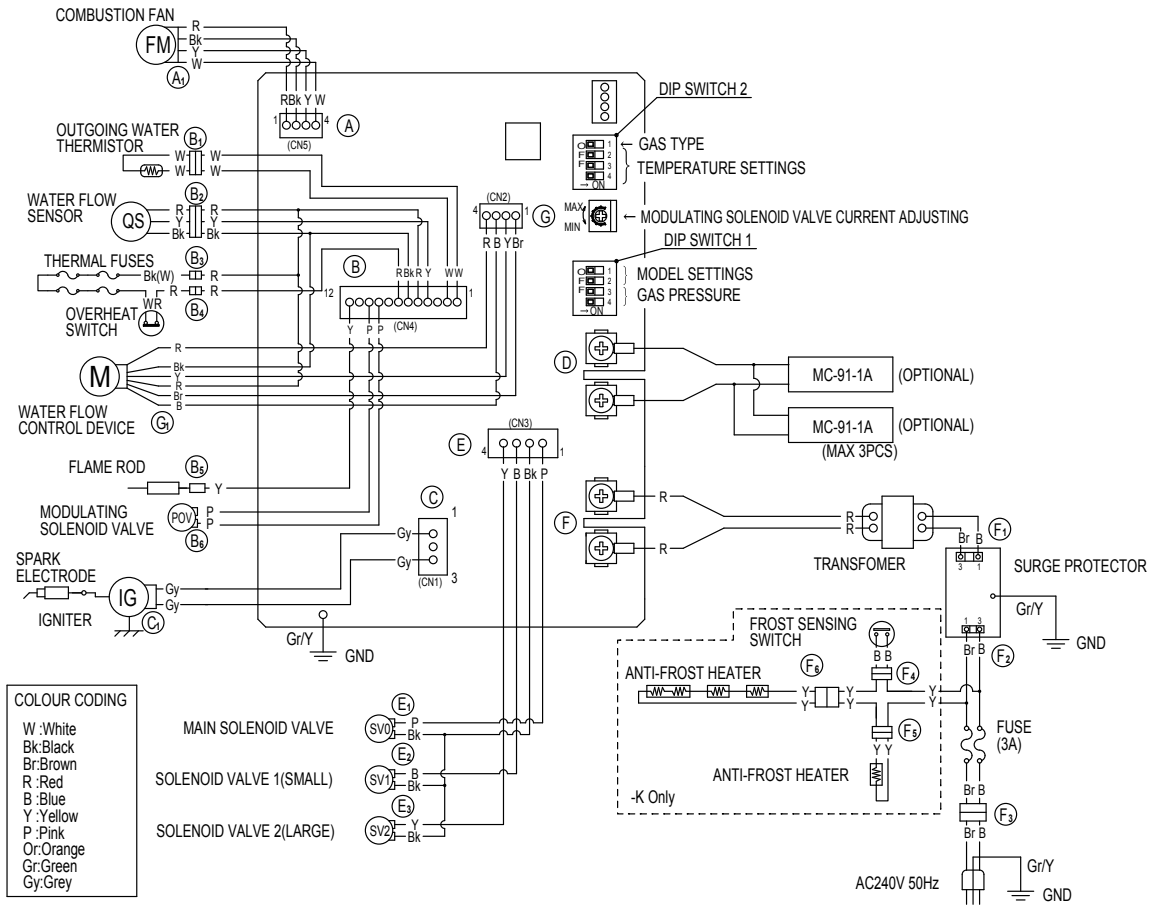

fig. 1

STEP 2: When the controller fitted in the KITCHEN is switched on, it should be possible to select temperatures higher than 50° C. If not, repeat Step 1.

Note:

- If the kitchen controller is replaced, repeat STEP 1 above for the replacement controller.
- If the kitchen controller is swapped with another controller (for example, the controller fitted in a bathroom), repeat STEP 1 for the controller moved from the kitchen to the bathroom. Then perform STEP 1 for the controller moved from the bathroom to the kitchen.



TRANSFORMER VOLTAGES AND RESISTANCES

FLOW CHART No.	COMPONENT	MEASUREMENT POINT		NORMAL VALUE	A NOTE
		CN	WIRE COLOUR		
①	SURGE PROTECTOR	F ₃	B-Br	AC207-264V	
② ⑭	WATER FLOW CONTROL DEVICE	G ₁	R(CN2-NO.4)-B R(CN4-NO.5)-Bk	± DC11~13V (ONLY WHEN OPERATING) DC11~13V	OPERATE ELECTRICITY CONTROL ELECTRICITY
			Bk-Y	BELOW DC1V(LIMITER ON) DC4~6V(LIMITER OFF)	FULL OPEN POSITION
			Bk-Br	BELOW DC1V(LIMITER ON) DC4~6V(LIMITER OFF)	FULL CLOSE POSITION
③	REMOTE CONTROL	D	(TERMINAL)	DC11~13V	
④	WATER FLOW SENSOR	B ₂	R-Bk	DC11~13V	ON2.4L/MIN (33Hz) OVER 1980PULSE/MIN
			Y-Bk GND	DC4~7V(PULSE 20~320Hz)	OFF 1.7L/MIN(23Hz) BELOW 1380PULSE/MIN
⑤	COMBUSTION FAN	A ₁	R-Bk	DC15~46V	
			Y-Bk	DC11~13V	
			W-Bk GND	DC5~10V(20~400Hz)	
⑥	FLAME ROD	B ₅	Y-FLAME ROD	OVER DC1μA	FLAME CONDITION
⑦	MODULATING SOLENOID VALVE	B ₆	P-P	DC2~15V 65~85 Ω	
⑧	OUTGOING WATER THERMISTOR	B ₁	W-W	15°C... 11.4~14.0 k Ω 30°C... 6.4~7.8 k Ω 45°C... 3.6~4.5 k Ω 60°C... 2.2~2.7 k Ω 105°C... 0.6~0.8 k Ω	
⑨	THERMAL FUSES	B ₃	R-W	BELOW 1 Ω	
		B ₄	R-Bk		
⑩	IGNITER	C ₁	Gy-Gy	AC90-110V	
⑪	MAIN SOLENOID VALVE	E ₁	P-Bk	DC80~100V 1.7~2.1 k Ω	
⑫	SOLENOID VALVE 1 (SMALL)	E ₂	B-Bk	DC80~100V 1.7~2.0 k Ω	
⑬	SOLENOID VALVE 2 (LARGE)	E ₃	Y-Bk	DC80~100V 1.7~2.1 k Ω	

CN	WIRE COLOUR	NORMAL VALUE
F	R-R	AC90-110V 11-13 Ω
F ₁	B-Br	31-36 Ω

WATER HEATER DIMENSIONS

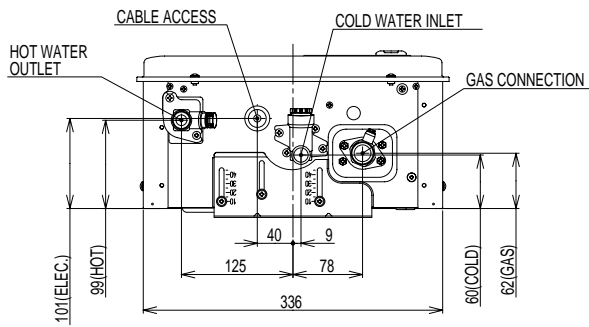
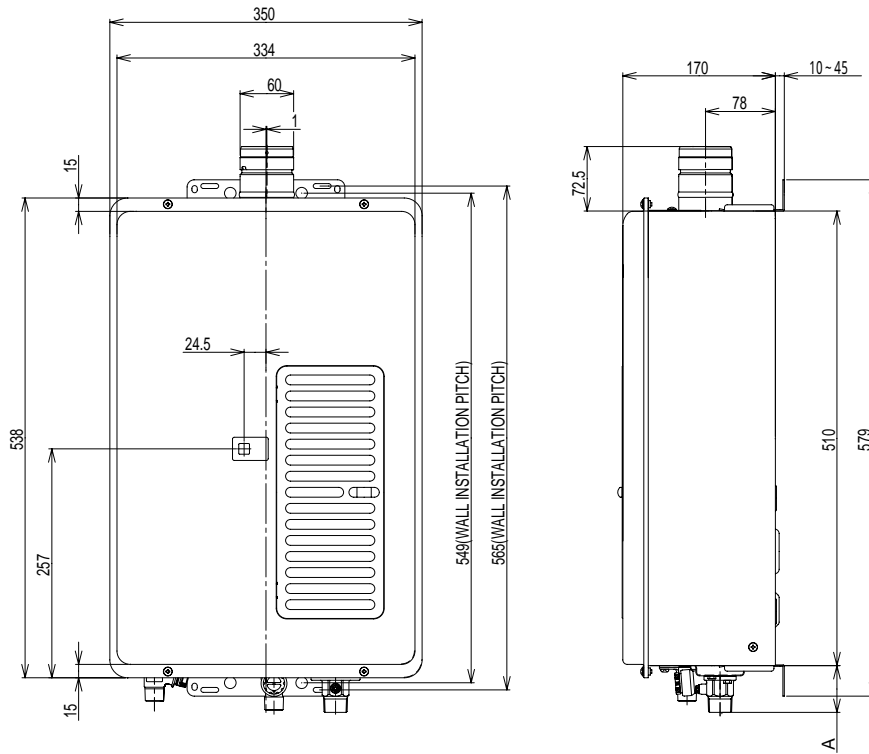

	A DIMENSION (mm)	CONNECTION
GAS	52	R 3/4 (20mm)
COLD	50	R 1/2 (15mm)
HOT	42	R 1/2 (15mm)
CABLE ACCESS	3	—

REMOTE CONTROLLER DIMENSIONS

MC-91-1A

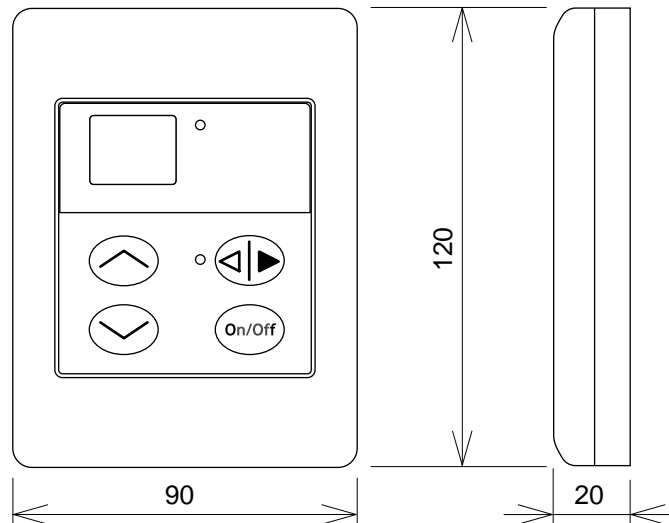



080 00012 39156 3