

This diagram is provided to assist you to identify parts if replacement is necessary. Contact your place of purchase or the manufacturer to enquire about parts, availability and/or service.

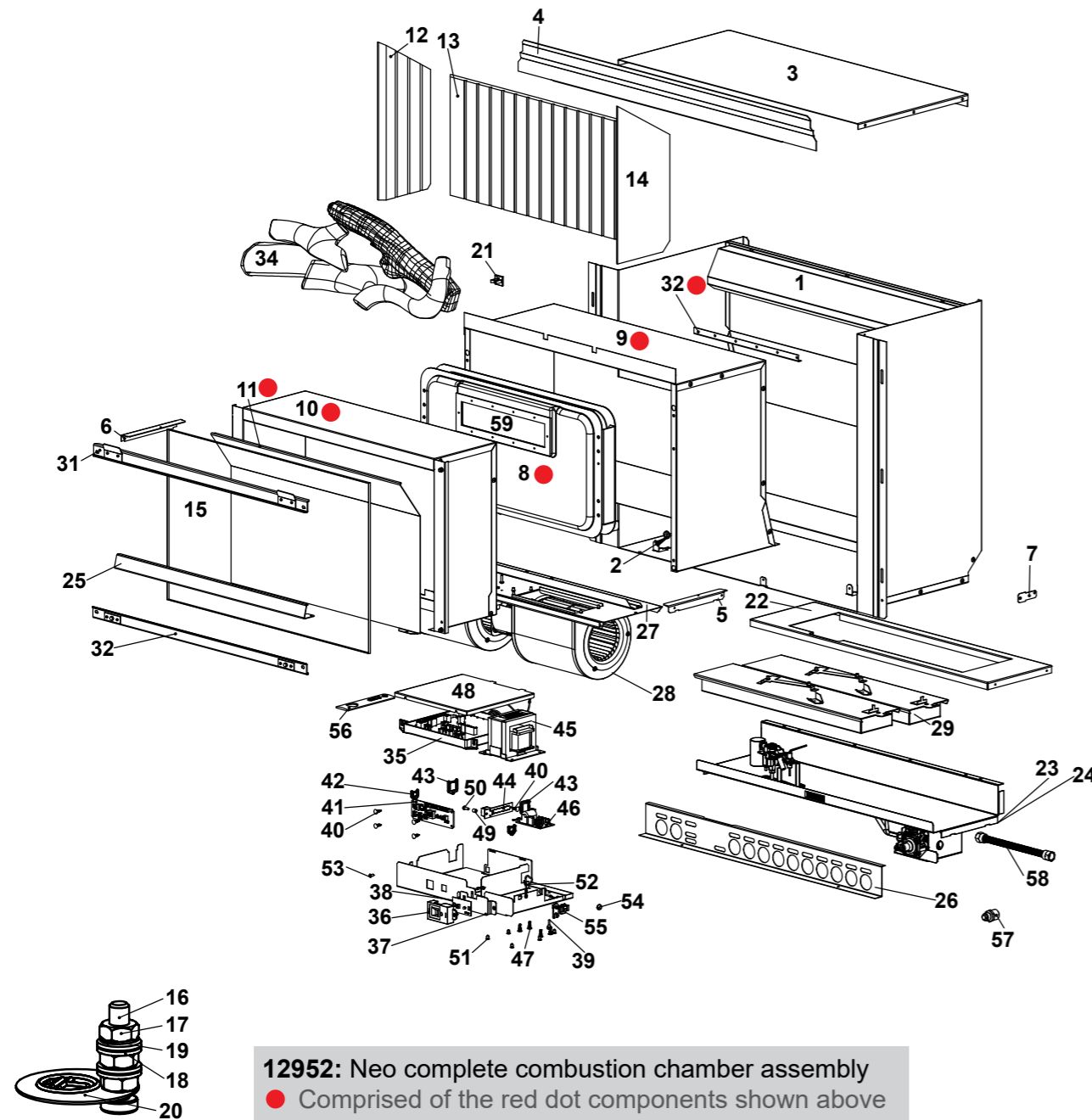

Ref.	Part No.	Description	Qty.
1	13120B	Body outer assembly painted	1
2	7132	Rubber grommet power cord	1
3	11854	Panel top	1
4	11855B	Top panel trim painted	1
5	11860	Fan mounting bracket RH	1
6	11859	Fan mounting bracket LH	1
7	11865	Surround retaining bracket	2
8	11964	Heat exchanger assembly	1
9	12159F	Outer air guard spare	1
10	11870F	Combustion chamber assembly	1
11	12319F	Heat shield painted	1
12	12366	Ceramic panel groove LH	1
13	12367	Ceramic panel groove rear	1
14	12368	Ceramic panel groove RH	1
15	11966	Glass replacement assembly	1
16	9073	Screw M4 x 20 phillips pan head zinc	1
17	9186	Nut M4 ZP	3
18	9231	Washer flat M4 ZP	4
19	9233	Washer spring M4 ZP	1
20	11269	Tag earth symbol	1
21	10309	Cable clip	3
22	13131F	Burner surround painted	1
23, 24, 25	-	Gas control assembly—see p. 3	1
26	13134F	Pilot shield black	1
27	13132B	Burner air intake painted	1
28	11965	Fan replacement assembly	1
29	11886F	Burner assembly black NG	1
29	13082F	Burner assembly black LPG	1
31	11962	Glass retainer top assembly	1
32	11963	Glass retainer bottom assembly	1
33	12369	Bracket flue outlet guide	1
34	13799	Log set*	1
-	2544	Granule pack*	
* Correct positioning of the log set and granules are critical to performance. Always follow the instructions detailed in the installation guide.			
35	12811	EL slide base	1
36	12966	PCB main spare	1
37	10394	PCB case receiver	1
38	11304	Self fix bumper	2
39	10393	PCB receiver	1
40	10428	PCB spacer	5
41	10253	PCB display	1

Ref.	Part No.	Description	Qty.
42	1880	Protector plastic edge EHS11U	1
43	10471	Protector plastic edge EHS18U	2
44	12494	Interface board	1
45	10258	Transformer	1
46	13006	Igniter	1
47	9004	PCB spacer black	4
48	12949	PCB box lid	1
49	13066	Spacer M4 clearance 7 mm high	1
50	9070	Screw M4 x 12 c/w washer	1
51	9315	Rivet pop plain 73 AS 5.2	9
52	4417	Wire tie 80 mm	3
53	9063	Screw M4 x 8 pan phil zinc	3
54	6749	Rubber grommet	1
55	7540	Thermistor holder	1
56	13040	IR remote control	1
57	5074	Reducing flare 3/8 x 1/2 BF	1
58	7835	Flextube 3/8 x 8 c/w 5/8-18 nuts	1
59	10925	Heat exchanger gasket (rectangle)	1
-	R7010	Glass seal replacement kit 2m	1

This diagram is provided to assist you to identify parts if replacement is necessary. Contact your place of purchase or the manufacturer to enquire about parts, availability and/or service.

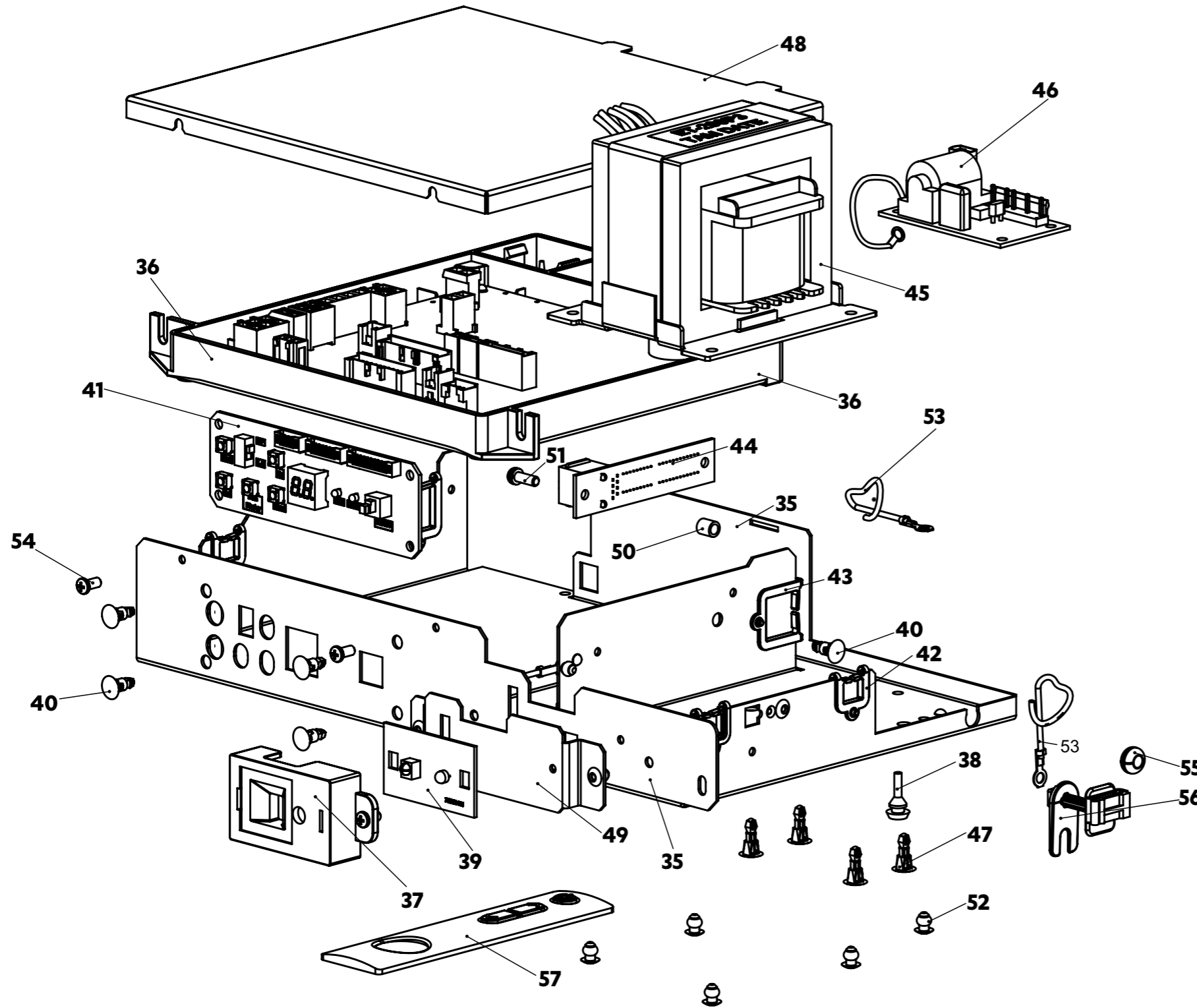

Ref.	Part No.	Description	Qty.
35	12811	EL slide base	1
36	12966	PCB main spare	1
37	10394	PCB case receiver	1
38	11304	Self fix bumper	2
39	10393	PCB receiver	1
40	10428	PCB spacer	5
41	10253	PCB display	1
42	1880	Protector plastic edge EHS11U	3
43	10471	Protector plastic edge EHS18U	2
44	12494	Interface board	1
45	10258	Transformer	1
46	13006	Igniter	1
47	9004	PCB spacer black	4
48	12929	PCB box lid	1
49	13124	Mounting bracket receiver	1
50	13066	Spacer M4 clearance 7 mm high	1
51	9070	Screw M4 x 12 c/w washer	1
52	9315	Rivet pop plain 73 AS 5.2	9
53	4417	Wire tie 80 mm	3
54	9063	Screw M4 x 8 pan head phillips zinc	3
55	6749	Rubber grommet	1
56	7540	Thermistor holder	1
57	13040	IR remote control	1

Components not drawn

-	10284	Harness control panel	1
-	10387	Wire earth combustion fan	1
-	11925	Cable CAT5 x 1.4 m	1
-	12492	Harness 12-way control panel	1
-	12496	Harness 9-way control panel	1
-	12656	Harness receiver	1
-	13004	Ferrite clamp	2
-	13008	Harness flame rod	1
-	13011	Thermal fuse	1
-	13012	Harness POV	1
-	13013	Harness magnetic valve relay	1
-	13014	Harness main gas control	1
-	13032	High tension lead	1
-	13483	Harness thermistor OH1 uni control	1
-	13042	Power cord universal control	1

This diagram is provided to assist you to identify parts if replacement is necessary. Contact your place of purchase or the manufacturer to enquire about parts, availability and/or service.

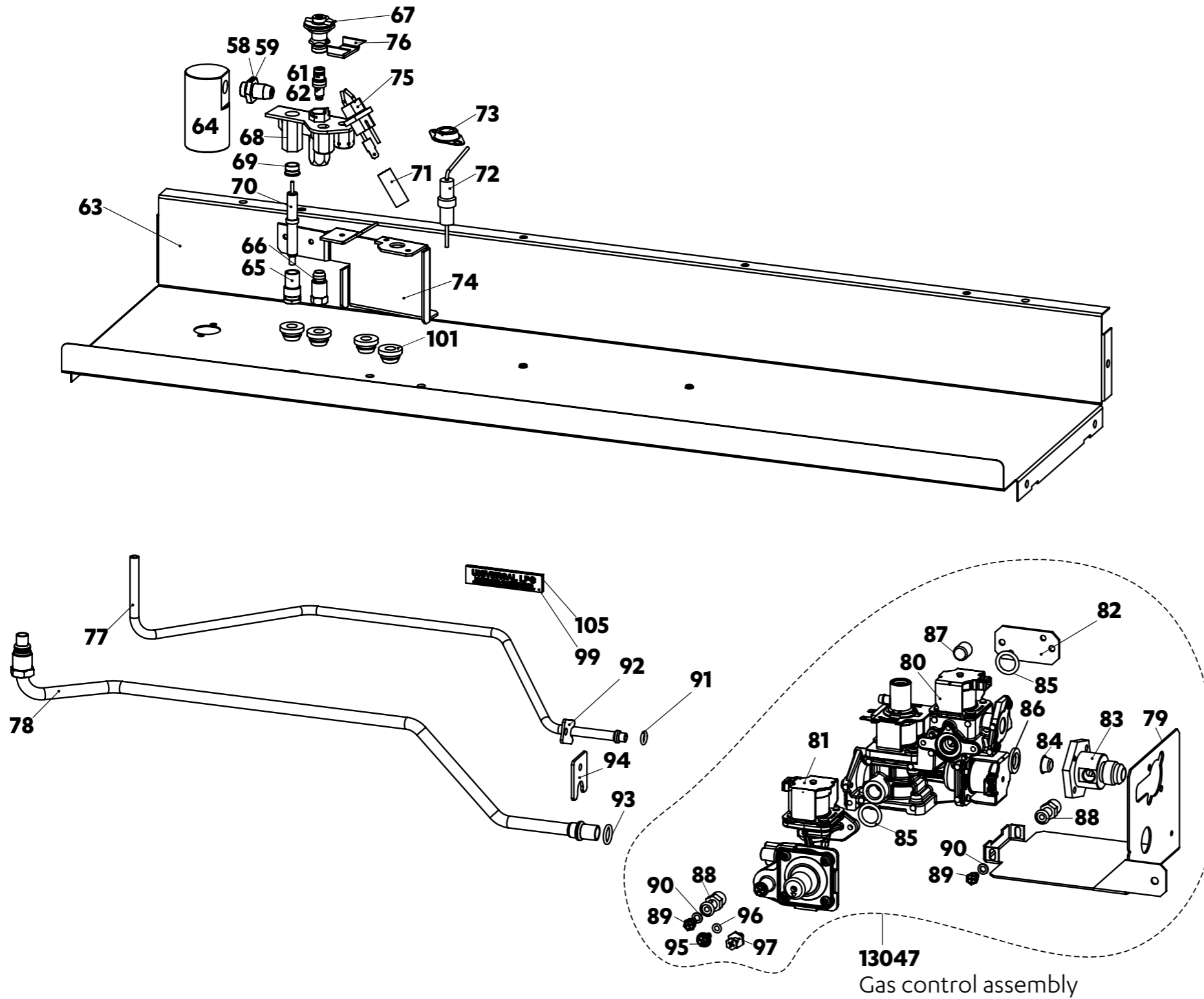

Ref.	Part No.	Description	Qty.
58	11892	Injector 2.8 mm NG	1
59	11868	Injector 1.55 mm ULPG	1
61	7795	Injector NG 0.62 mm NG	1
62	7873	Injector pilot LPG 0.35 mm	1
63	13125	Burner support	1
64	11530	Injector block	1
65	7900	Electrode nut ETR	1
66	7519	Olive 6 mm	1
67	10272	Pilot convertible hood 3-flame	1
68	7870	Pilot body top convertible	1
69	7902	Sparker electrode pilot	1
70	7875	Electrode	1
71	12931	Electrode sheath silicone (2 pack)	1
72	12620	Flame rod with electrode	1
73	3068	Flame rod bracket	1
74	13126	Pilot bracket	1
75	10265	Electrode double	1
76	13043	Electrode clamp universal controller	1
77	13129	Pilot tube	1
78	13128	Gas supply tube assembly	1
79	13026	Mounting bracket	1
80	13000	Gas valve main	1
81	13001	Pilot regulator	1
82	13003	Cover plate	1
83	13015	Gas inlet adaptor 3/8 flare	1
84	13019	Filter RCK-6808-2	1
85	13020	O-ring M10B-1-14	2
86	10290	Packing	1
87	6243	Plug dryseal pressure 1/8" BSP	1
88	9992	Pressure test point	2
89	3564	Test point screw	2
90	2239	O-ring M10B-13-4	2
91	6308	O-ring M10B-1-6	1
92	13028	Tube clamp 6 mm	1
93	2389	O-ring M10B-1-10	1
94	10329	Tube clamp 10	1
95	3564	Test point screw C10D-5-1	1
96	2239	O-ring M10B-13-4	1
97	6700	Adjustment screw c/w nut	1
99	7349	Label Natural Gas	1
101	10767	Grommet kit	1
105	7348	Label Universal LPG	1

This diagram is provided to assist you to identify parts if replacement is necessary. Contact your place of purchase or the manufacturer to enquire about parts, availability and/or service.

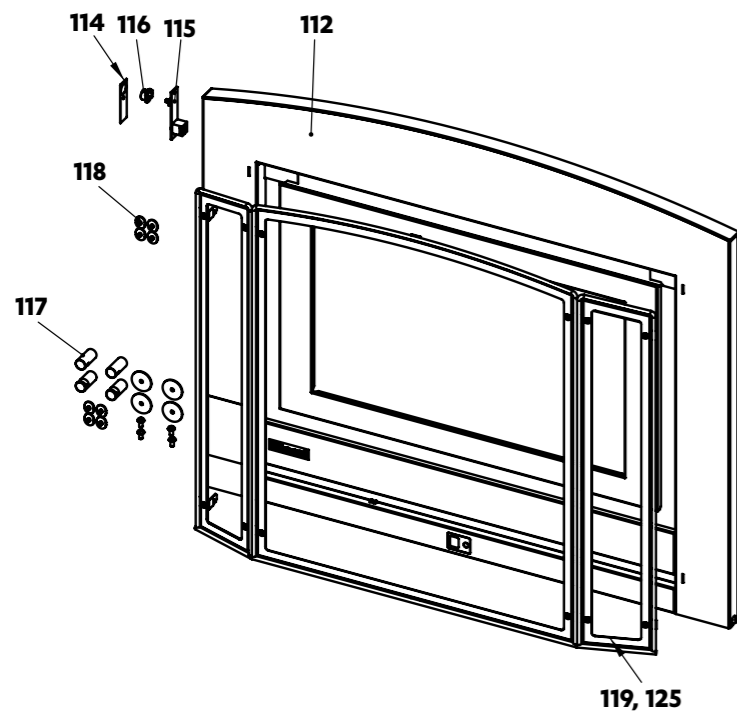
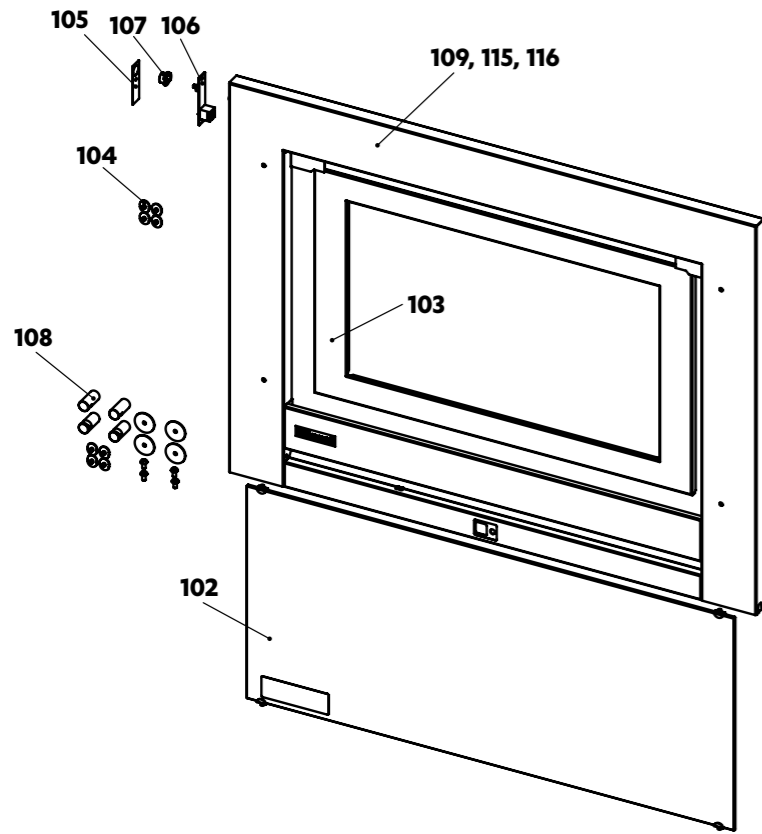

Standard frame

Ref.	Part No.	Description	Qty.
102	11973	Glass guard replacement	1
103	11974	Inner frame replacement - stainless steel	1
103	11975	Inner frame replacement - black	1
104	11977	Grommet set 4-glass standoff	1
105	12139	Control label	1
106	12999	Manual control switch	1
107	10250	Button	1
108	11976	Standoff replacement set	1
109	13135	Frame replacement galaxy black*	1
110	13136	Frame replacement stainless*	1
111	13137	Frame replacement stainless/black*	1

* Frame replacement also includes manual control switch (12999), control label (12139), and button (10250)

Inbuilt Classic Premium frame

Ref.	Part No.	Description	Qty.
112	1318	Frame replacement classic	1
113	11893B	Glass frame black	1
114	12139	Control label	1
115	12999	Manual control switch	1
116	10250	Button	1
117	11976	Standoff replacement set	1
118	11977	Grommet set 4-glass standoff	1
119	12123SH	Classic guard assembly wire frame silver	1
120	12123BZ	Classic guard assembly wire frame bronze	1

* Frame replacement also includes manual control switch (12999), control label (12139), and button (10250)