



Linear Gas Fireplace Collection

Specification guide

Rinnai

Important

Rinnai is constantly improving its products, and as such, information and specifications are subject to change without notice. For the most up-to-date information, go to www.rinnai.co.nz.

Help is here

For more information about buying, using, and servicing of Rinnai appliances call 0800 RINNAI (0800 746 624).

Rinnai New Zealand Limited
105 Pavilion Drive, Mangere, Auckland
PO Box 53177, Auckland Airport, Auckland 2150

Phone: 09 257 3800
Email: info@rinnai.co.nz
Web: www.rinnai.co.nz
www.youtube.com/rinnainz
www.facebook.com/rinnainz

Contents

The Linear Collection.....	4
Specification	6
Unit dimensions	7
Clearances to combustibles	8
Hearths	9
TV installation	10
Cavity ventilation for the room thermistor	11
Linear 800 framing dimensions	12
Linear 1000 framing dimensions	13
Linear 1500 framing dimensions	14
Linear Indoor-Outdoor critical dimensions.....	15
Burn media	17
Accessories	18
Flueing options	20
Flue components	22
Linear ordering guide.....	24
Running costs.....	26

The Linear Collection

Designed and made in New Zealand

Rinnai's designers took their inspiration from Aotearoa's unique landscapes. They hand selected driftwood washed up on our wild West Coast beaches, and stones to match those shaped by our rivers and tides. These were painstakingly recreated as perfectly lifelike ceramics.

Rinnai's engineers then reinvented gas fire technology so flames burn more realistically and embers glow more brightly. Finally, they captured the flames in frameless panoramic enclosures leaving next to nothing between you and the flickering warmth. The end result is the Linear gas fire collection from Rinnai.

The Linear Collection at a glance

800 double-side FlameTech logs



800 indoor-outdoor FlameTech logs



1000 double-side FlameTech logs



1000 single-side FlameTech logs



1000 single-side modern media



1000 double-side designer logs



1500 single-side designer logs



1500 double-side modern media



Successful installation - the devil is in the detail

With a number of these beautiful fires already installed, we've learned a thing or two. A successful installation is all about the detail. Here's a summary of some of the important details that will ensure a smooth and pain-free installation.

- **Framing dimensions**

The Linear units are not symmetrical, the cavity needs to be framed based on the centreline of the Linear glass, NOT the opening size. Refer to p.12-15 for more information.

- **Wall linings and clearances to combustibles**

There are some aspects of the wall lining installation that are critical to the safe operation of the appliance. One aspect is the free flow of air around the unit. As there are a myriad of wall lining options a supplementary 'Additional guide to installing wall linings' can be found on our website. Information on clearances to combustibles can be found on p.8.

- **Cavity ventilation for the room temperature sensor**

Ventilation of an area of at least 2000 mm² is recommended in the cavity, ideally below the base of the fire. This is to provide air to the temperature sensor located in the base of the fire, which senses the room temperature, refer p.11 for more information.

- **Keeping the area clear in front of the IR receiver**

We've had instances where design, whilst beautiful, has caused IR receiver issues. This includes installing large marble stone, schist walls, and korteen steel directly in front of the IR receiver. We've also had installations where the IR receiver has been painted over. This will severely restrict the distance at which you can operate the fire via Wi-Fi or simple remote. More information on this is included in the installation guide available on our website.

- **Linear Indoor-Outdoor**

The Linear window assembly allows a double-sided Linear model to be installed in an external wall. The fires have been modified to allow for a window installation. Ensure you have ordered the correct model and window kit, refer p.24 for more information.

The Linear Indoor-Outdoor assembly is **unable to be retrofitted** to an existing Linear double-sided model as customisation is needed to fit a window—a new fire would be required.

Specification

Inbuilt power flued convection fan fire operated by a simple infra-red remote, or by the Rinnai Wi-Fi app that allows full thermostatic control as well as other features such as timers. Different burn media options available.

Specification summary

	Input	Output*	Heating area**
800FT 1000FT	15-35 MJ/h	3.5-7.7 kW	71-123 m ²
1000	14-34 MJ/h	3.6-7.4 kW	69-118 m ²
1500	14-40 MJ/h	3.3-8.5 kW	79-135 m ²

* Will vary according to gas type and flue configuration

** Will vary depending on geographical location in NZ

Efficiency = > 75% (all models on high)
Gas type = NG or ULPG



The heat output and heating areas will differ slightly for the single sided and double sided variants. Single sided models will be slightly more efficient.

Suitability

Ideal for living rooms and open plan areas. Versatile power flue system makes for easy installation in almost any living space, including bedrooms.

The Linear is ideal for a new build installation.

Installation considerations

Room size—smaller rooms will heat up quickly, and due to the efficiency of the appliance, if in thermostatic mode, will reduce to a low flame profile.

Installation of the Linear higher up the wall, in some room configurations, can create draughts due to the convection air being pushed out from the top of the appliance.

Convection fan

2-speed fan. Heat is distributed from the top of the appliance.

Data plate - 1500

Base of the combustion chamber towards the left hand side, between the gas control and convection fan access panel.

Data plate - 800/1000

Base of the combustion chamber, left hand side, on the convection fan access panel.

Gas connection

½ " BSP, the gas supply terminates inside the unit—lower left hand side of the appliance.

Ignition: Continuous spark electronic ignition.

Noise level: 37-45 dB(A)

Power flue

Inner 50 mm, outer 70~80 mm. Appliance must be installed with a Rinnai flue system.

Power consumption/electrical supply

High = 50 W
Standby = <8 W

The Linear has a 1.5 m power cord with a three pin plug supplied. The power cord passes through a slot in the right hand side of the appliance.

Safety devices

Flame failure sensing system, pressure relief, overheat safety switch, air temperature sensor, thermal fuse, overcurrent fuse, and spark detection.

Temperature control

The Linear can be operated using the basic infra-red remote, or for more features, such as timers and thermostatic control, using Rinnai's Wi-Fi fireplace controller app.

Weights

	Unit	Packaged
800	100 kg	120 kg
1000	100 kg	125 kg
1500	110 kg	140 kg

Unit dimensions

- These are the unit dimensions only, not the framing dimensions
- The centre of the glass is NOT the centre of the appliance

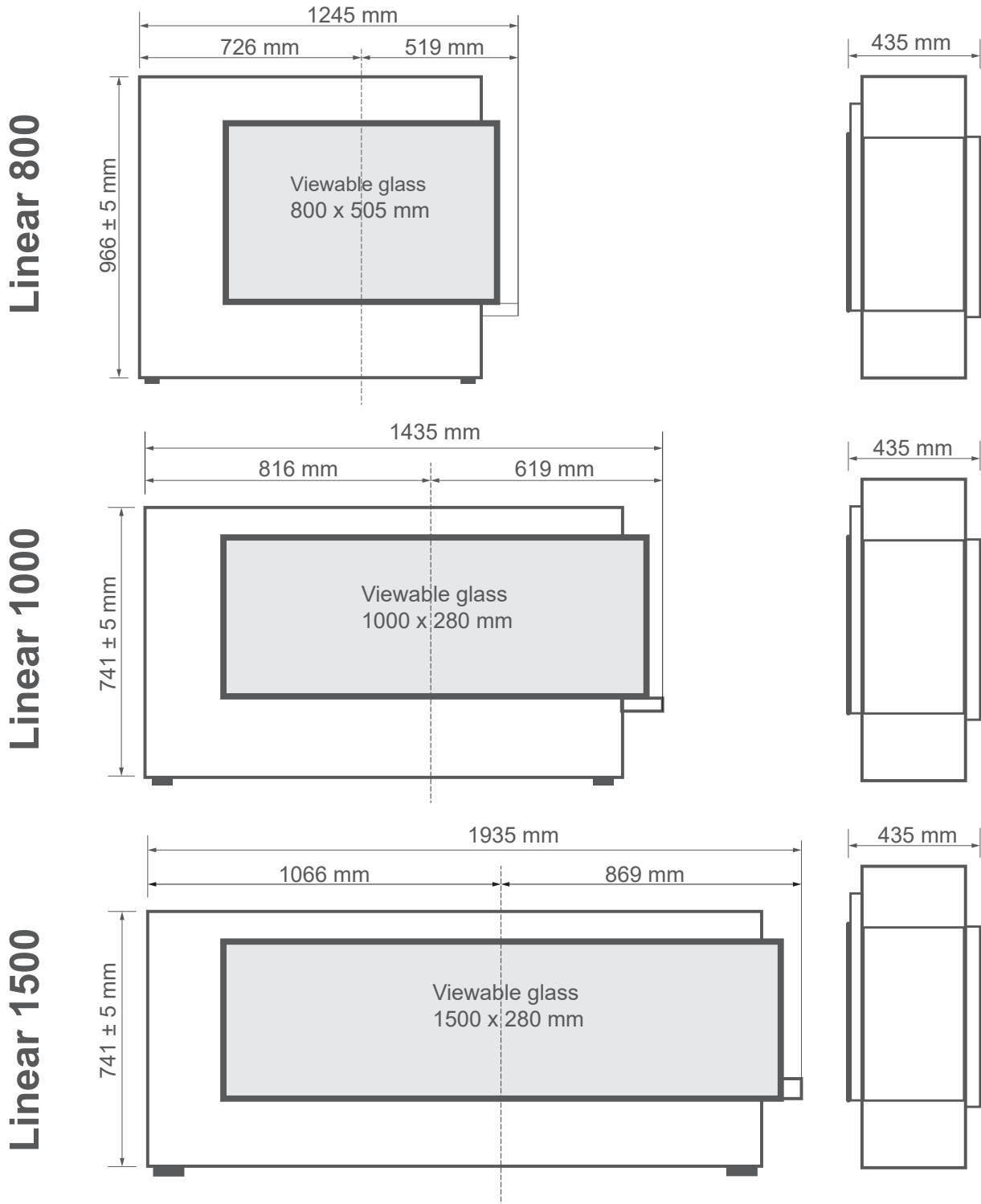

Clearances from combustibles

The clearances listed below, measured from the edge of the glass, are minimum clearances unless otherwise stated.

While the fire is operating

The appliance must not be installed where curtains or other combustible materials could come into contact with the fire. The 400 mm side clearance includes side walls. The 1000 mm clearance is in front of the fire.

Floor protection

Heat emanating from this fire may over time affect the appearance of some materials used for flooring, such as, carpet, vinyl, cork or timber. To avoid this occurring, it is recommended a mat be placed in front of the appliance.

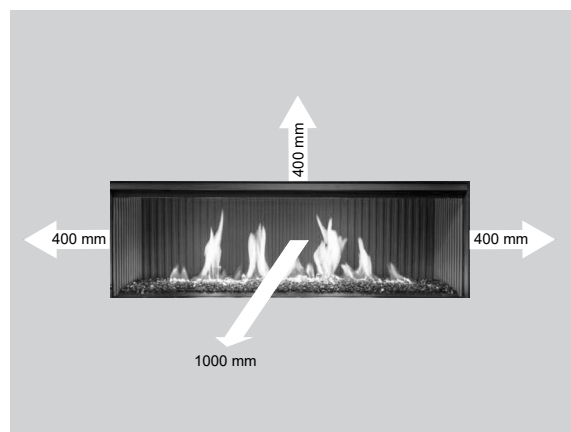

Mantels and surrounds

Combustible mantels and surrounds require clearance from the unit to minimise the risk of fire.

Mantels and surrounds, made of combustible material such as wood are allowed providing they are outside the minimum clearances detailed below.

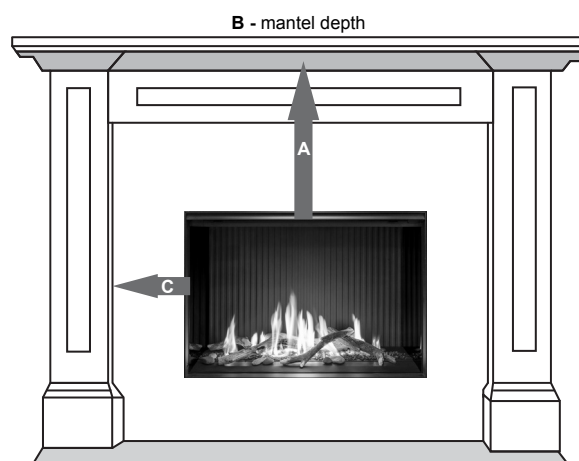

- | | |
|----------|--|
| A | Mantel needs to be a minimum of 400 mm away from the edge of the glass |
| B | Maximum mantel depth at 400 mm (A) is 250 mm maximum |
| C | Surround needs to be a minimum of 400 mm away from the edge of the glass |

For every 50 mm of added mantel depth there must be an additional 100 mm of clearance from the edge of the glass. For example:

Mantel depth: 'A' clearance required

300 mm	500 mm
350 mm	600 mm
400 mm	700 mm

Hearths

Any hearth that is installed in the shaded area (shown below) must be capable of withstanding temperatures up to 100 °C. Some laminated materials may buckle or delaminate when exposed to high levels of heat.

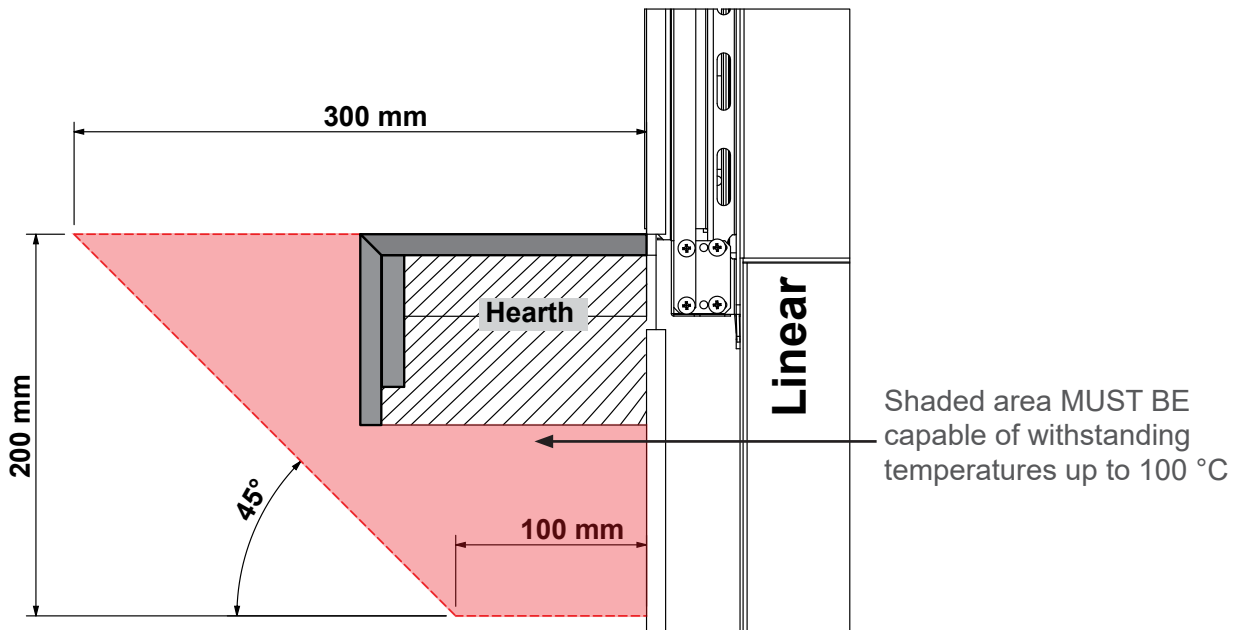

1. A 3 mm air gap between the hearth and lower fire lip is critical. This allows for air flow to critical components and for correct operation of the IR receiver.
2. The lower support rail is only required if the side rails are used, side rails are required for combustible wall linings.
3. The finishing trim latches are not needed if a hearth is installed, they can be snapped off if they are in the way.

TV installation

The Linear has a fan that distributes warm air from the top of the appliance out into the room. As warm air is dispersed outwards and not directly upwards, installation of a TV may be an option.

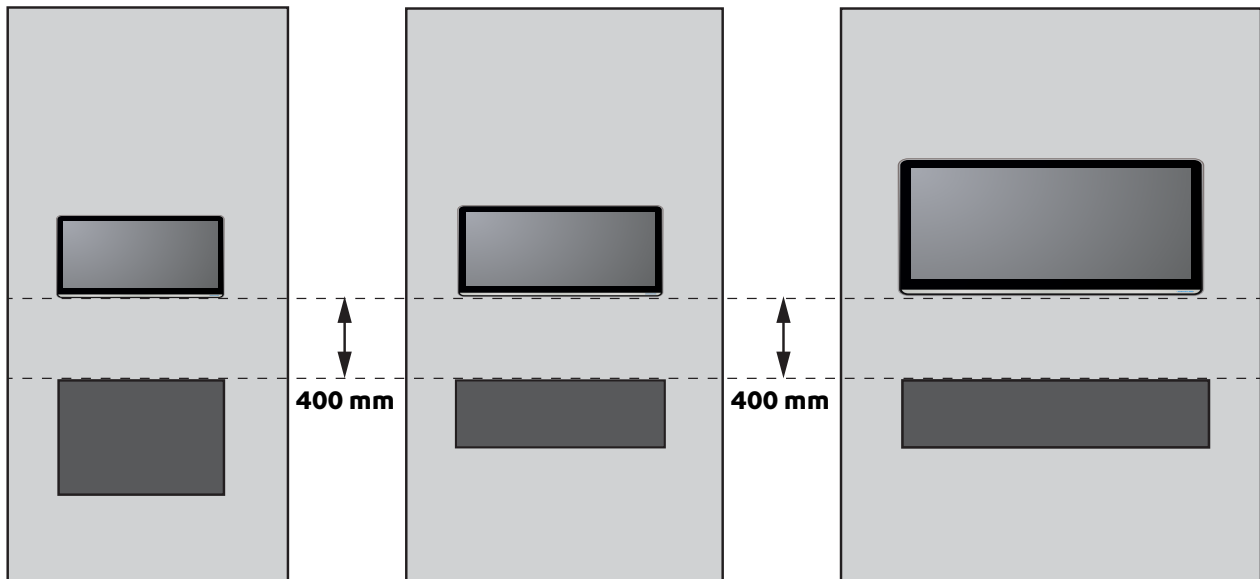

The diagram shows recommended clearances when installing a TV directly above the Linear, or into a recess.

Always check with the TV manufacturer

It is up to the owner to check the TV installation with the TV manufacturer—some have warranty conditions that state a TV is not to be installed above a fireplace.

Rinnai does not accept any responsibility for damage to a TV resulting from the use of this information.

Cavity ventilation for the room temperature sensor

Ventilation of an area of at least 2000 mm² is recommended in the cavity, ideally below the base of the fire. This is to provide room air to the temperature sensor located in the base of the fire, which senses the room temperature. Ventilation can be via a vent or an open toe kick at the base of the cavity.

Alternatively, provide a way of moving the room temperature sensor into the room, for example under the hearth—ensure it can be accessed/removed for service.

Cavity ventilation design ideas

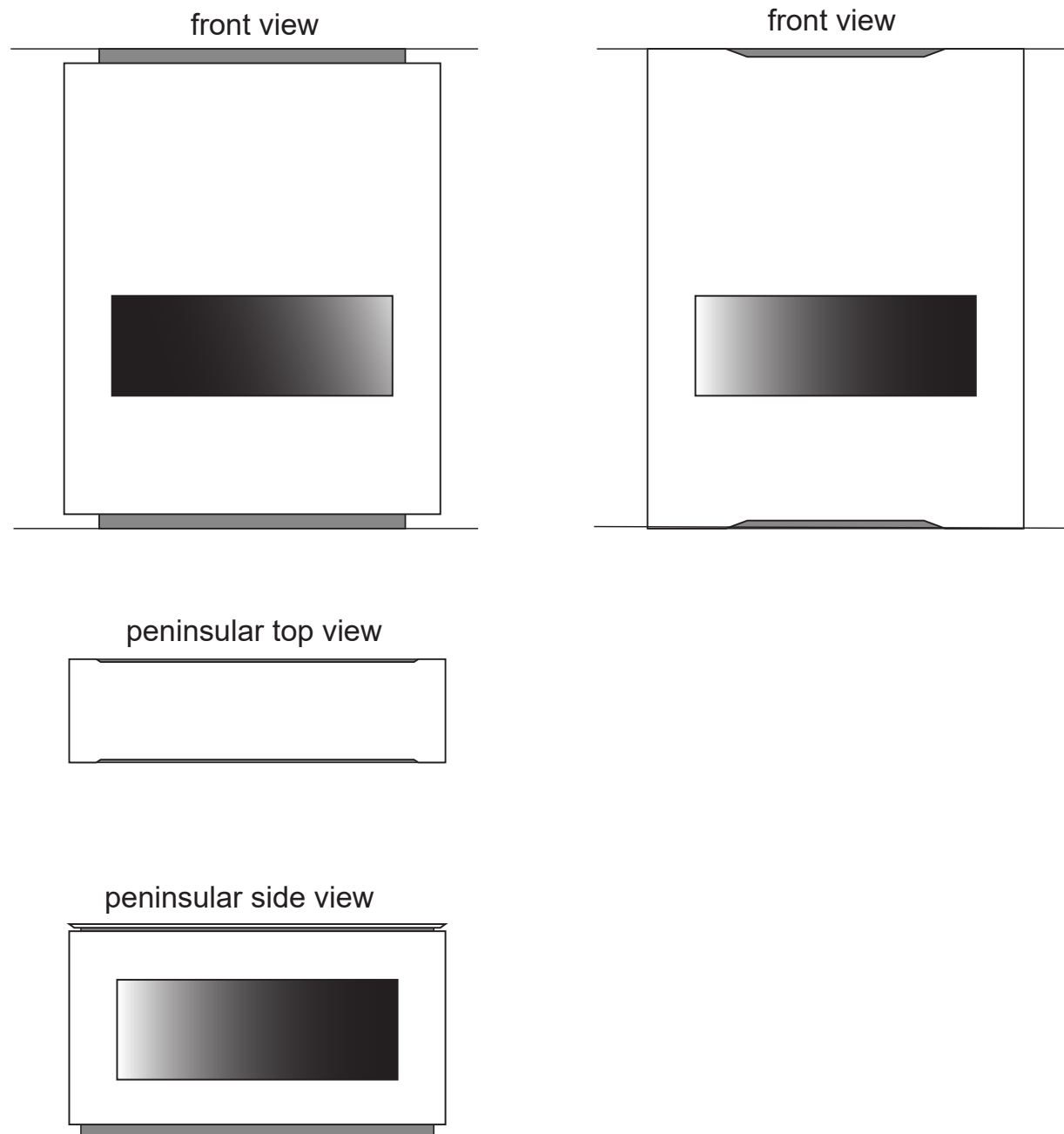

Linear 800 minimum framing dimensions (mm)



The framing dimensions have the studs offset. This is because the cavity needs to be framed based on the **centreline of the Linear glass, NOT the opening size**. Where there is a requirement for a symmetrical installation, the cavity size will need to increase, refer diagram below.

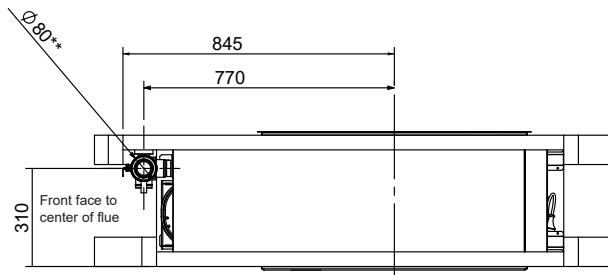

49 assumes 10 mm wallboard

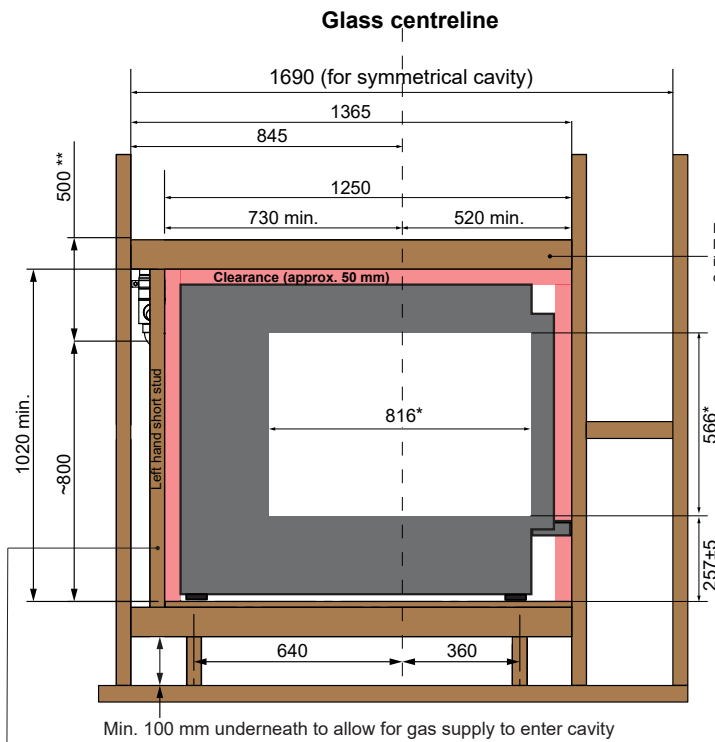
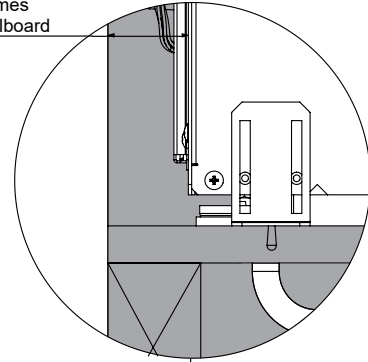

Recommend that the lintel is left until the fire is installed so clearances can be maintained

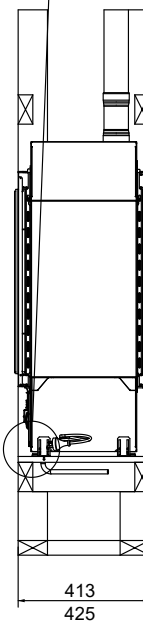

Shaded area is the required clearance area around the fire of approx. 50 mm. On the RHS this is automatically achieved with the carry bar.

IMPORTANT: Maintain the 50 mm clearance around the unit, even for non-combustible material. The RHS of the fire gets very hot and can transfer heat. Real-life example, a section of steel framing butted up to the RHS transferred heat to a plaster wall causing it to crack.

To give extra room the left hand short stud can be left out until the Linear is installed.

- * Minimum wallboard cutout if using the outer finishing trim
- ** Maintain 25 mm clearance to combustibles for the first 500 mm of flue

- All dimensions are assuming a 10 mm wallboard
- Studs and joists are required directly below the support feet of the fire
- Framing shown is 90 x 45 mm
- Fire platform shown is 18 mm plywood

Linear 1000 minimum framing dimensions (mm)



The framing dimensions have the studs offset. This is because the cavity needs to be framed based on the centreline of the Linear glass, **NOT** the opening size. Where there is a requirement for a symmetrical installation, the cavity size will need to increase, refer diagram below.

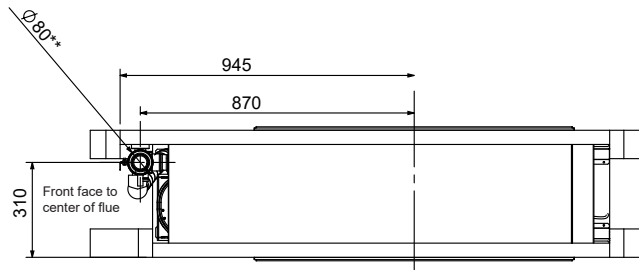

49 assumes 10 mm wallboard

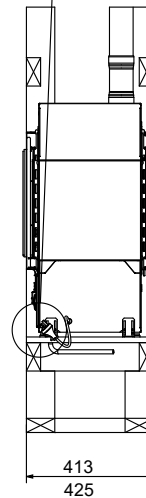
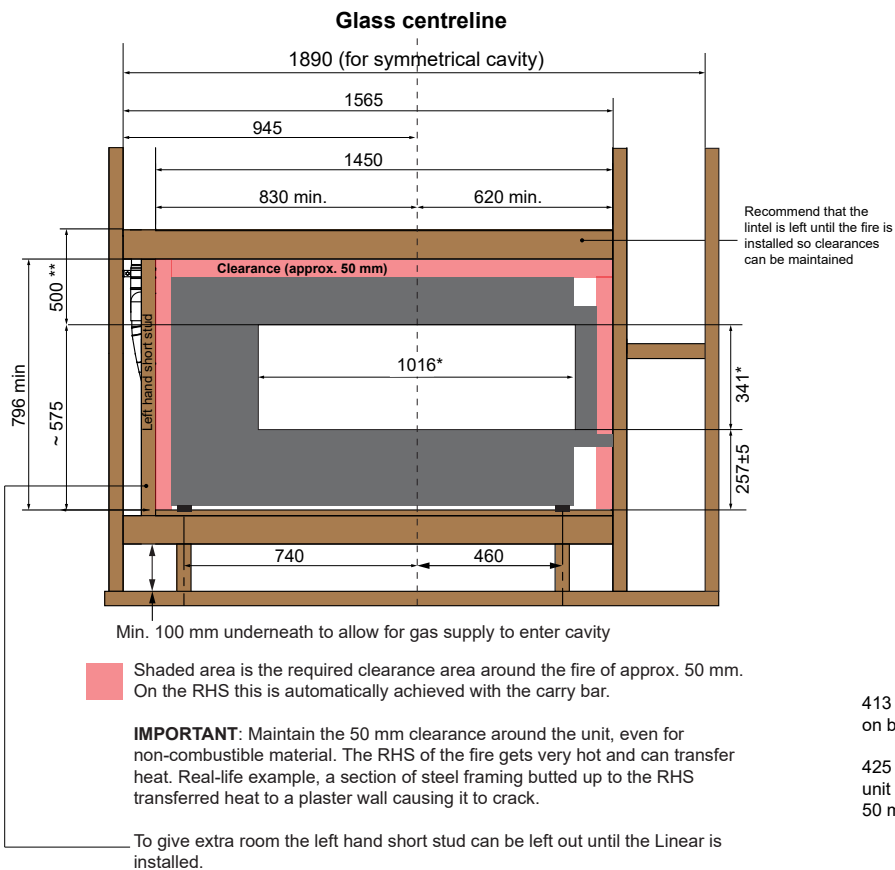
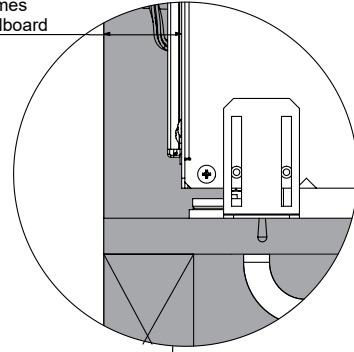

413 mm assumes a 10 mm wallboard on both sides of a double-sided unit.

425 mm is the min. for a single-sided unit with 10 mm wallboard to maintain 50 mm clearance to the back of the fire.

- * Minimum wallboard cutout if using the outer finishing trim
- ** Maintain 25 mm clearance to combustibles for the first 500 mm of flue

- All dimensions are assuming a 10 mm wallboard
- Studs and joists are required directly below the support feet of the fire
- Framing shown is 90 x 45 mm
- Fire platform shown is 18 mm plywood

Linear 1500 minimum framing dimensions (mm)



The framing dimensions have the studs offset. This is because the cavity needs to be framed based on the centreline of the Linear glass, **NOT** the opening size. Where there is a requirement for a symmetrical installation, the cavity size will need to increase, refer diagram below.

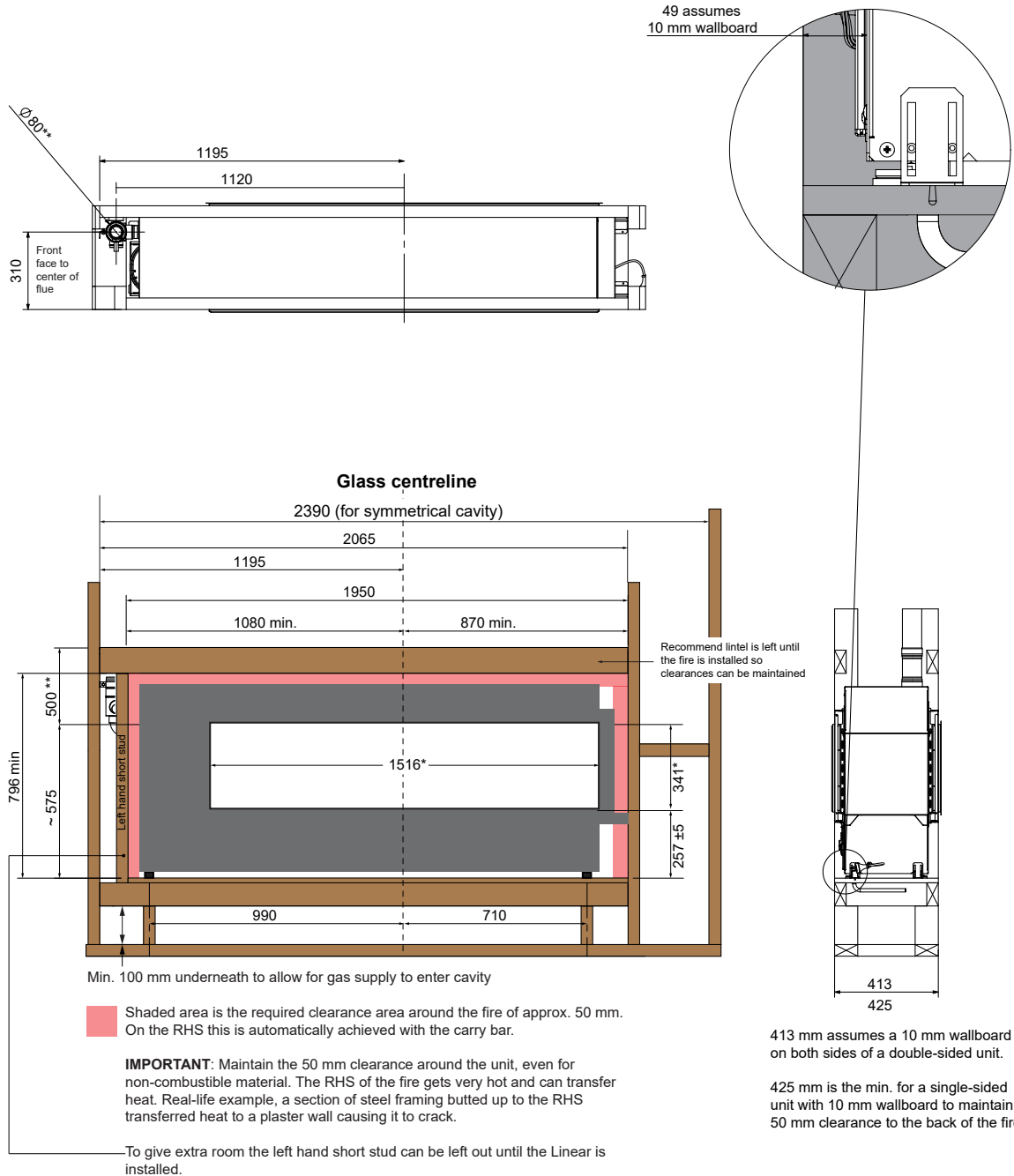

- * Minimum wallboard cutout if using the outer finishing trim
- ** Maintain 25 mm clearance to combustibles for the first 500 mm of flue

- All dimensions are assuming a 10 mm wallboard
- Studs and joists are required directly below the support feet of the fire
- Framing shown is 90 x 45 mm
- Fire platform shown is 18 mm plywood

Linear Indoor-Outdoor critical dimensions (mm)

Use the below information in conjunction with the framing dimensions on the previous pages.

For a successful installation it's important that the proposed window placement is checked to make sure the fire will fit. For example, enough room underneath for the Linear to be installed, and just as important, that the Linear fire won't be installed too high up the wall. The fire needs to be sized to match the window height. For the window dimensions refer next page.

The Linear 800 window opens sideways, left or right. The Linear 1000 / 1500 window opens downwards.

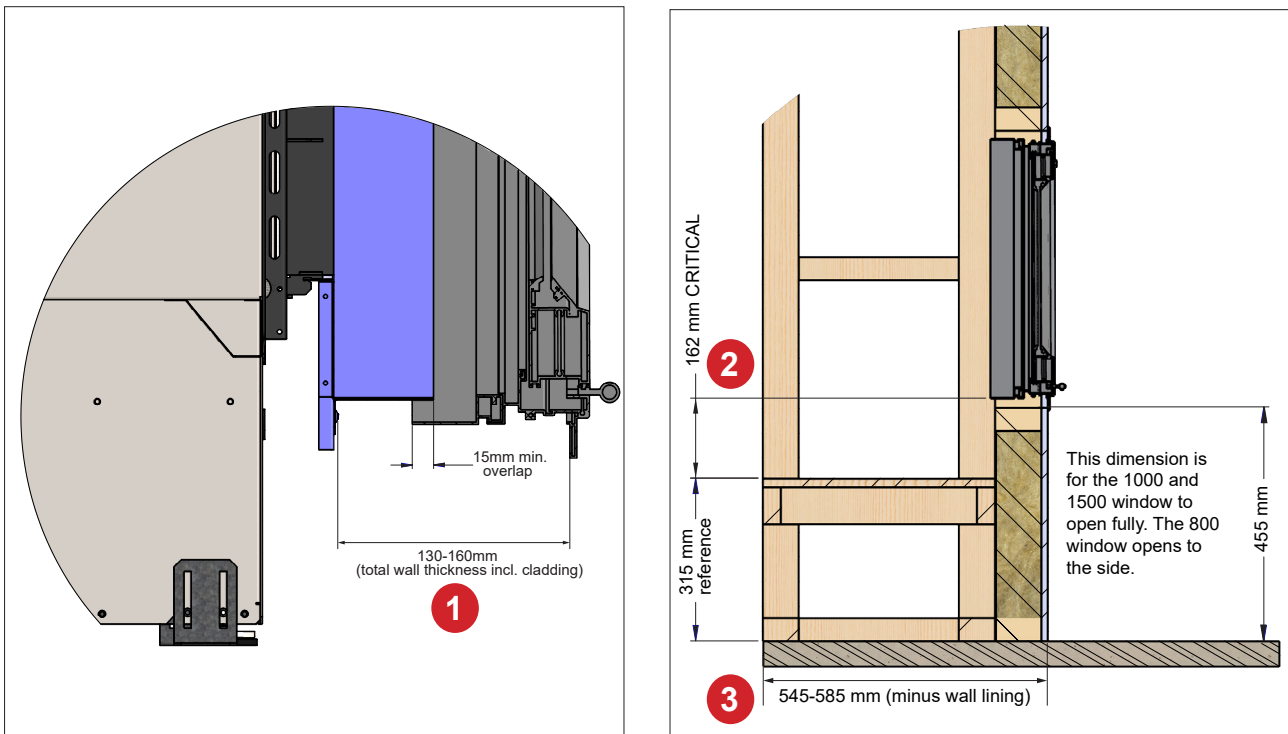

A plinth is constructed to position the fire in front of the outdoor window. This ensures the front lip of the fire is in line with the window lip, and ensures a complete view of the fire from the outside.

The critical dimensions for a successful and aligned installation are numbered 1, 2, and 3 on the diagrams. The 162 mm dimension (number 2) is to the window sill—packing and/or feet adjustment may be required.

While the 455 mm height allows for the window to be fully open (1000 and 1500 models), it may be too high for the preferred viewing position of the fire. Adjust as required.

Linear Indoor-Outdoor window dimensions (mm)

800 window

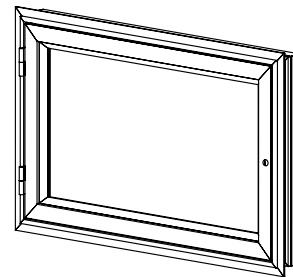
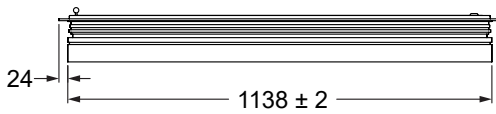
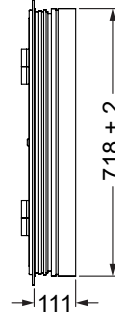
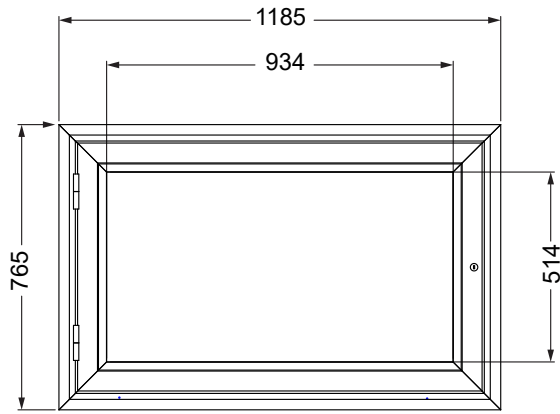

1000 window

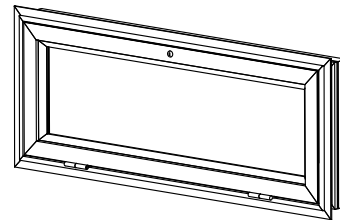
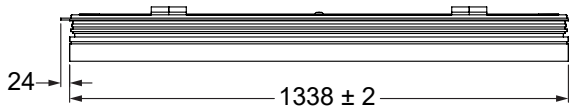
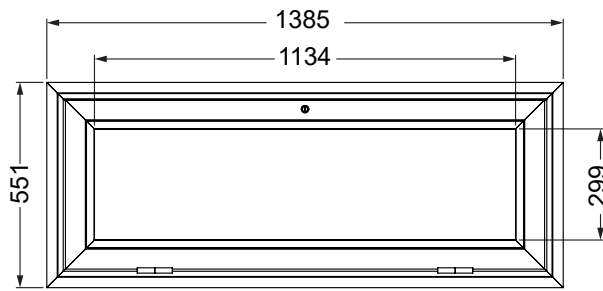

1500 window

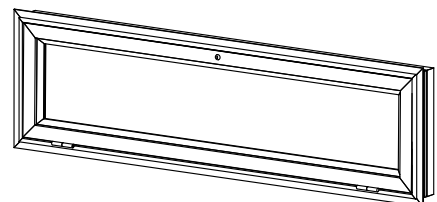
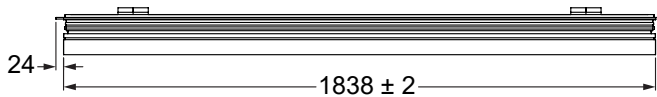
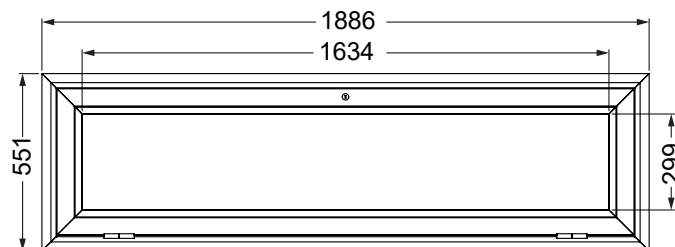

Linear Collection burn media



There is no part number for the 800 / 1000 FlameTech log set as the burn media is included with the fire.



800 FlameTech log set



1000 FlameTech log set

Utilising innovative log technology, flames emanate from the logs giving a more realistic flame picture.



R2902: 1000 designer log set

Mimicking natural drift wood and beach stones (ordered separately).



R2904: 1000 modern media

Modern media in the form of reflective black crushed glass (ordered separately).



R2903: 1500 designer log set

Mimicking natural drift wood and beach stones (ordered separately).



R2905: 1500 modern media

Modern media in the form of reflective black crushed glass (ordered separately).

Linear Collection accessories

Linear outer finishing trims (black)

	15 mm THIN	50 mm WIDE
800	R2915 (840 x 590 mm)	R2960 (910 x 660 mm)
1000	R2916 (1040 x 365 mm)	R2961 (1110 x 435 mm)
1500	R2917 (1040 x 365 mm)	R2962 (1610 x 435 mm)

Installation of the Linear requires the wall lining to be installed flush with the lips of the appliance. With plasterboard a smooth flush finish can be problematic. The outer finishing trim accessory, powder coated black, is designed to help achieve a smooth edge finish without plastering against the fire, which your tradie plasterers will love you for. Not suitable for installations with a hearth.



Linear mesh guard (black)

- 800 R2912
- 1000 R2913
- 1500 R2914

Designed to protect against touching the hot surface of the glass. No fixing required, the mesh guard, via two top slots, sits over the glass frame tabs, with the lower section secured in the same channel that holds the glass front.

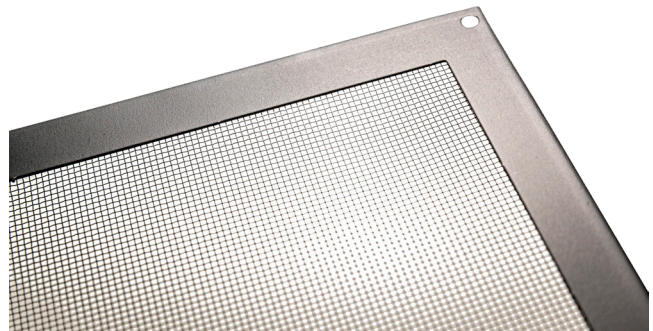

The mesh will still get very hot. If you are wanting to stop young hands from getting near the fireplace we would recommend a fire guard in front of the fire.

Pinecone accessory kit : R2906 (all models)

- Five pinecones

Elevate the aesthetics of your Rinnai fire by bringing the ambience of a woodland bonfire straight to your living room. Designed with meticulous attention to detail, these specially moulded ceramic pinecones (two small, two medium, and one large) look like just the real thing.

Ideally installed at the same time as the Linear as retrofitting will require a licensed gasfitter to install.



Linear black magic reflective side panels (two in a set)

- 800 R2910
- 1000 / 1500 R2911

Black glass reflector panels. Enhances the flame picture by producing a mirror image of the flames in the side panels. The images below show the Linear 1000 double-sided log set with the side panels installed, and the Linear 1000 double-sided modern media with the standard ceramic grooved side panels. Ideally installed at the same time as the Linear as retrofitting will require removing a number of internal components, which will add cost and time.



Linear peninsular pack (black)

- 800 R2924
- 1000 / 1500 R2925

A series of metal panels (1 mm thick) designed to fit around the fire to create a peninsular design on a double-sided model, as shown in the image below.

Each kit comes in three sections, two flat pieces and one folded endcap—powder coated black. We also have the ability to manufacture custom sizes, which are made to order, please contact Rinnai for more information.



Linear flueing options

For lowest cost, optimal performance, ease of installation and servicing, Rinnai recommend short flue installations (less than 3 m) are considered before all other options.

When considering the location of the fire care must be taken to ensure the flue path is free from obstructions such as studs, noggins, joists, braces, electrics etc.

Maximum flue length = 8.5 m Maximum number of bends = three

For every 90° bend, the overall length must be reduced by 1 m. For example, if an installation has three 90° bends, the maximum flue length can be 5.5 m. The elbow component of the Linear adaption flue kit (LSFKIT01) IS NOT counted as a 90° bend.

300 mm of straight flue before any bends

A minimum of 300 mm of straight flue is required before any bends. This is required due to the heat produced from the initial section of flue. The LSFKIT01 has the 300 mm minimum flue length built in.

If using the direct flue (ASPDFK) and connecting to any bends, a flue transition extension (LSFEXKIT01) must be connected to achieve the minimum length.

Side direct, sided extended, side and back flueing

Side direct through the wall flueing for walls up to 385 mm thick. Flue can be extended if the wall thickness is greater than 385 mm by using additional lengths of flue pipe, and the pipe can be directed behind by using the flue transition extension and bend kit.



1. Direct flue kit - ASPDFK

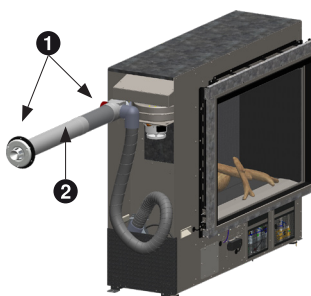

1. Direct flue kit - ASPDFK
2. Flue pipe - ESPIPE900

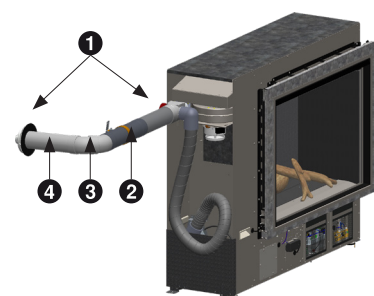

1. Direct flue kit - ASPDFK
2. Flue transition - LSFEXTKIT01
3. 45° bends - ESBEND
4. Flue pipe - ESPIPE900

Back direct and back extended flueing

By changing the direction of the adaption flue position and connection, back direct and back direct extended flueing is possible.

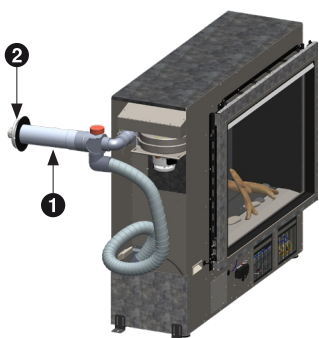

1. Adaption flue - LSFKIT01
2. Wall terminal - ESWTERM

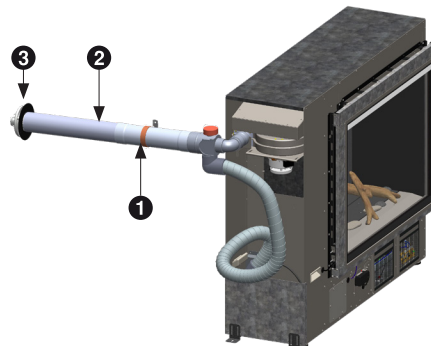

1. Adaption flue - LSFKIT01
2. Flue pipe - ESPIPE900
3. Wall terminal - ESWTERM

Up and back, and up and over flueing

Up and back through the wall flueing for walls up to 385 mm thick. Flue can be extended if the wall thickness is greater than 385 mm by using additional lengths of flue pipe.

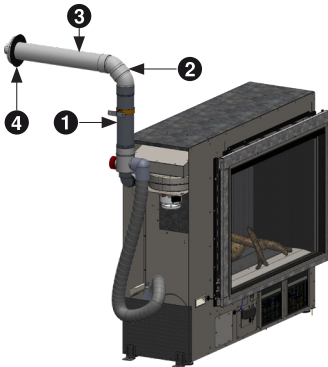

- 1. Adaption flue - LSFKIT01
- 2. 45° bends - ESBEND
- 3. Flue pipe - ESPIPE900
- 4. Wall terminal - ESWTERM

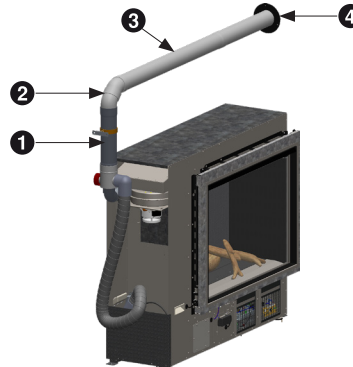

- 1. Adaption flue - LSFKIT01
- 2. 45° bends - ESBEND
- 3. Flue pipe - ESPIPE900 x 2
- 4. Wall terminal - ESWTERM

Down and out flueing

The down and out flue allows for the adaption flue to face downwards, and for the flue to run vertically through a hole in the floor, and then to terminate horizontally outside.

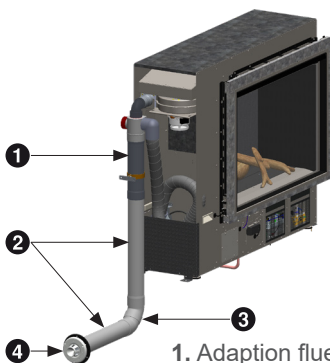

- 1. Adaption flue - LSFKIT01
- 2. Flue pipe - ESPIPE900 x 2
- 3. 45° bends - ESBEND
- 4. Wall terminal - ESWTERM
- 5. Wall plate - ESPLATE (not shown)

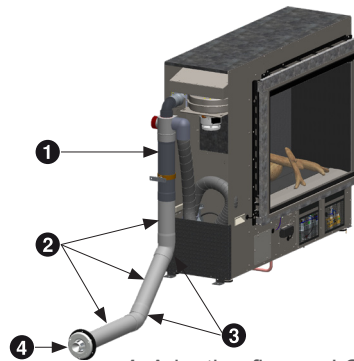

- 1. Adaption flue - LSFKIT01
- 2. Flue pipe - ESPIPE900 x 3
- 3. 45° bends - ESBEND
- 4. Wall terminal - ESWTERM
- 5. Wall plate - ESPLATE (not shown)

Vertical flueing

The vertical in-wall flue installation is installed against an internal wall or other suitable cavity, and is run vertically upwards to a vertical termination above the roof.

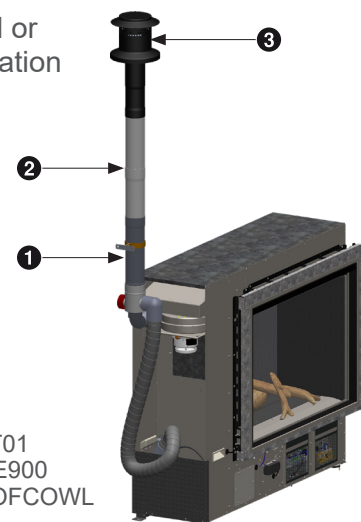

- 1. Adaption flue - LSFKIT01
- 2. Flue pipe - ESPIPE900
- 3. Vertical terminal - ESROOFCOWL

Linear flue components

Due to heat from the flue components, maintain 25 mm clearance to combustibles for the first 500 mm of flue

Direct flue kit - ASPDFK (aluminium)

Suitable for walls up to 385 mm thick (can be cut to length). Can also be used with ESPIPE900 for longer flueing. The minimum length when measured from the back plate of the transition casting MUST NOT be less than 300 mm when joining to other components.

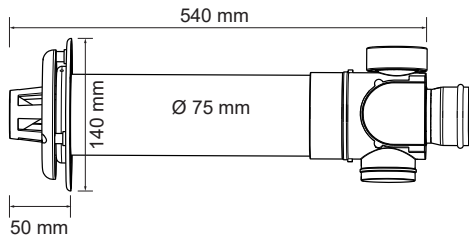

Not pictured is the internal white wall plate

Adaption flue kit - LSFKIT01

Includes flue adaptor, flue extension, standoff bracket, flue slide stopper (4822), O-ring silicone grease.

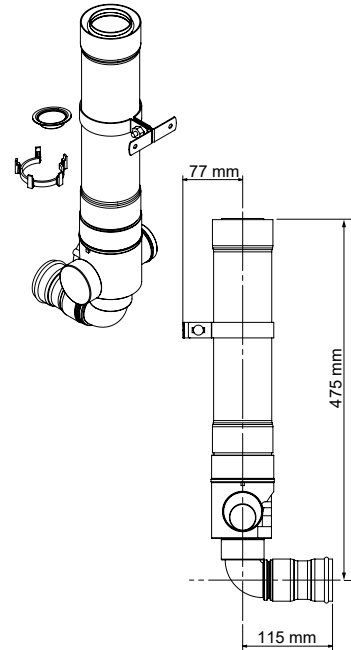

45° flue bends - ESBEND

Two bends in a kit. Can be used separately, or together as a 90° bend.

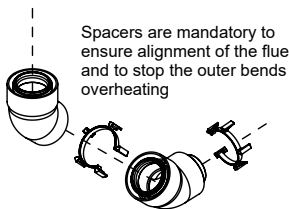

Spacers are mandatory to ensure alignment of the flue and to stop the outer bends overheating

Wall terminal kit - ESWTERM

Used to terminate the ESPIPE900 in horizontal flue installations when used with LSFKIT01.

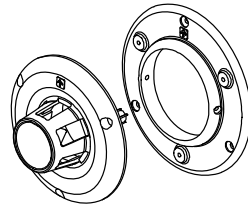

Flue pipe - ESPIPE900

Extension pipe used for horizontal, vertical, and downwards flueing. Can be cut to size at the non-socketed end.

Inner is aluminium, outer white PVC. Comes with a wall bracket, o-ring (4350), and spacer (4351).

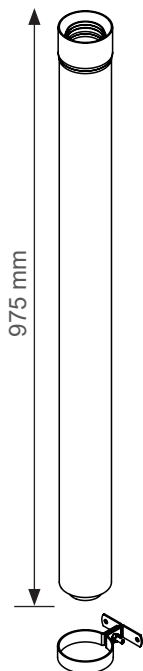

Roof terminal - ESROOFCOWL

Roof cowl and connecting pipe for termination of a vertical flue—can be cut to size. 500 mm clearance required from any part of the building.

Galvanised steel, powder coated black.

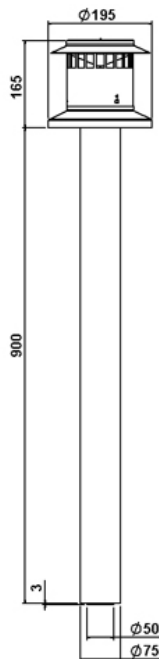

Transition extension - LSFEXTKIT01

Flue transition extension, MUST BE used with the ASPDFK before any bends, for example in side and back flueing. When connected overall length reduces 45 mm each end.

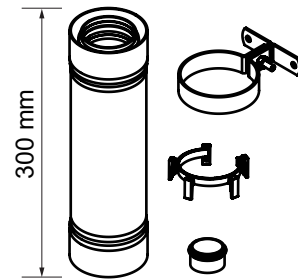

Wall plate - ESPLATE

Used in down and out flueing to cover the floor penetration, and also as an extra wall cover if required, to tidy up an installation. Outer diameter 170 mm.

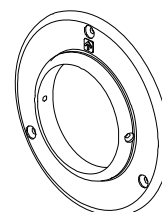

Direct flue kit - ASPDFK

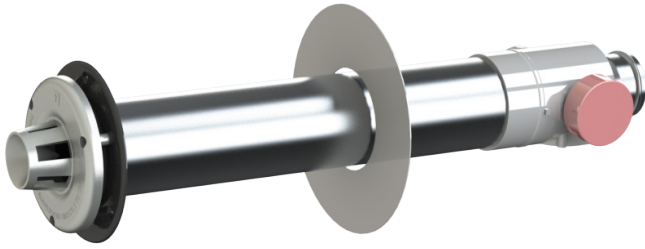

Adaption flue kit - LSFKIT01



45 ° flue bends - ESBEND



Flue pipe - ESPIPE900



Roof terminal - ESROOFCOWL



Transition extension - LSFEXTKIT01





Wall terminal kit - ESWTERM







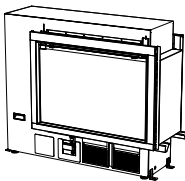
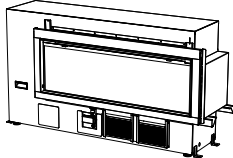
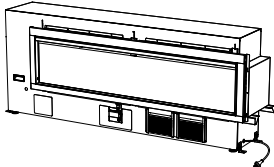

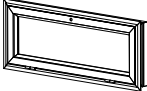



Wall plate - ESPLATE

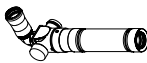
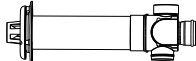
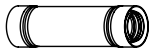

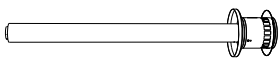
Linear ordering guide

1	Decide on which Linear model, single or double side, and gas type.			
		Model	Code	RRP
		Linear 800 FlameTech single side NG	RHFE0800SF1N	\$10,999
		Linear 800 FlameTech single side LPG	RHFE0800SF1L	\$10,999
		Linear 800 FlameTech double side NG	RHFE0800DF1N	\$11,999
		Linear 800 FlameTech double side LPG	RHFE0800DF1L	\$11,999
		Linear 800 FlameTech indoor-outdoor NG	RHFE0800WF1N	\$12,161
		Linear 800 FlameTech indoor-outdoor LPG	RHFE0800WF1L	\$12,161
		Linear 1000 single side NG	RHFE1000S1N	\$8,990
		Linear 1000 single side LPG	RHFE1000S1L	\$8,990
		Linear 1000 double side NG	RHFE1000D1N	\$9,990
		Linear 1000 double side LPG	RHFE1000D1L	\$9,990
		Linear 1000 FlameTech single side NG	RHFE1000SF1N	\$10,999
		Linear 1000 FlameTech single side LPG	RHFE1000SF1L	\$10,999
		Linear 1000 FlameTech double side NG	RHFE1000DF1N	\$11,999
		Linear 1000 FlameTech double side LPG	RHFE1000DF1L	\$11,999
		Linear 1000 FlameTech indoor-outdoor NG	RHFE1000WF1N	\$12,161
		Linear 1000 FlameTech indoor-outdoor LPG	RHFE1000WF1L	\$12,161
		Linear 1000 indoor-outdoor NG	RHFE1000W1N	\$10,045
		Linear 1000 indoor-outdoor LPG	RHFE1000W1L	\$10,045
			Linear 1500 single side NG	RHFE1500S1N
Linear 1500 single side LPG			RHFE1500S1L	\$10,999
Linear 1500 double side NG	RHFE1500D1N		\$11,999	
Linear 1500 double side LPG	RHFE1500D1L		\$11,999	
Linear 1500 indoor-outdoor NG	RHFE1500W1N		\$10,730	
Linear 1500 indoor-outdoor LPG	RHFE1500W1L		\$10,730	
2	If ordering a Linear 1000 (except FlameTech model) or 1500, decide on the burn media, either designer log set or modern media (crushed glass).			
		1000 and 1500 burn media	Code	RRP
		Linear 1000 designer log set	R2902	\$1,009
		Linear 1500 designer log set	R2903	\$1,235
		Linear 1000 modern media	R2904	\$1,009
		Linear 1500 modern media	R2905	\$1,235
3	If ordering a Linear indoor-outdoor model, order the corresponding window kit. The window kit contains the double glazed black aluminium window.			
		Window kit	Code	RRP
		Linear 800 indoor-outdoor window kit	R2930	\$1,967
		Linear 1000 indoor-outdoor window kit	R2940	\$2,082
Linear 1500 indoor-outdoor window kit		R2950	\$2,177	

4 Decide on optional accessories			
	Accessory	Code	RRP
	Linear 800 outer finishing trim 15 mm THIN	R2915	\$287
	Linear 800 outer finishing trim 50 mm WIDE	R2960	\$347
	Linear 1000 outer finishing trim 15 mm THIN	R2916	\$267
	Linear 1000 outer finishing trim 50 mm WIDE	R2961	\$327
	Linear 1500 outer finishing trim 15 mm THIN	R2917	\$374
	Linear 1500 outer finishing trim 50 mm WIDE	R2962	\$434
	Linear 800 mesh guard	R2912	\$460
	Linear 1000 mesh guard	R2913	\$458
	Linear 1500 mesh guard	R2914	\$573
	Linear 800 black magic reflective side panels	R2910	\$683
	Linear 1000 black magic reflective side panels	R2911	\$415
	Linear 1500 black magic reflective side panels	R2911	\$415
	Linear 800 peninsular pack	R2924	\$472
	Linear 1000 / 1500 peninsular pack	R2925	\$520
	Pinecone accessory kit	R2906	TBA
5 Decide on flue configuration and select flue components			
	Flue component	Code	RRP
	Adaption flue kit	LSFKIT01	\$503
	Direct flue kit	ASPDFK	\$282
	Flue transition extension	LSFEXTKIT01	\$148
	Coaxial flue pipe 900 mm	ESPIPE900	\$116
	Vertical terminal	ESROOFCOWL	\$284
	45° flue bends (two in a kit)	ESBEND	\$151
	Wall terminal	ESWTERM	\$204
	Wall plate	ESPLATE	\$32

Please note

RRP pricing is accurate at the time of print. It has been provided as we receive daily enquiries from customers regarding indicative costs. For up-to-date pricing, please visit our website, www.rinnai.co.nz.

Running costs

Cost assumptions and calculations

It's becoming a competitive market out there and we're noticing that plans and pricing is difficult to access and compare. We've based the running costs on the below information. As the cost of LPG and Natural Gas will differ in each area, please check with your local supplier.

Natural gas as at October 2023

- Mercury Energy c/kWh - 9.91cents (exc. GST), 11.40 cents (incl. GST)
- Mercury Energy fixed daily line charge - \$1.61 (includes GST), \$11.27 per week

LPG as at October 2023

To fill a 45 kg gas bottle we found the below numbers published online. We used the Genesis Energy figure as the average cost for calculating the running costs.

- Frank Energy LPG bottle refill \$140 (includes GST)
- Vector Ongas \$132.52-\$205.82 (includes GST)
- Genesis Energy \$150.48 (includes GST)

45 kg LPG gas bottle energy calculation

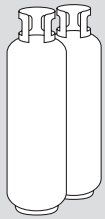

1 kg of LPG gas contains 50.4 MJ of energy
1 kW = 3.6 MJ

This means that a 45 kg LPG bottle has approximately 2268 MJ (45 kg x 50.4 MJ)

Natural Gas: Calculating running costs

1. Convert the MJ input of the appliance to kW, for example 15 MJ/h = 4.17 kW/h
2. Calculate the approximate running cost per hour, for example $0.1140 \times 4.17 \text{ kW/h} = \$0.48/\text{hr}$

LPG: Calculating running costs

1. Calculate the cost of gas per MJ/h, for example $\$150.48 \div 2268 \text{ MJ} = \0.07 per MJ/h
2. Calculate the approximate running cost per hour, for example $\$0.07 \times 15 \text{ MJ/h} = \$1.05 / \text{hr}$

Linear running cost calculations

Hourly running costs

Model	Heating area	LPG running costs per hr.		NG running costs per hr.	
		on low	on high	on low	on high
Linear 800	71-123 m ²	\$1.05	\$2.45	\$0.48	\$1.11
Linear 1000	69-118 m ²	\$1.05	\$2.38	\$0.48	\$1.07
Linear 1500	79-135 m ²	\$0.98	\$2.80	\$0.44	\$1.27

Please note

The heat output and heating areas will differ slightly for the single sided and double sided variants. Single sided models will be slightly more efficient.

45 kg LPG bottle and weekly running costs

Model	Gas input				45 kg bottle will last (hours)		Weekly running costs (\$)			
	Low		High		Low	High	LPG		Natural Gas*	
	MJ/h	kW	MJ/h	kW			Low	High	Low	High
Linear 800	15	4.17	35	9.72	151	65	\$36.75	\$85.75	\$28.07	\$50.12
Linear 1000	15	4.17	34	9.44	151	67	\$36.75	\$83.30	\$28.07	\$48.72
Linear 1500	14	3.89	40	11.11	162	57	\$34.50	\$98.00	\$26.67	\$55.72

* The NG weekly costs include the \$1.61 daily fixed line charge

The running costs values are meant as a guide only. Please refer to the notes regarding running cost assumptions and how values have been calculated on the previous page. Always double check figures based on your own use.

The weekly running costs are calculated based on the gas fire, during cooler months, operating two hours in the morning and three hours in the evening—a total of five hours use each day.

Please note

All Rinnai gas fires require electricity to run—electricity costs have not been factored into the running costs.

The 45 kg LPG bottle hours do not include running times of other gas appliances in use, for example a gas water heater or a gas hob.

Rinnai.co.nz

Tel: 0800 746 624

<http://www.youtube.com/rinnainz>

<http://facebook/com.rinnainz>