

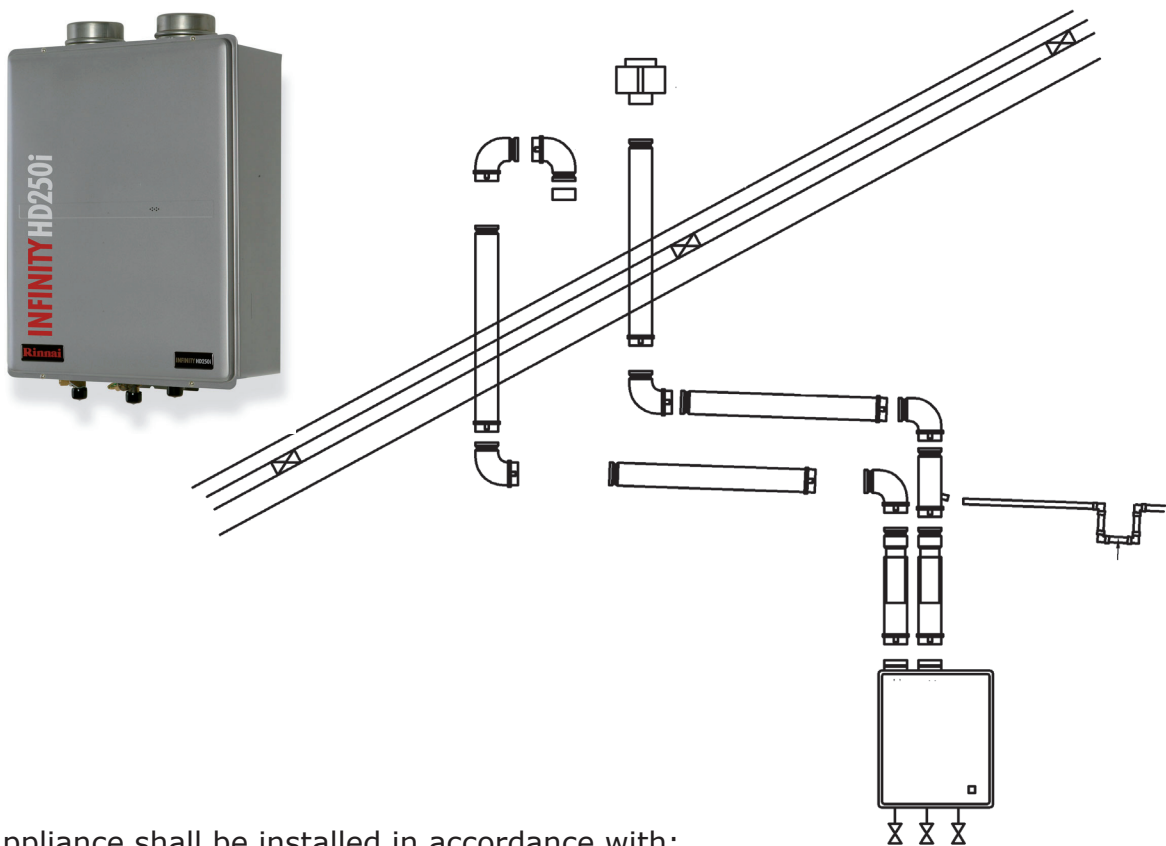

# HD250i Horizontal, Vertical and Combination Flueing

## Installation Manual



This appliance shall be installed in accordance with:

- Manufacturer's Installation Instructions
- Local Gas Fitting Regulations
- NZS 5261 Installation Code
- Municipal Building Codes
- Any other local relevant statutory regulation

Installation and service must be performed by an authorised person.

# Table of Contents

---

General Information.....	3
Horizontal Installations.....	4
Vertically Terminated Installations.....	5
Air Intake Assembly.....	6
HD250i Combination Flue Components .....	6
Customer Contacts .....	8

The HD250i comes factory set to 75 °C. When using in domestic applications this temperature needs to change to 55 °C by changing the dip switch as follows.

**Dip switch 3,4 and 5 (bank 1) for temperature settings**

Off	On
<input checked="" type="checkbox"/>	<input type="checkbox"/>
<input checked="" type="checkbox"/>	<input type="checkbox"/>
<input checked="" type="checkbox"/>	<input type="checkbox"/>

Rinnai will accept no liability for issues arising out of the use of the DIP switch information. Please use this information carefully and fully check the operation of the water heater before leaving site including the temperature of the water delivered.

## **WARNING**

Improper installation, adjustment, alteration, service or maintenance can cause property damage, personal injury or loss of life. For assistance or additional information consult an authorised person or Rinnai on 0800 RINNAI (0800 746 624).

Installation and service must be performed by an authorised person.

# General Information

---

**Before Installation** Inspect each flue component for damage. Do not attempt to fix or install any damaged components.

**Existing Flue or Chimney** Do not connect with any existing flue or chimney. Do not connect with the flue pipe of any other water heater or appliance.

**Ensure HD250i Can Be Easily Removed** For servicing, repair or replacement, ensure the Rinnai HD250i can be removed without causing damage to the installation. This can be achieved by using an adjustable flue component (FFHD250PIPEADJ) as the first section on top of the appliance.

**Other Supplier Flue Components Can Not Be Substituted** The Rinnai HD250i is a direct flue water heater and is only certified and listed with Rinnai flue components (excluding air inlet and protective mesh). Do not combine or use flue components from other manufacturers. Only the flue components identified in this installation manual are to be used for horizontal, vertical and combination flueing.

**Clearance for Exhaust Flue Components** The exhaust flue components are single skin and need to maintain a 25mm clearance from combustibles as per NZS 5261:2003 2.6.12.11.

**Flue Must Be Supported** Flue must be supported and be independent of the appliance.

**Flue Terminal Clearances** Ensure positioning of the flue terminal and flue installation comply with NZS 5261:2003, 'Table 16 - Minimum clearances required for flue terminals shown in figure 3'.

**Connecting Flue Components** Flue connections must be firmly pressed together so that the gaskets form an air tight seal.

**Maximum Flue Length and Number of 90° Bends**

Number of 90° Bends	Maximum Flue Length	Dip Switch Setting*
0	12.5m	If the length is < 6.5m then move the dip switch no. (SW1) to ON
1	10.5m	If the length is < 5.0m then move the dip switch no. (SW1) to ON
2	8.5m	If the length is < 3.0m then move the dip switch no. (SW1) to ON
3	7.0m	-
4	5.0m	-
5	3.5m	-
6	1.5m	-

\* Duct resistance varies with flue length so dip switch settings need to be adjusted to vary the fan speed.

**Not to be Confused with Direct Flueing** Components for this Rinnai flueing application cannot be interchanged with the Rinnai Direct Flueing solution. Direct flueing is for installations where the HD250 Internal is mounted directly on the inside of an external wall (cannot be extended).

# Horizontal Installations

## Horizontal Installation with Rinnai Flueing Components

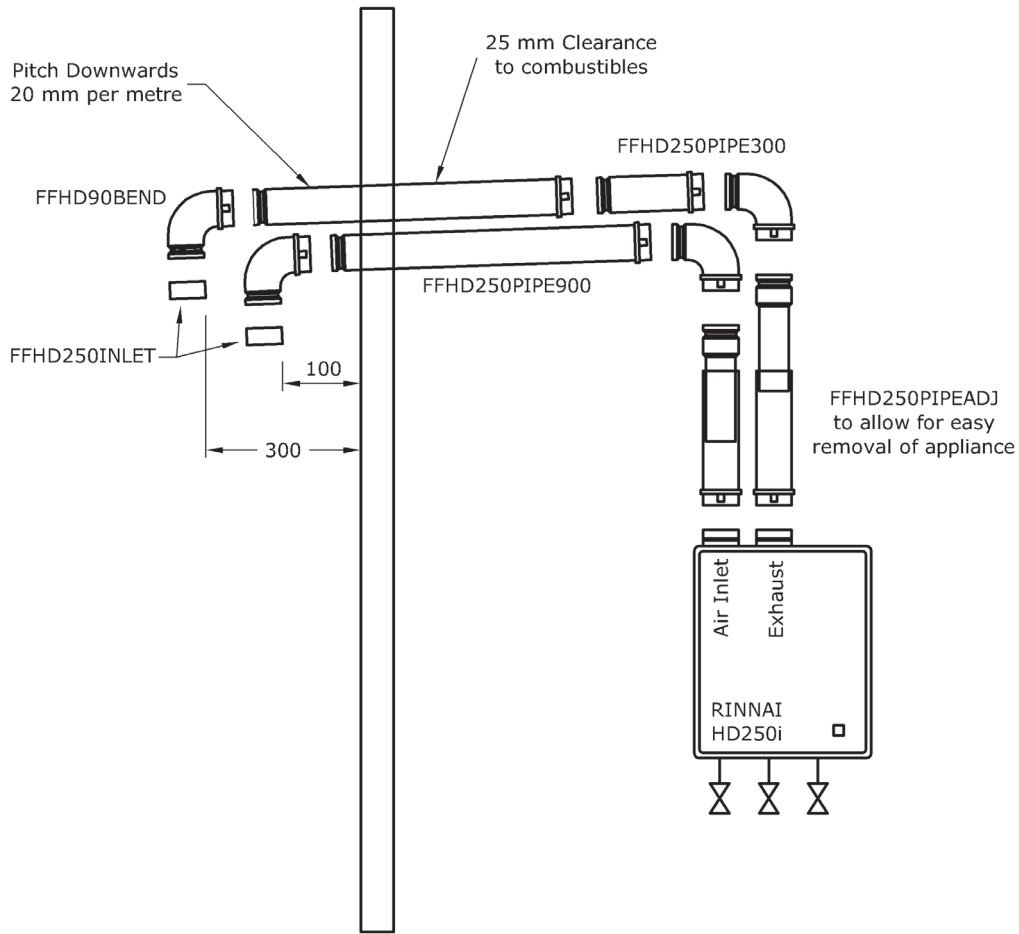

**Air Intake/Exhaust** Each requires a 90° bend to prevent entry of rain.

**Exhaust/Intake Relationship** Intake must be located in relation to the exhaust as shown below.

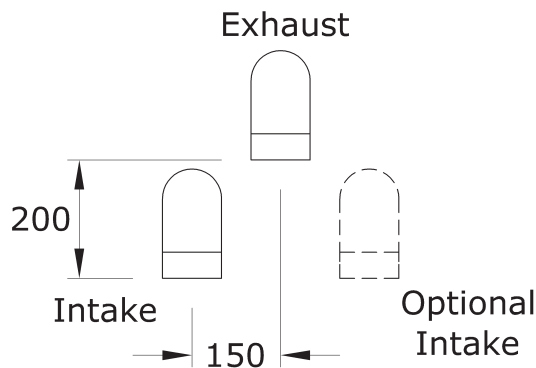

**Condensate** Horizontal flues must slop 20mm per metre to the termination point. Ensure condensate drains appropriately. This is particularly relevant to longer horizontal runs where more condensate is produced.

# Vertically Terminated Installations

## Vertical/Combination Installation with Rinnai Flueing Components

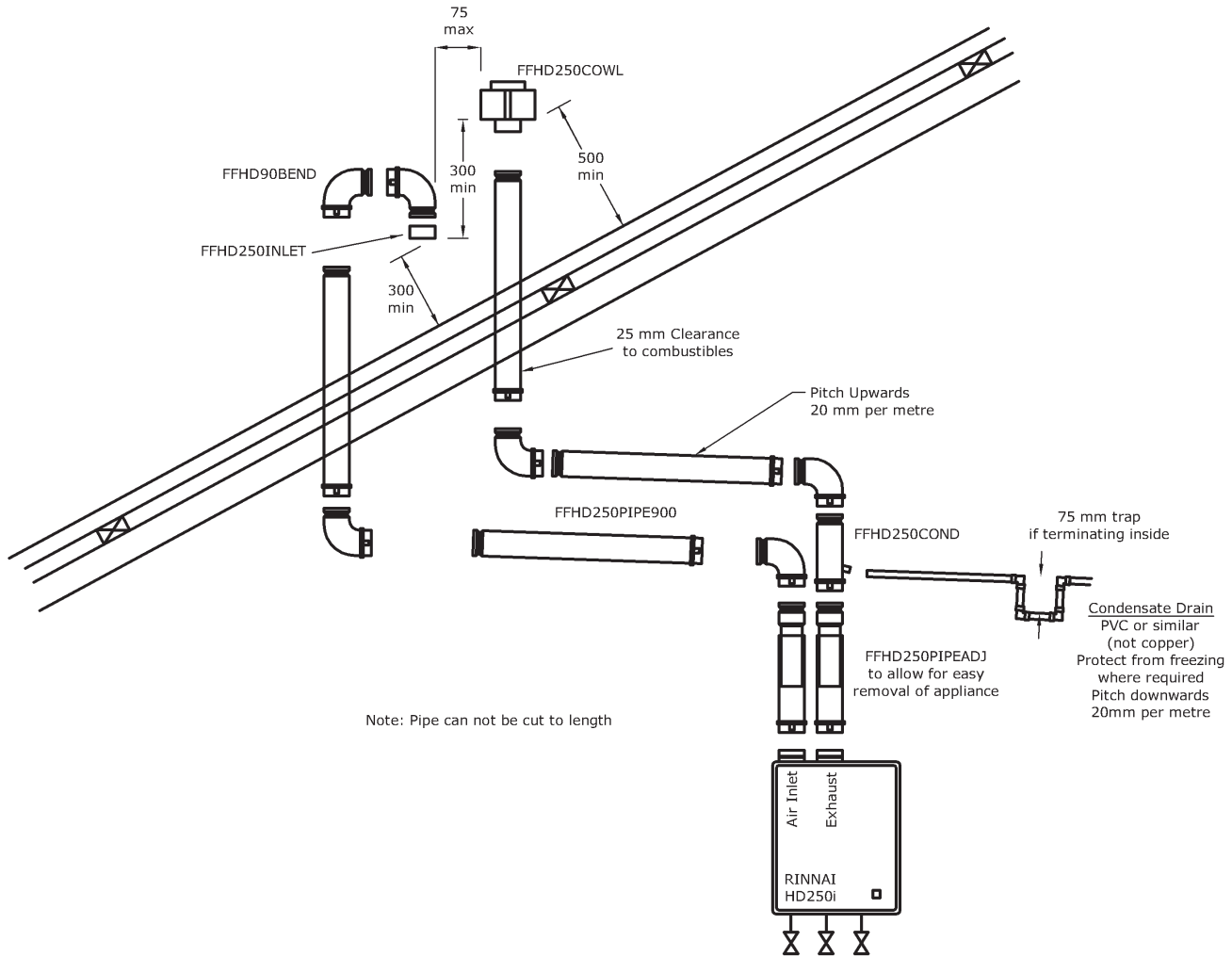

**Air Intake** Requires two 90° bends to prevent entry of rain.

**Condensate** Vertical terminations must incorporate a condensate drain and trap as close as possible to the appliance.

Condensate drain trap must contain a minimum of 75mm.

**Roof Cowl Clearance** 500mm clearance shown is for simple roof pitches. Complex multiple pitched roofing can interfere with correct flueing of the appliance and greater clearances to flue terminals may be required. Please contact Rinnai Specification Service for further information.

# Air Intake Assembly

---

Air for combustion is supplied directly from outside so the intake is not exposed to high temperatures.

The intake can either be the Rinnai HD250i flue components or a suitable 100mm ABS or CPVC plastic pipe supplied by the installer. It is important to maintain clearance to the hot exhaust flue to avoid the plastic from melting.

The air inlet requires a mesh supplied by the installer to be fitted to prevent entry of foreign material. This should be approximately 15 mm in diameter.

## Air Intake Configuration

1. Pre-drill two small holes at the end of the air intake pipe.

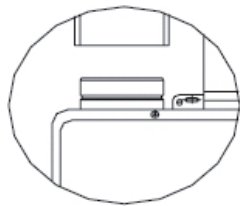

2. Slide the pipe over the air intake terminal.

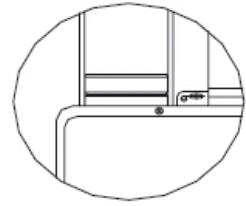

3. With self tapping screws, attach the pipe to the air intake terminal.

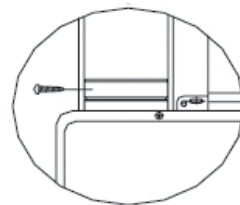

4. Apply a bead of silicone around the pipe to the air intake terminal, ensuring an air tight connection.

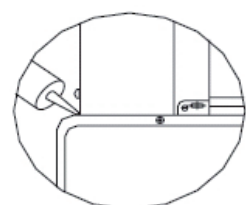

# HD250i Combination Flue Components

---

All Rinnai HD250i Combination Flueing components:

- Have an outside diameter of 100 mm, all measurements are in mm unless otherwise stated
- Are made of stainless steel and can not be cut to size
- Are single skin and need to maintain a 25 mm clearance from combustibles

Do not fix connections or sliding joints with adhesive tape.

---

## **FFHD250COND**      **HD250i Condensate Trap**

Condensate trap for vertical installations. Should be installed as close as possible to the appliance.

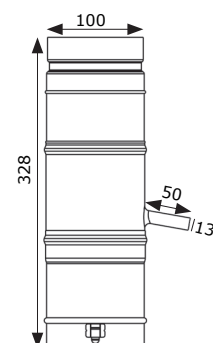

# HD250i Combination Flue Components

## FFHD250INLET HD250i Air Inlet

Air inlet required on all installations, mesh included.



## FFHD250COWL HD250i Vertical Roof Termination Cowl

Stainless steel roof cowl used to terminate vertical installations.

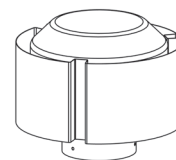

## FFHD250BEND90 HD250i Flue 90° Bend

Stainless steel 90° bend used to facilitate between horizontal and vertical flueing. Maximum of three 90° bends can be used.

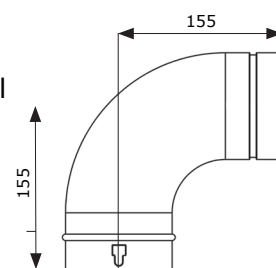

## FFHD250BEND45 HD250i Flue 45° Bend

Stainless steel 45° bend used to offset obstructions.

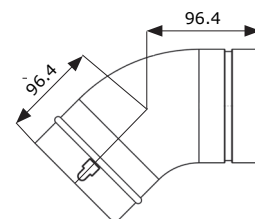

## FFHD250PIPE300 HD250i Flue Pipe 300mm

Stainless steel 300mm stainless steel pipe, can not be cut to size.

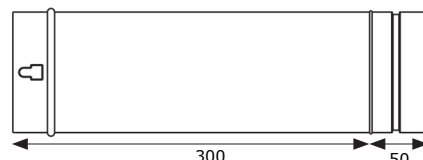

## FFHD250PIPE900 HD250i Flue Pipe 900mm

Stainless steel 900mm stainless steel pipe, can not be cut to size.

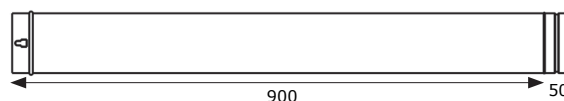

## FFHD250PIPEADJ HD250i Flue Adjustable Length

Stainless steel adjustable flue pipe recommended for use as the first flueing component off the Infinity unit for both the air intake and exhaust flue. Pipe can not be cut to length.

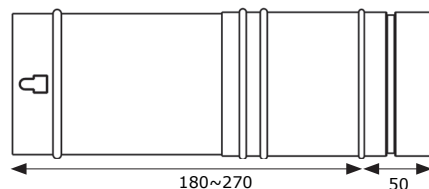

**To Connect the Flue Components** Connect the pre-greased components. Ensure the O-Rings are not damaged during this process. Ensure the flue is locked in position.

**To Disconnect the Flue Components** Push the components tightly together and press the small locking tab. While holding the small tab in, gently slide the components apart. Ensure the O-Rings are not damaged during this process.

# Customer Contacts

---

For more information about Rinnai appliances call:

- Consumers 0800 RINNAI (0800 746 624)
- Installers 0800 TO RINNAI (0800 86 746 624)

## Rinnai New Zealand Limited

105 Pavilion Drive  
Airport Oaks PO Box 53177  
Mangere Auckland Airport  
Manukau Manukau 2150

Phone: (09) 257 3800  
Fax: (09) 257 3899

Email: [info@rinnai.co.nz](mailto:info@rinnai.co.nz)  
Website: [www.rinnai.co.nz](http://www.rinnai.co.nz)

All Rinnai appliances meet or exceed the safety standards required by New Zealand gas and electrical regulations.

Rinnai is constantly improving its products and as such specifications are subject to change or variation without notice.

# Rinnai

## HD250i Horizontal, Vertical and Combination Flueing Installation Manual

Instructions Part Number: 11180

Issue: A