

Rinnai

CONVECTOR 229H

Unflued Room Heater

CUSTOMERS OPERATING INFORMATION AND INSTALLATION INSTRUCTIONS

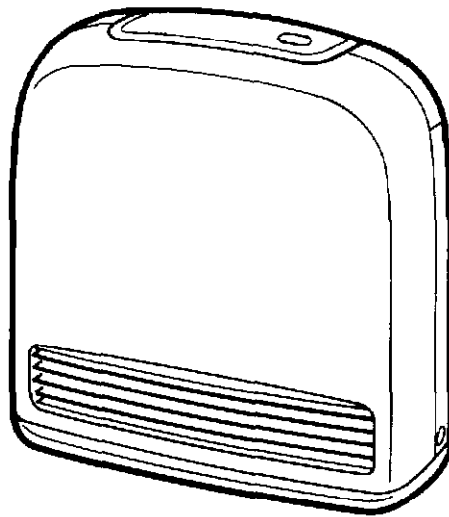

This appliance shall be installed in accordance with :

- Manufacturer's Installation Instructions
- Local Authority Building Codes
- NZS 5261 Installation Code for Gas Burning Equipment
- Any other relevant Statutory Regulation

This appliance must be installed, serviced and removed by an authorised person.

RINNAI GUARANTEE OF QUALITY

DEAR CUSTOMER

THANK YOU FOR PURCHASING THIS RINNAI APPLIANCE. WE ARE PLEASED TO ADVISE THAT RINNAI PRODUCTS ARE NOW COVERED BY A 2 YEAR. GUARNTEE FREE PARTS AND LABOUR FOR THE FIRST YEAR AND PARTS ONLY FOR THE SECOND YEAR.

-THIS GUARANTEE IS IN ADDITION TO ANY GUARANTEES WHICH CONSUMERS MAY HAVE UNDER THE CONSUMER GUARANTEES ACT- SHOULD YOU HAVE ANY QUERIES REGARDING THIS GUARANTEE PLEASE CONTACT YOUR LOCAL RINNAI AGENT.

The benefits conferred by this guarantee are in addition to all other rights and remedies in respect of the product which you have under the Trade Practices Act and other State and Territory Laws.

The heater must be installed correctly, and the installation must conform to all local regulations.

The installation must also comply with the instructions supplied by Rinnai.

The heater must be serviced by an authorised person.

No parts or functions should be modified or permanently removed from the heater.

Please Note: general cleaning, maintenance and wear and tear are not necessarily covered by the guarantee. Calls of this nature may be chargeable.

Your Rinnai Convactor has been approved by the Australian Gas Association.
A.G.A. Approval Number : 5631

Please keep these instructions in a safe place for future reference.

Please record below:

Your Retailer:

NAME _____

ADDRESS _____

TELEPHONE _____

Date of Purchase:

ABOUT YOUR NEW CONVECTOR 229H

FRONT

LOUVRE
Warm air discharge duct.

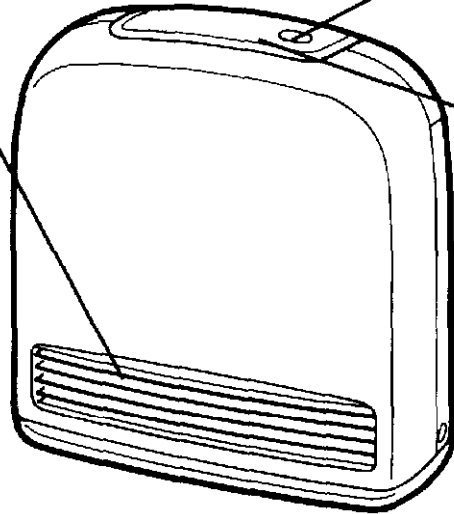

ON/OFF SWITCH

CONTROL PANEL
Panel with room and pre-set temperature selection. Appliance error codes are shown here.

REAR

Gas Inlet

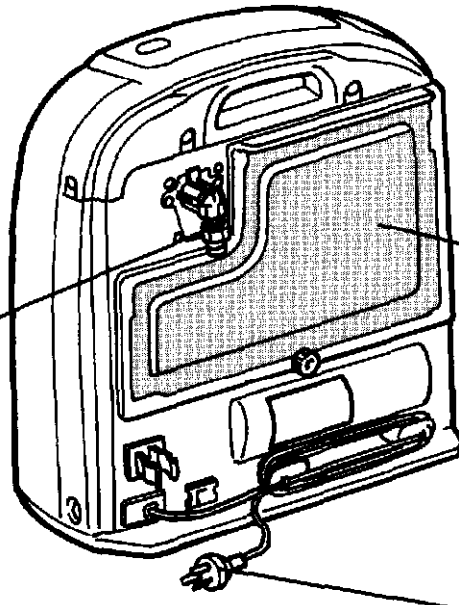

Air Filter-1

Power Cord

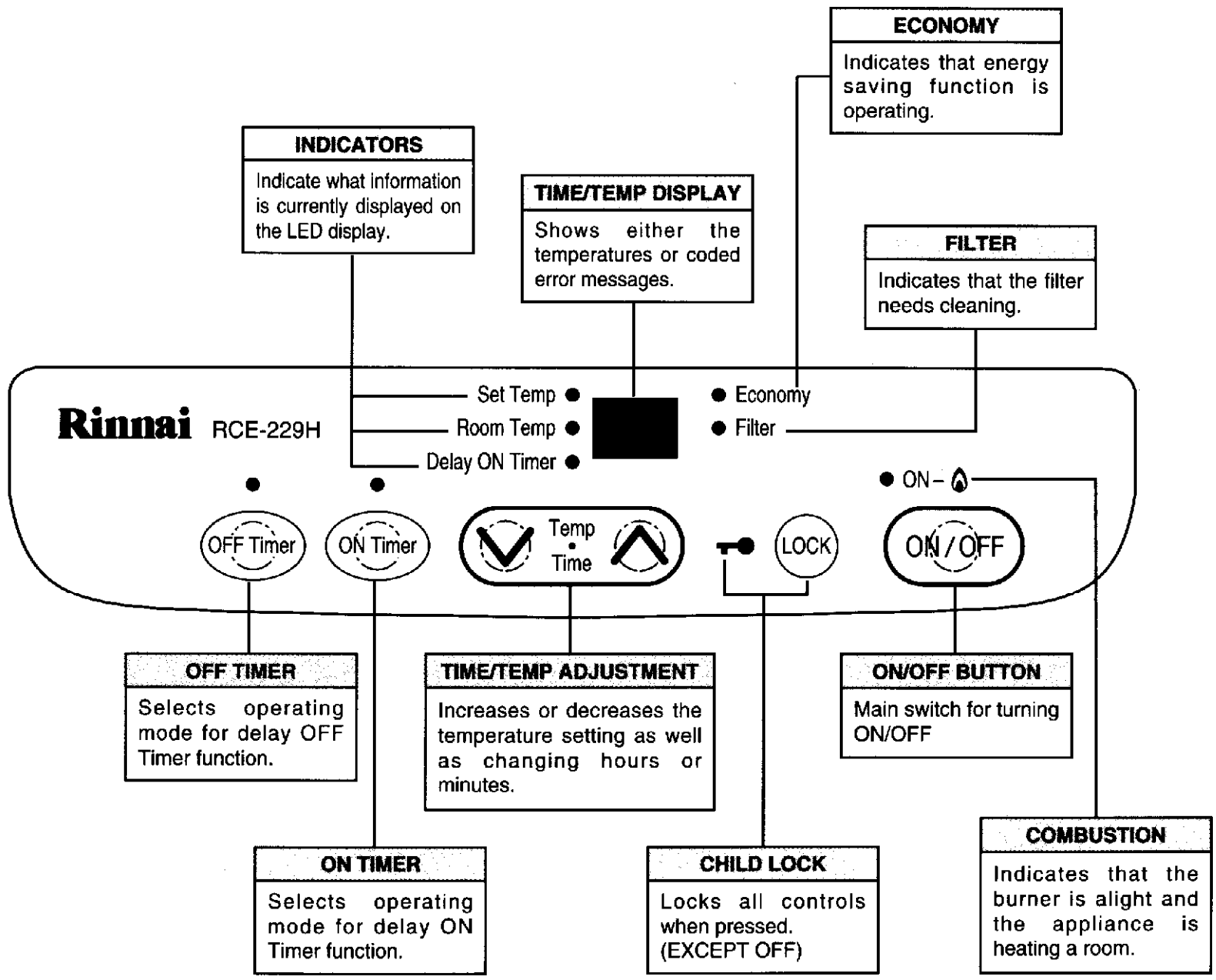

FEATURES

PUSH BUTTON IGNITION

Only one touch of the ON/OFF switch is required to operate the heater.

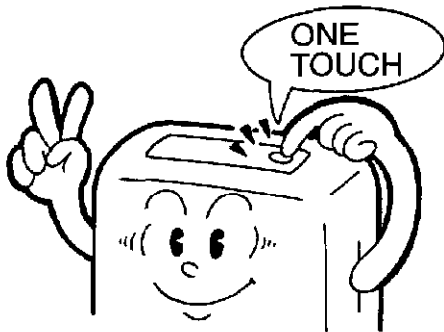

CHILD LOCK

When the Child lock is activated all controls other than the OFF switch will be locked.

Deactivating the lock releases the controls. If the lock is activated when the appliance is off, all functions will be locked.

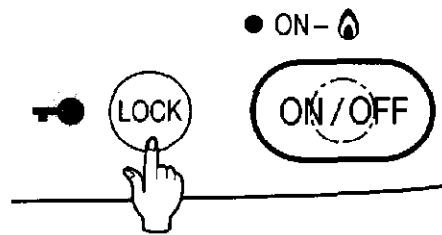

MEMORY

The micro-computer records selected preset temperatures, the time selected into ON Timer as well as operating the Economy and OFF Timer modes, to maintain comfort levels.

OFF TIMER

This feature allows you to programme the heater to operate for a period of exactly one hour before automatically turning the heater off.

FILTER INDICATOR

When the fan filter becomes covered with dust and the temperature inside the appliance rises, the filter indicator will flash. The filter should be vacuumed at regular intervals to avoid unnecessary strain on the appliance.

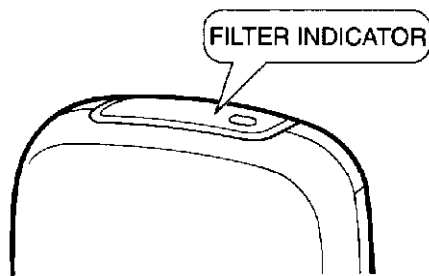

ECONOMY MODE

This is an automatic energy saving feature designed to reduce the room temperature to 1°C less than the pre-set temperature over a period of 30 minutes, and an additional 1°C after another 30 minutes.

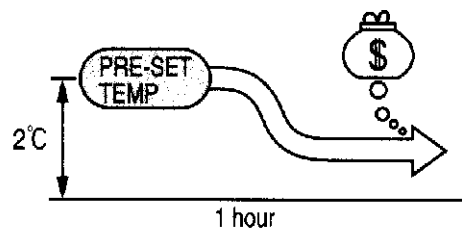

ON TIMER

The ON timer allows you to programme the heater to come on after a delay period.

This is a particularly useful feature to use overnight for automatic heating in the morning.

The appliance begins heating a room once it has reached the end of the delay time selected.

The heater will automatically come on and then remain on until you turn it off manually.

IMPORTANT POINTS

Unpack heater :

Check for damage. If heater is damaged, contact your supplier for advice. Before installing the heater, check it is labelled for the correct gas type (See label on rear of heater). Refer to local gas authority for confirmation of gas type if you are in doubt.

Included in Carton :

Customers Operating Information

IMPORTANT

1. The appliance must be installed in accordance with the local gas authority regulations.
2. For information on gas rate, see data plate on the appliance.
3. When using this appliance, ensure that the room is correctly ventilated. Check AG 601 or the local gas authority for information on ventilation requirements.
4. **DO NOT install in a bedroom or bathroom.**
5. This heater must not be installed where curtains or other combustible materials could come into contact with it. In some cases curtains may need restraining. It must also be 50 mm clear of walls.
6. This appliance is not designed to be built in.
7. If you move house, check the gas type in the area where you are moving to. The local gas authority will be able to advise on local regulations.
8. This heater discharges a large volume of warm air at low level to provide even heat distribution. If the air in the room contains cooking vapour or cigarette smoke, and the heater is used on a carpet, the surface of the carpet may become discoloured. In addition, some nylon carpets contain dyes which may be affected by the warm air flow. Some soft vinyl surfaces are also subject to distortion, or discolouration by warm air. To prevent discolouration of carpets etc, a mat should be placed under the appliance, extending about 750 mm in front of it.

Diagram 1 shows clearances required around this heater whilst in operation.

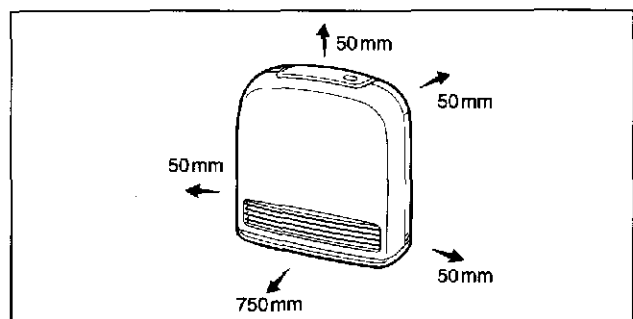

Do not install this heater in areas where spray painting or plating is taking place, or in places such as hair dressers, where there may be a lot of fluff and dust, and where aerosols are used.

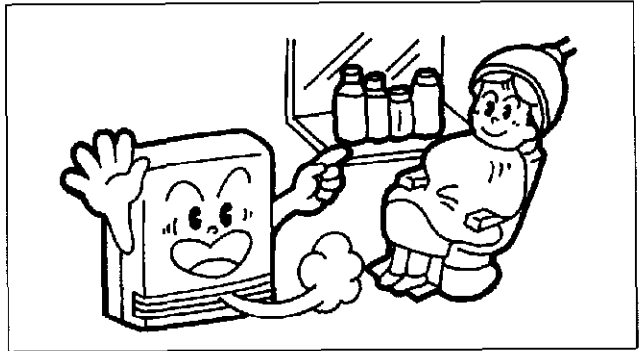

Turn off heater after use.

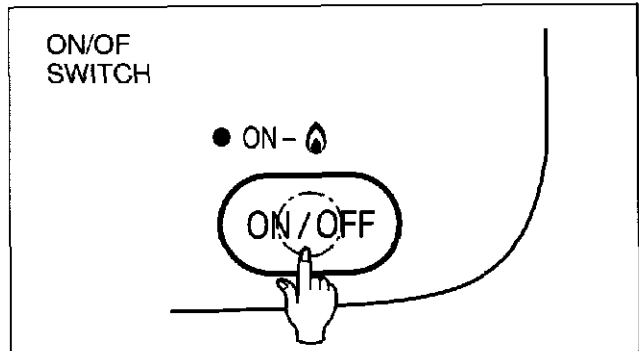

Keep away from flammable materials. Combustible materials must not be placed where the heater could ignite them.

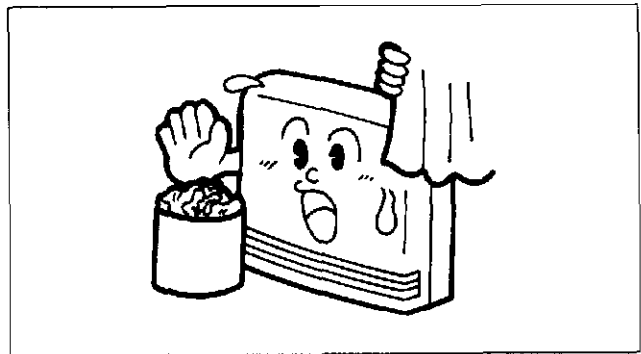

Do not spray aerosols near this heater while it is in use. Most aerosols contain butane gas, and can be a fire hazard if used near this heater when it is in use. Use of aerosols, paint, polishes etc. whilst this heater is in use may cause unpleasant smells.

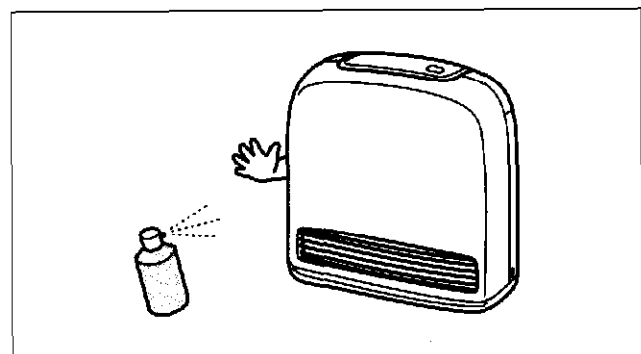

Do not sit on this heater.

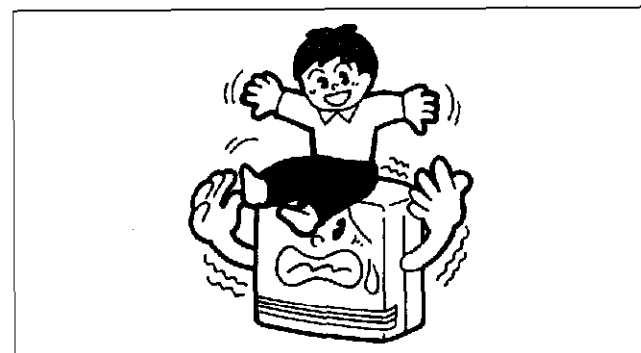

Do not allow children to post articles in the louvres.

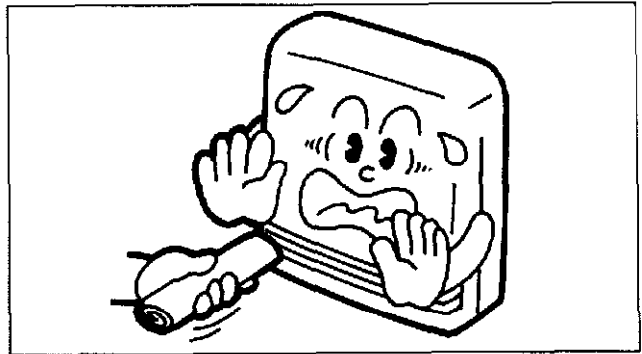

Supervise children playing near this heater.

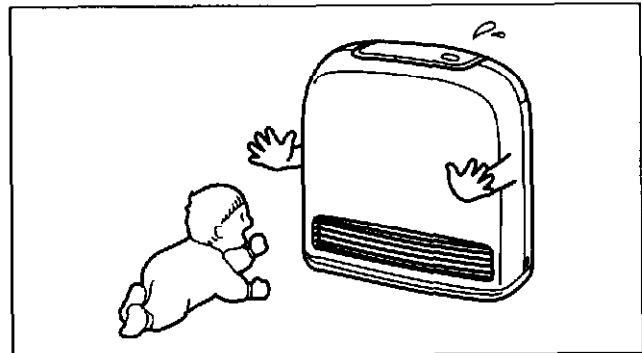

Do not allow children or elderly persons to sleep in the warm air discharge from the heater.

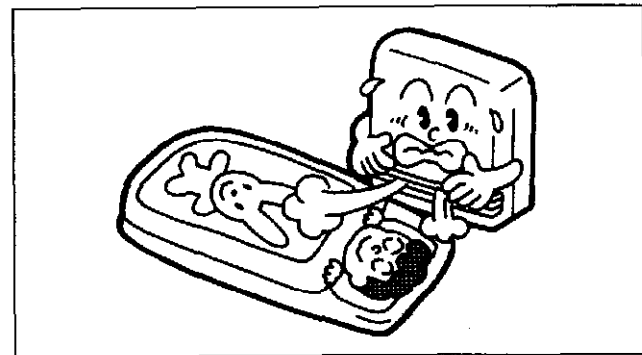

Do not place wet articles on this heater, the water may drip into the electrical parts.

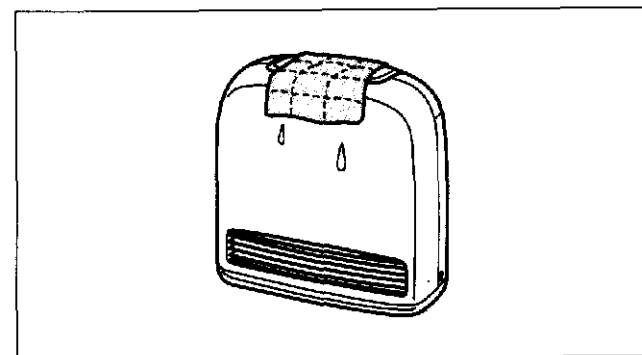

Ventilate the room when this heater is in use.

Correct, fixed ventilation is usually sufficient, consult your local gas authority for local regulations.

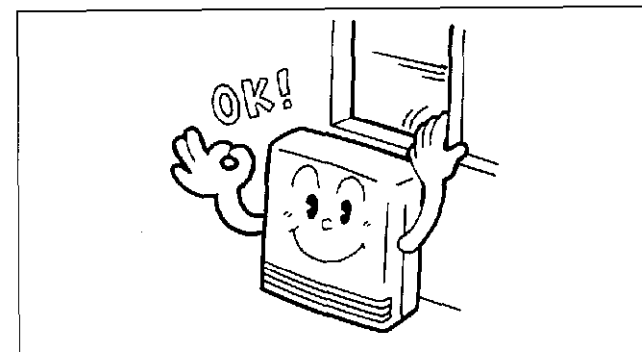

Do not place articles in front of the louvres.

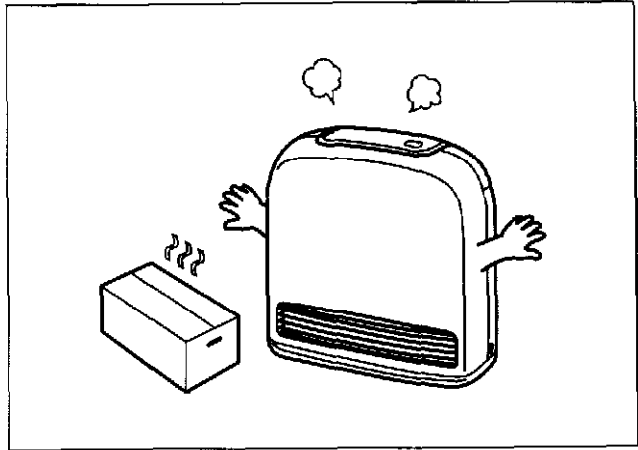

Do not move the heater whilst it is turned on.

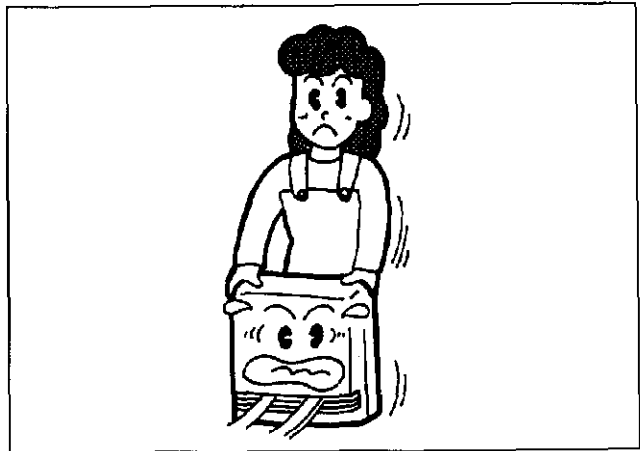

Do not turn the heater off by unplugging it from the wall.

Unplugging the heater will cause the timer to stop, however programmed ON/OFF times will remain in the memory.

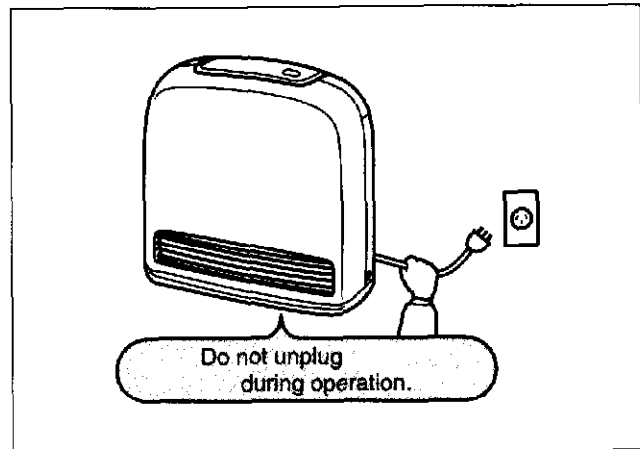

Do not place containers of liquid on top of the heater. Water in the heater can cause extensive damage.

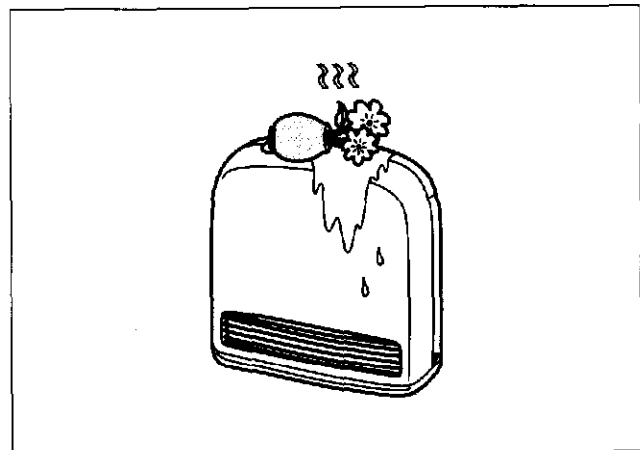

CUSTOMERS OPERATING INFORMATION

INSTALLATION

Check room size and ventilation.

The Convector 229 must not be in a room smaller than 20.0 m³.

Your Convector is fitted with a flexible hose with bayonet type plug in fitting, simply plug into your bayonet floor fitting.

■ TURNING ON

Press the ON/OFF button to operate the heater. The ON indicator will glow green. After approximately 15 seconds the spark generator will be heard before the burner ignites and the ON indicator glows red, indicating that the burner is alight.

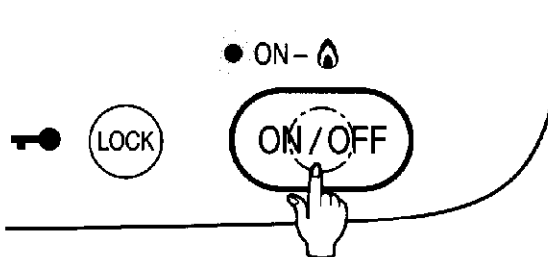

If the heater does not ignite on initial use, this may be due to air remaining in the gas supply line. The spark generator will only continue for 15 seconds. After this it will be necessary to press the ON/OFF button OFF, then ON again.

■ ROOM TEMPERATURE ADJUSTMENT

The room temperature and pre-set temperatures can only be displayed and adjusted when the heater is running.

1

Press the “▲” button to increase the temperature setting or “▼” button to decrease the temperature setting.

The Temperatures can be preset to:

- [L] low (about 10°C)
- [16°C] to [26°C] in 1°C steps
- [H] (continuously high)

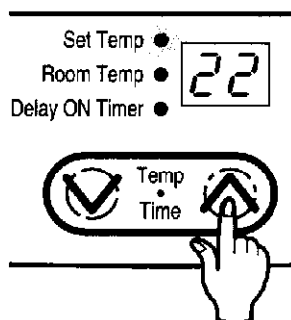

If the heater does not ignite then the pre-set temperature may not be set to a setting which is higher than the actual room temperature.

■ CHILD LOCK

The Child lock will help to prevent accidental operation as well as helping to prevent small children from altering the controls.

1

The Child lock can be operated either when the heater is running, or in the "stand by" mode, simply press the Lock button. The function is activated immediately and the Child lock indicator will glow.

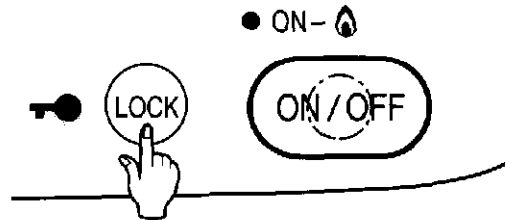

2

To deactivate the Child lock, simply press the Child Lock button for 2 seconds and the Child lock indicator will go out. The lock can be deactivated at any time in this way.

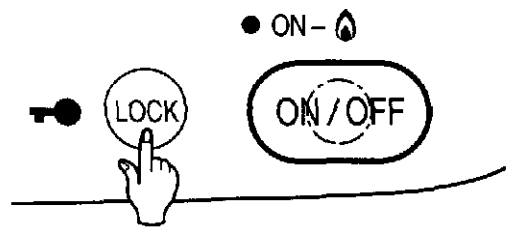

When the Child lock is activated during normal operation all controls other than the OFF switch will be locked. Deactivating the lock releases the controls. If the lock is activated whilst the heater is turned OFF, then all functions will be locked. If the heater is turned OFF whilst the Child lock is activated, it cannot be turned ON again until the lock is deactivated.

■ ECONOMY MODE

The Economy mode only operates when the heater is turned on.
The Economy mode operates automatically.

1

The Economy indicator will glow to show that the Economy function is activated.

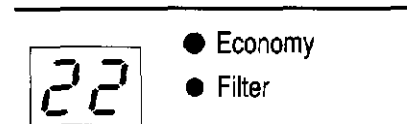

After the room is heated initially the air temperature may be dropped to a lower level without affecting comfort. 30 mins after the selected room temperature (set with the thermostat) is reached, the Economy mode, if set, reduces the temperature by 1°C. After another 30 mins it reduces the temperature by a further 1°C. This is an energy saving feature. The Economy mode does not operate if the heater is under capacity for the room size.

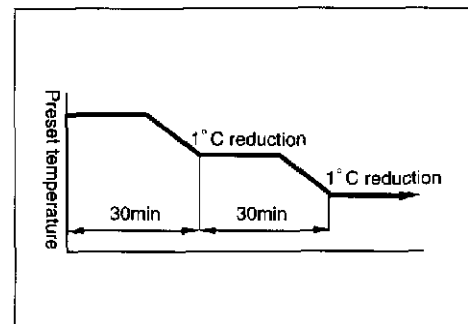

TURNING UNIT OFF

Simply press the ON/OFF button to switch off the heater. The ON indicator will go out.

The convection fan will continue to operate for several minutes after the burner has gone out in order to cool the appliance. **Do not unplug the appliance while the convection fan is running.**

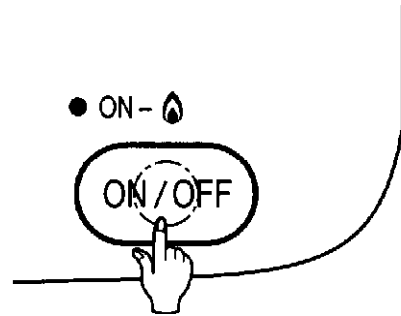

DO NOT turn heater off by unplugging at the power point.

The convection fan will continue to run until the appliance cools.

TIMER OPERATION

OFF Timer Operation

This feature is useful on cold nights when the unit continues to operate after you have gone to bed.

*Please Note : this heater is not permitted to be installed in a bedroom.

The OFF Timer can be selected when the heater is operating manually, is OFF, or in On Timer mode.

When the OFF Timer feature is selected, the heater will automatically switch off after 60 minutes.

1. Press the OFF Timer button.

- The OFF Timer indicator lights up.
- The heater will operate at the preset temperature selected in the system memory.
- The temperature will automatically run at 26°C if the set temperature is "H".
- If selected while the unit is OFF, the unit will start up and begin heating.
- If selected while the ON Timer is set, the heater will come on and run for 60 minutes, after which it will remain in ON Timer Standby mode.
- If the ON Timer is selected after the OFF Timer has been selected, the unit will run for 60 minutes (OFF Timer mode) and then remain in the ON Timer standby mode.

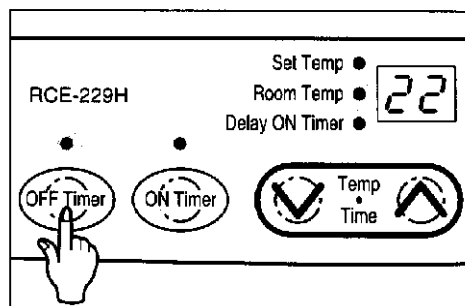

In all cases where the ON and OFF Timers are selected together, the OFF Timer will take precedence and run the heater for 60 minutes after which the heater will remain in the ON Timer standby mode.

2. OFF Timer stops after 1 hour.

- Five minutes before the finish of the OFF Timer, the OFF Timer indicator will flash, indicating that the function is nearing completion.
- The OFF Timer indicator will then go out at completion of the 60 minute time delay.
- In cases where both the ON and OFF Timers are selected, once the OFF Timer has run the heater for 60 minutes, the ON Timer indicator will remain alight and the heater will be in ON Timer standby mode.

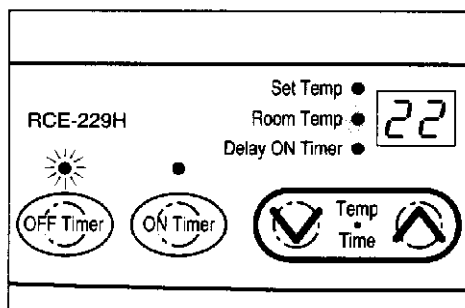

To cancel the OFF Timer, press either the ON-OFF button or the OFF Timer button at any time.

ON Timer Operation

The ON Timer allows you to programme the heater to turn on after a pre-determined time period.

As an example, if the time now is 10:30 pm and you wish the heater to start at 6:00 am tomorrow morning, then the ON Timer must be set to 7.5 (hours).

- The ON Timer preset times are from 30 minutes to 24 hours.
- These times can be selected in 30 minute increments up to 10 hours and then 1 hour increments up to the maximum of 24 hours.

1. Before selecting the ON Timer confirm:

- That the desired preset room temperature has been set (see page 10).

WARNING

- Ensure there are no obstacles or foreign materials directly in front of the appliance where the warm air will discharge into the room.
- Ensure the appliance is not positioned where warm air discharge will blow directly on someone sleeping. (This appliance must not be used in a bedroom.)

2. Press the “ON Timer” button

- The “ON Timer” and “ON/Combustion” (green) indicators will light up.
- A preset time will be displayed on the digital monitor. (The first time the ON Timer is preset, this time will be “8.0”)
- The ON Timer can be selected while the unit is in operation, or while it is off (if set during operation, pressing the ON Timer button will stop the unit heating and the ON/Combustion indicator will change from red to green). The appliance will remain in standby mode.

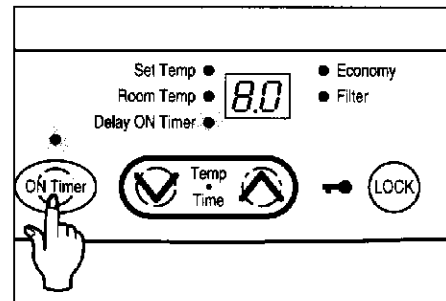

ON Timer Operation continued

3. Presetting the time

- Pressing the “∨” or “∧” buttons alters the preset time.
- After 10 seconds the digital monitor will go out.
- If the display has gone out:
 - Pressing the “∨” or “∧” buttons once will show the remaining time on the digital monitor.
 - Pressing the button more than once will alter the preset time.

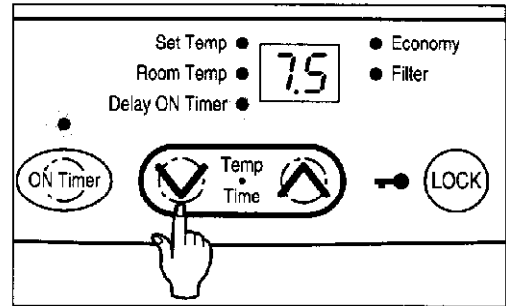

4. The heater will operate after reaching the end of the preset time.

- “ON/Combustion” Indicator glows red.
- The heater will operate at the preset temperature selected in the system memory.
- The heater will automatically operate at 26°C if the preset temperature is set to “H”.

5. The heater stops automatically after 1 hour.

- The “ON Timer” indicator will flash to indicate that heating is about to stop (at approximately 55 minutes). After another 5 minutes the heater will automatically stop heating and turn off completely.
- The “ON Timer” indicator will continue to flash until the heater is manually operated again. The “ON/Combustion” indicator will go out.
- Pressing the ON-OFF button will turn off the ON Timer indicator.

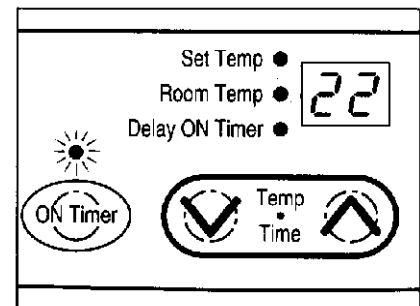

To Cancel the ON Timer

Press the “ON Timer” button or press the “ON-OFF” button.
The setting will be cancelled and the timer indicators will go out.

The ON Timer will be cancelled if the power plug is removed from the power point, a power failure while the appliance was in standby mode, or if the ON Timer setting is cancelled. “00” will flash on the digital monitor when power is reinstated. Pressing the ON button and starting the unit will delete the “00”.

SAFETY DEVICES

■ Over Heat Thermistor

When the heater gets too hot during operation (for example when the filters or air outlet louvres are blocked), this device turns the gas off automatically. Remove cause of overheat (clean filters), allow heater to cool, then re-ignite.

■ Fuse

The electrical circuits are protected by a fuse. When the fuse blows, the heater will not operate at all. The fuse must be replaced by an authorised person.

■ Flame Failure Device

This device automatically cuts off the gas supply to the heater in the event of a gas failure. To restore the gas supply to the heater, turn it off, then follow the ignition procedure.

■ Oxygen Depletion Safety Device

If the oxygen level in the room drops below a pre-set limit, this device cuts the gas supply to the heater. If the oxygen depletion device operates, turn the heater off, ventilate the room, then follow the ignition procedure to re-light. Heater will not re-light until room is fully ventilated.

■ Tilt Switch

If the heater is knocked over, the tilt switch will cut the gas supply. The fan keeps running. To restore the gas supply, stand the heater upright, turn it off then follow the ignition procedure. The tilt switch may also operate if the heater is jolted or picked up whilst in operation.

■ Power Failure

In the event of a power failure or power cut, the gas valves will automatically close. After the power is re-instated the appliance must be operated manually.

CARING FOR YOUR NEW RCE-229H

Your Convector needs very little maintenance, but the following information will help you to keep it looking good, and working efficiently.

Unplug before cleaning.

All parts of the heater can be cleaned using a soft, damp cloth.

Do not use solvents to clean any parts.

Do not spray aerosols in the vicinity of this heater whilst in operation.

Do not place articles on or against this heater.

Do not store flammable materials near this heater.

AIR FILTERS

Dusty filters reduce the air flow through the heater as well as reducing the heater's effectiveness.

Do not wait for filter warning lamp to come on before cleaning filters.

Do not use the heater with the filter warning lamp on, this may cause it to overheat.

Note:

The filter requires cleaning at least once a week during the heating season to prevent unnecessary cut-out due to a build up of dust particles.

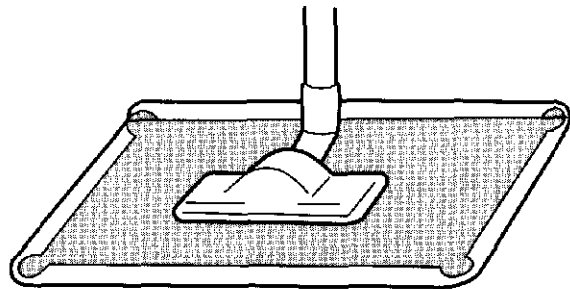

Clean both air filters with vacuum cleaner at least once a week.

Small filter should be left in position for cleaning.

FAULT FINDING CHART

Please note : General cleaning, maintenance and wear and tear are not necessarily covered under the guarantee. Calls of this nature may be chargeable.

Problem Cause	No ON indicator	Burner doesn't ignite	Filter warning Lamp glows	Combustion stops during operation	Smell of gas	Takes too long to warm the room	Remedy
Not Plugged In	●	●					Plug In
Power Cut	●	●		●			Re-ignite manually after power is restored
(Initial Installation) Air in gas pipe		●					Purge air (Installer)
Air in the hose		●					Repeat ignition procedure
Room too large						●	Check with retailer
Dust on the air filters			●				Clean the air filters (Weekly)
Louvre obstructed				●		●	Clean obstruction
Air filter blocked				●		●	Clean filter (Weekly)
Gas Escape					●		Service Call (Contact Rinnai)
On Timer is set		●					Cancel On Timer
Child Lock set		●					Cancel Child lock
Gas turned off at meter or cylinder	●	●					Turn gas on

SERVICE

Rinnai Australia has a service and spare parts network in all states. Our service network personnel are fully trained and equipped to give the best service on your Rinnai appliance. If your appliance needs service, please ring one of the service contact numbers on the back of this booklet.

Rinnai recommend that this appliance be serviced every 2 years.

Fault Failure Procedure

If you are unsure about the way your heater is operating, contact Rinnai Australia, or your local agent.

SPECIFICATION

DIMENSIONS

Dimensions in mm

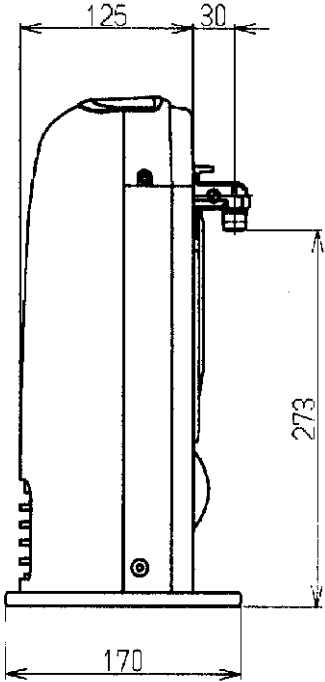
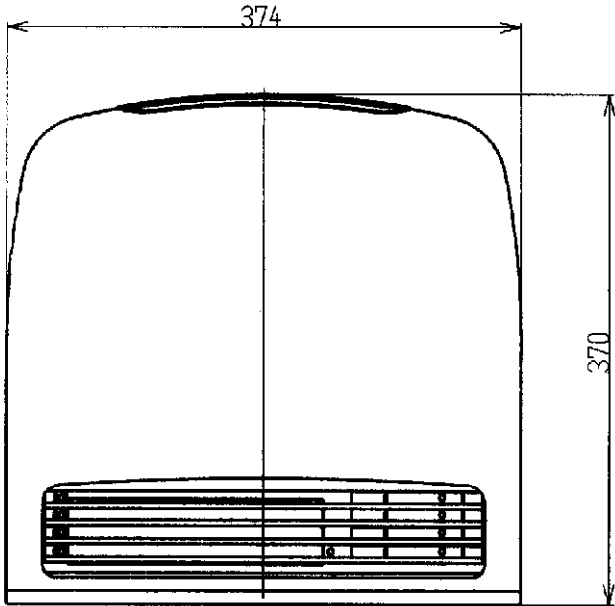
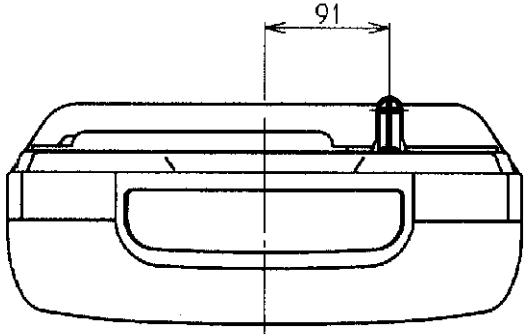

WIRING DIAGRAM

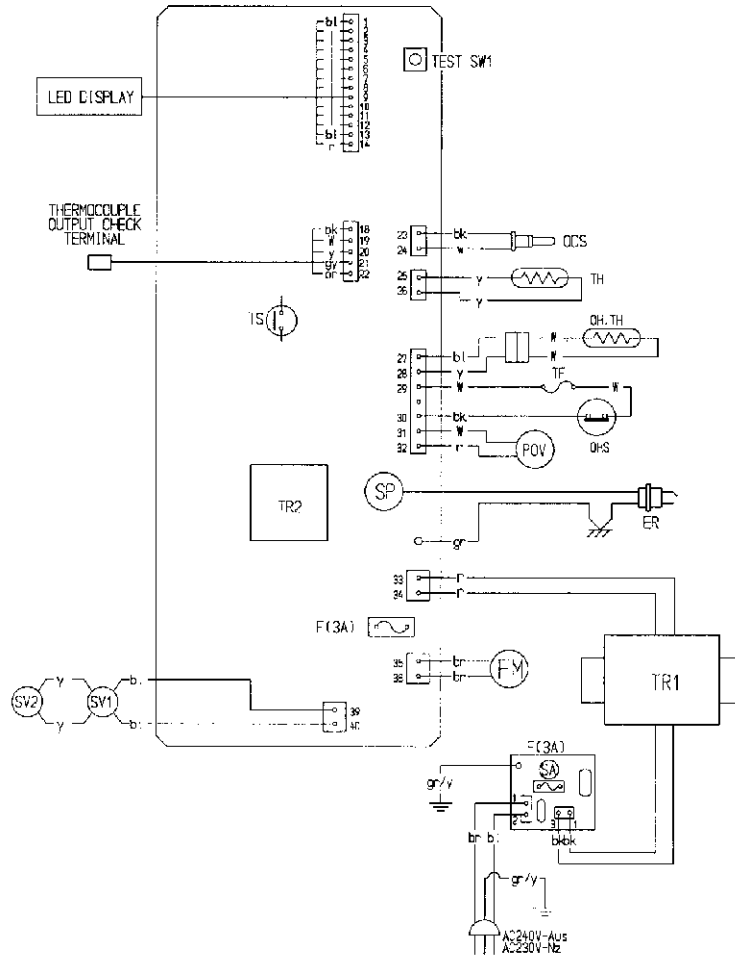

BLOCK DIAGRAM

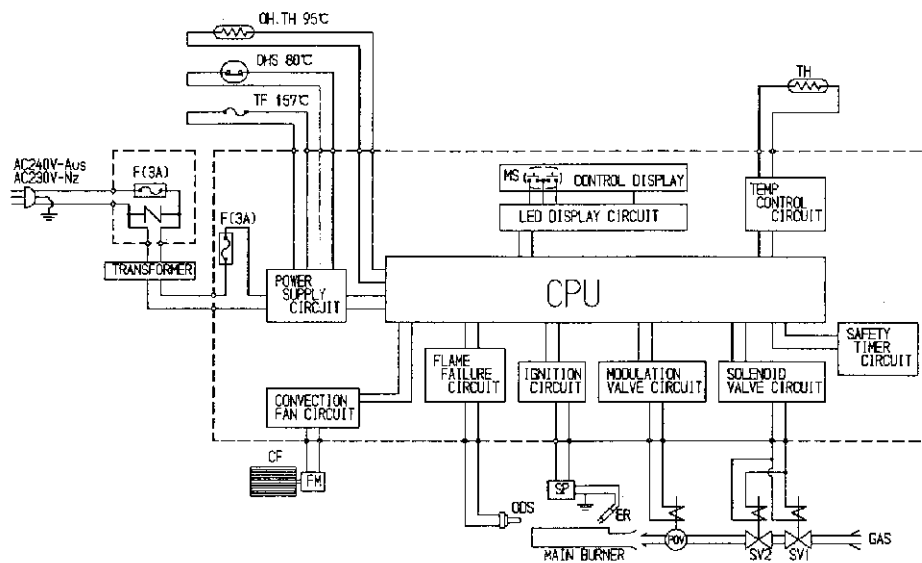

SPECIFICATIONS

Description :	Convactor 229 (RCE-229H)
Type :	Forced convection unflued space heater
Input :	NG-8 MJ/h Propane-8 MJ/h
Gas Control :	Rinnai Electronic Modulating Control
Burner :	Rinnai Stainless Steel Burner
Test Point Pressure :	NG- 0.88 kPa Propane- 1.37 kPa
Gas Inlet :	Supplied with hose and plug
Ignition :	Electronic
Power Supply :	230 V 50 Hz, unit is fitted with a supply lead and 3 pin plug, replace only with Rinnai part number 90148206.
Injectors & Gas Type :	Please see data plate.
Dimensions :	Width 374 mm, Height 370 mm, Depth 170 mm.

You can rely on
Rinnai

SERVICE CONTACT POINTS

RINNAI NEW ZEALAND LTD.

691 MT ALBERT RD, ROYAL OAK
AUCKLAND
P.O. BOX 24-068 AUCKLAND
PHONE: 625-4285, 0800 RINNAI
FAX: 624-3018