

Rinnai

MC-100V & BC-100V

Operation / Installation Manual

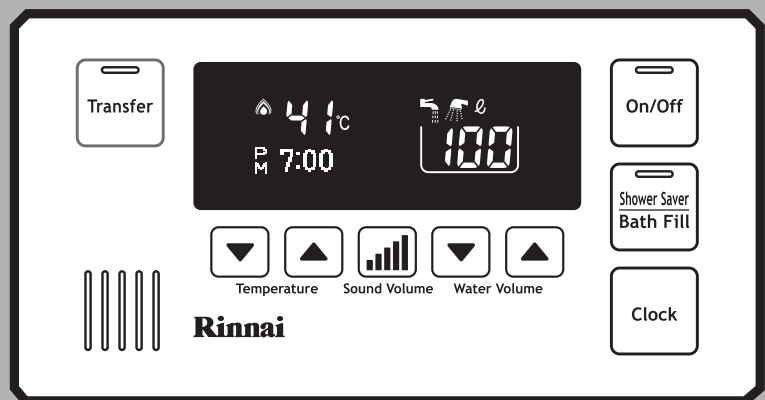
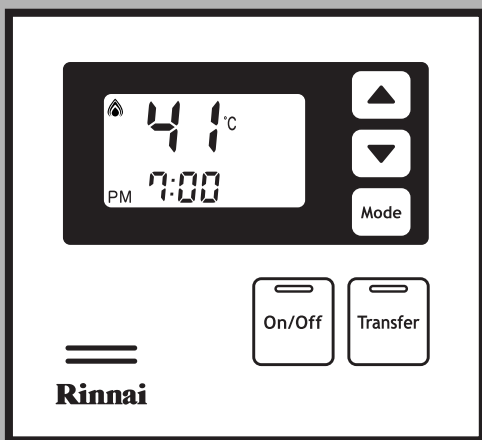

A guide on how to use and install Rinnai deluxe water controllers

This guide is for the use and installation of Rinnai Deluxe water controller models MC-100V and BC-100V.

These instructions must be used in conjunction with the Rinnai Water Heater Operation / Installation Manual supplied with Rinnai water heaters.

These water controllers are compatible only with the Rinnai water heater and other water controller models shown.

Refer to the table located on page 1 of this manual to confirm the maximum number and combination of controllers that can be fitted to your Rinnai water heater model.

Compatible Rinnai water heater models:

Infinity XR32	HD-200
Infinity XR26	HD-200i
Infinity XR24	HD-250
Infinity XR20	HD-250i
Infinity XR18	
Infinity XR16	
Infinity XR26i	
Infinity XRPlus 26	
Infinity XRPlus 20	
Efficiency 24	

Compatible Rinnai water controller:

Universal wired controller	MC-91
Wireless controller	MC502S

This appliance shall be installed in accordance with:

- Manufacturer's Installation Instructions
- Current AS/NZS 3000, AS/NZS 3500 & NZS 5261
- Local Regulations and Municipal Building Codes

This appliance must be installed, serviced and removed by an Authorised Person.

REGULATORY INFORMATION

Controllers and water heaters must be installed correctly by an authorised person. The installation of gas, water, and electricity must conform to local regulations.

The installation must also comply with the instructions supplied by Rinnai.

Please keep this instruction booklet in a safe place for future reference.

All dimensions referred to in these instructions are in millimetres, unless otherwise specified.

WARNING ABOUT HOT WATER



Excessively hot water is dangerous, especially for young children and the infirm. Rinnai water heaters allow you to control the temperature of hot water to safe levels.

Water temperatures above 55°C can cause severe burns instantly and may even result in death. Those most at risk are children, disabled, elderly and the infirm. Hot water at 65°C (the average hot water temperature in New Zealand) can severely burn a child in less than half a second. At 55°C it takes half a minute.

ALWAYS.....

Test the temperature of the water with your elbow before placing your child in the bath, also carefully feel water before bathing or showering yourself.

Supervise children whenever they are in the bathroom.

Make sure that the hot water tap is turned off tightly.

CONSIDER.....

Installing child proof tap covers or child resistant taps (both approaches will prevent a small hand being able to turn on the tap).

Setting your appliance at a maximum temperature of 55°C (Contact Rinnai New Zealand).

NEVER.....

Leave a toddler in the care of another child. They may not understand the need to have the water temperature set at a safe level.

OPERATION MANUAL

REGULATORY INFORMATION	i
WARNING ABOUT HOT WATER	i
GENERAL WATER CONTROLLER INFORMATION	1
DELUXE WATER CONTROLLERS	2
ABOUT THE DELUXE KITCHEN WATER CONTROLLER (MC-100V).....	2
HOW TO USE THE DELUXE KITCHEN WATER CONTROLLER (MC-100V).....	2
ABOUT THE DELUXE BATHROOM WATER CONTROLLER (BC-100V)	4
HOW TO USE THE DELUXE BATHROOM WATER CONTROLLER (BC-100V).....	4
OPERATING THE SHOWER SAVER / BATH FILL FUNCTION.....	6
USING MULTIPLE CONTROLLERS.....	7
COMBINING UNIVERSAL AND DELUXE CONTROLLERS.....	7
WATER CONTROLLER INSTALLATION	8
WATER CONTROLLERS.....	8
POSITIONING OF WATER CONTROLLERS	8
WATER CONTROLLER CABLES	8
FITTING THE 'DELUXE KITCHEN' WATER CONTROLLER (MC-100V).....	8
FITTING THE 'DELUXE BATHROOM' WATER CONTROLLER (BC-100V)	9
CONTACT INFORMATION	13

GENERAL WATER CONTROLLER INFORMATION

Temperature water controllers allow precise temperature control by the user. When used correctly, the hot water unit will deliver the selected temperature, even when the water flow is varied, or more than one tap is in use. Each water controller can be individually programmed, however the water heater can only deliver one set temperature at any time. The available temperatures (°C) are as follows:

Kitchen Controller:

37, 38, 39, 40, 41, 42, 43, 44, 45, 46, 48, 50, 55°C* (60°C, 65°C, 75°C HD models only)

Bathroom Controller:

Hot Water Delivery: 37, 38, 39, 40, 41, 42, 43, 44, 45, 46, 48, 50°C

Bath fill Delivery: 37, 38, 39, 40, 41, 42, 43, 44, 45, 46, 47, 48°C

Whilst hot water outlets are open the set temperature may be lowered. However the set temperature cannot then be raised above 43°C. In addition transfer of 'priority' between controllers is not possible. These are safety features.

Suggested temperatures are:

Kitchen 50°C ~ 55°C* Shower 37°C ~ 43°C, Bath fill 39°C ~ 45°C

** Temperature may not be available on all installations. Rinnai water heaters can be programmed to deliver higher temperatures via the kitchen controller. Contact Rinnai for more details.*

These temperatures are suggestions only. You may find higher or lower temperatures more comfortable. Maintaining lower temperatures helps save energy. To obtain water temperatures lower than 37°C simply add cold water.

Water controllers are an optional extra. 'Universal' and 'Deluxe' water controllers can be fitted. Universal Controllers allow temperature selection only. Deluxe controllers allow temperature selection, bath fill and have a clock function.

Water controllers allow the water temperature to be set from the various locations where they are installed. The temperature selected will be available to all outlets.

Universal (MC-91-2A) and Deluxe (MC-100V & BC-100V) Controllers - available configuration:

A maximum of 4 water controllers can be fitted. Any combination of the deluxe, universal and wireless controllers can be used with the following limitations.

Only ONE master controller can be installed. This can be MC-100V, a MC-91 (when programmed as a master controller) or a MC502S (wireless) controller.

Up to TWO BC-100V water controllers can be installed.

The FOURTH water controller in any installation MUST BE a MC502S (wireless) or a MC-91.

DELUXE WATER CONTROLLERS

ABOUT THE DELUXE KITCHEN WATER CONTROLLER (MC-100V)

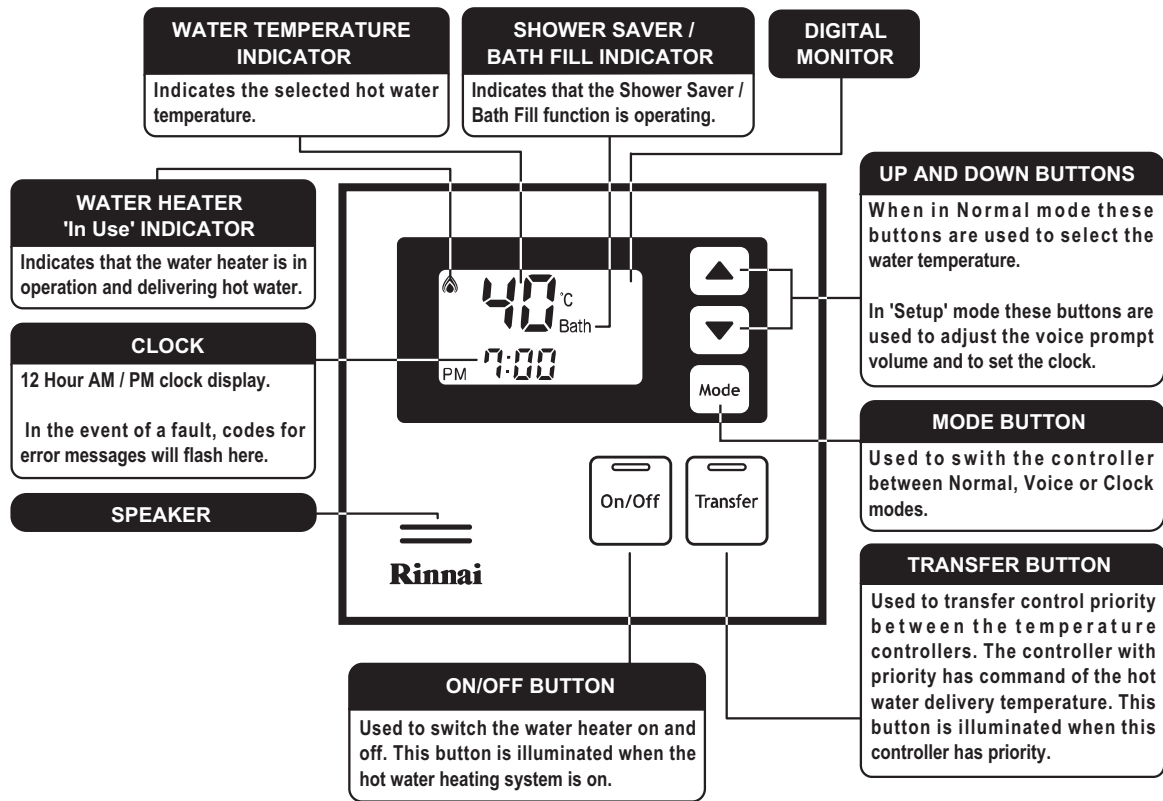

HOW TO USE THE DELUXE KITCHEN WATER CONTROLLER (MC-100V)

Turning on the Controller

If the controller is switched off (No digits other than the clock digits displayed in the digital monitor) press the On/Off button once.

The On/Off and Transfer buttons illuminate to indicate that the hot water unit will be ready to supply hot water once a hot water tap is opened.

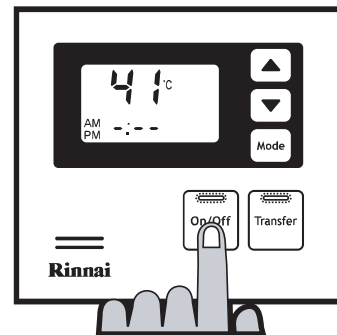

If more than one controller is fitted press the 'Transfer'  button to transfer priority to the desired controller.



The MC-100V controller is not water resistant, avoid direct exposure to water or steam as these conditions may cause damage.

Setting The Clock

The clock is a 12 hour AM/PM style display. To set the time press the 'Mode'  button twice, this places the controller into clock setting mode, in the digital monitor the word 'Clock' will be displayed and the clock digits will flash, if this is the first time the clock has been set the starting time will be AM 12:00.

Use the  or  buttons to select the desired time, holding these buttons down continuously cycles the digits. When you get close to the time you wish to set, press the button intermittently to avoid going further than the desired time.

DELUXE WATER CONTROLLERS

To return to normal mode press the 'Mode'  button once, if no buttons are pressed for a period of approximately 10 seconds the controller will return to normal mode.

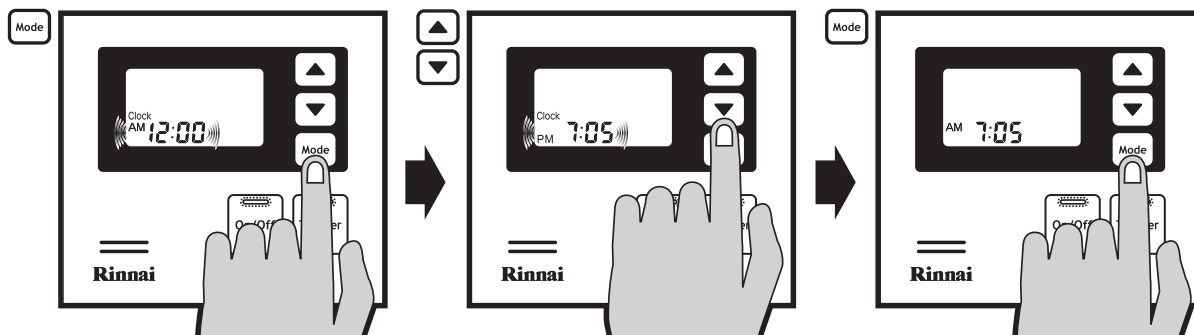



The time is always displayed regardless of whether the Water Controller is turned ON or OFF.

The clock may need resetting if power to the water heater unit is disrupted due to a power failure or if the power is switched off over a prolonged period.

Setting The Sound Options

To set the sound options press the 'Mode'  button once to place the controller into 'Voice' mode.

Use the  or  buttons to select the desired audible setting as follows:



Voice High, Med, Low or Off, sets the voice prompt volume but does not affect the audible tones.
Sound Off, mutes all voice prompts and audible tones.

To return to normal mode press the 'Mode'  button once, if no buttons are pressed for a period of approximately 10 seconds the controller will return to normal mode.





Voice prompts only available when Deluxe Bathroom water controller(s) are installed.

Adjusting Temperature

Simply press the 'hot water temp'  or  buttons until the required temperature is displayed on the Digital Monitor.

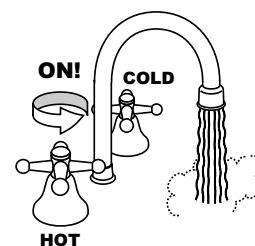
To operate the water heater, open any hot water tap. This will automatically light the burner, providing hot water. The 'In Use' indicator  will illuminate on the Water Controller.



Once the hot water is running, if the set temperature is either too hot or cold press the  or  buttons until the desired temperature is reached.



Whilst hot water outlets are open the set temperature may be lowered. However they cannot then be raised above 43°C. In addition transfer of 'priority' between controllers is not possible. These are safety features.



CHECK WATER TEMPERATURE BEFORE USE.
A parent or carer should always check the temperature before a child is placed in contact with hot water.

DELUXE WATER CONTROLLERS

ABOUT THE DELUXE BATHROOM WATER CONTROLLER (BC-100V)

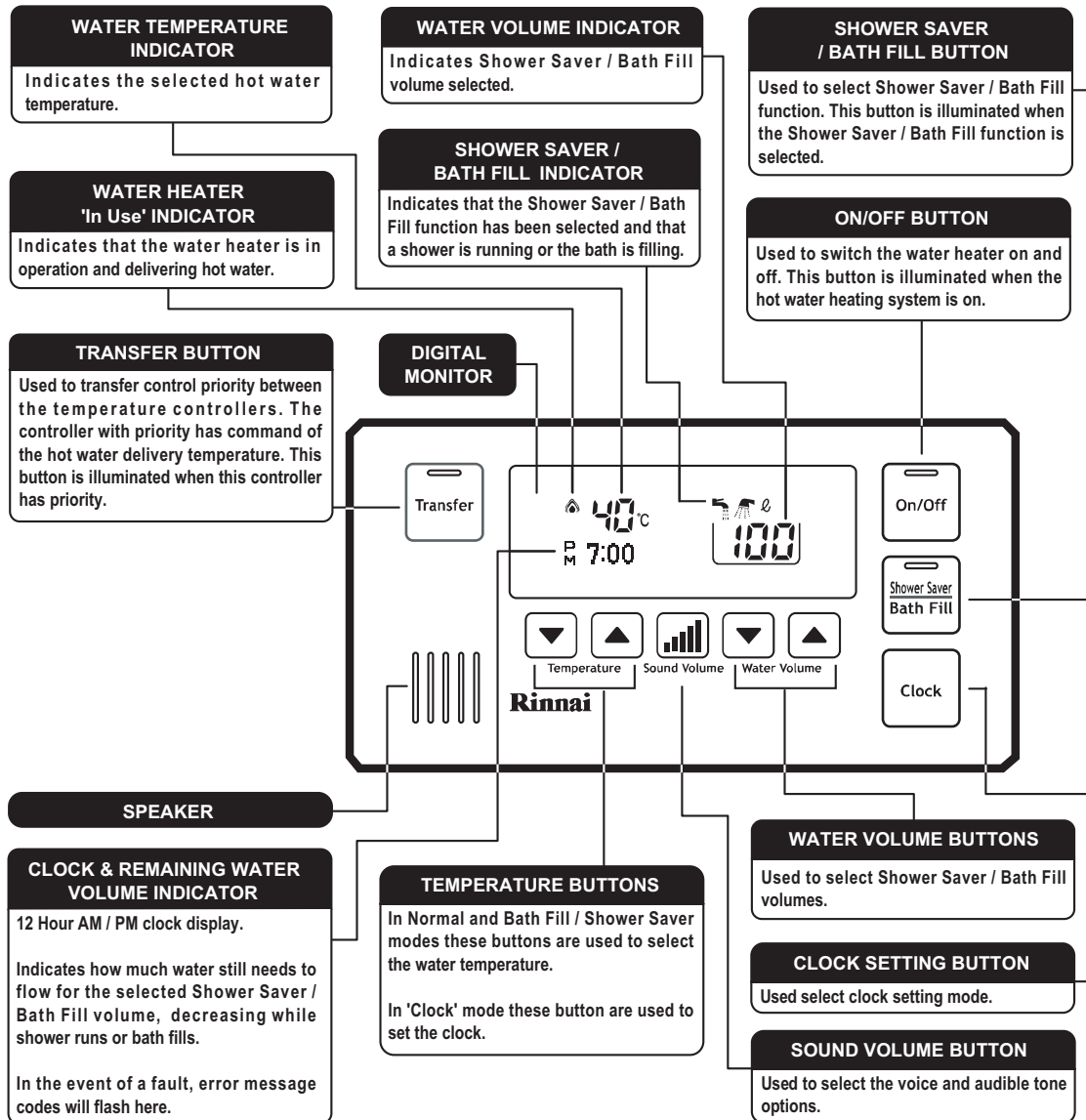

HOW TO USE THE DELUXE BATHROOM Water CONTROLLER (BC-100V)

Turning on the Controller

If the controller is switched off (No digits other than the clock digits displayed in the digital monitor) press the On/Off button once.

The On/Off and Transfer buttons illuminate to indicate that the hot water unit will be ready to supply hot water once a hot water tap is opened.

If more than one controller is fitted press the 'Transfer' button to transfer priority to the desired controller.

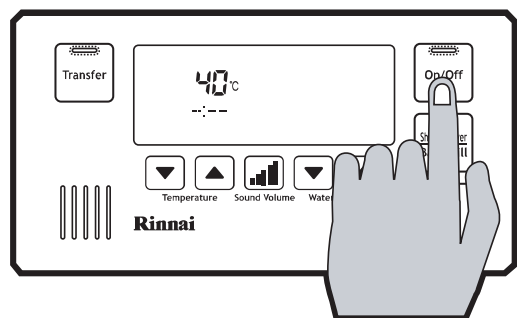

NOTE

Refer to page 1 to confirm the maximum number and combination of water controllers that can be fitted to your Water Heater model.



Avoid getting water directly in the speaker as this may cause damage.

DELUXE WATER CONTROLLERS

Setting The Clock

The clock is a 12 hour AM/PM style display.

To set the time press the 'Clock'  button once, this places the controller into clock setting mode, in the digital monitor the clock digits will flash, if this is the first time the clock has been set the starting time will be AM 12:00.

Use the 'Temperature'  or  buttons to select the desired time, holding these buttons down continuously cycles the digits. When you get close to the time you wish to set, press the button intermittently to avoid going further than the desired time.

To return to normal mode press the 'Clock'  button once, if no buttons are pressed for a period of approximately 60 seconds the controller will return to normal mode.

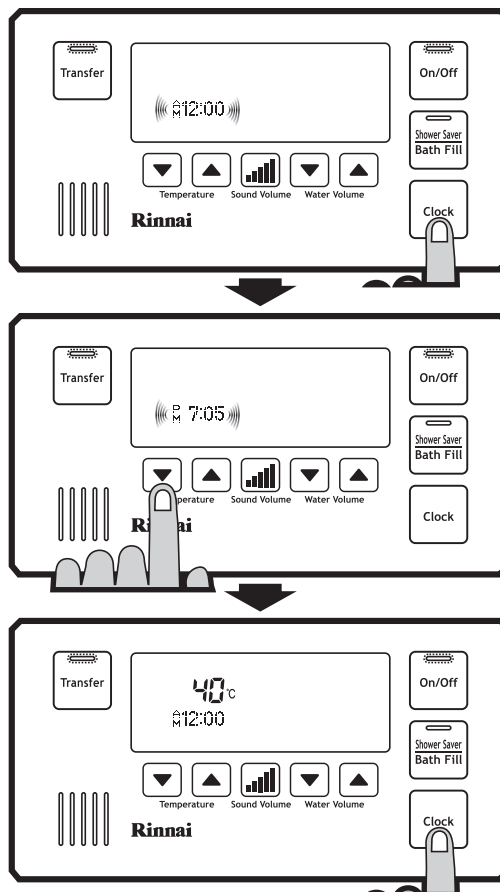



The time is always displayed regardless of whether the Water Controller is turned ON or OFF.

The clock may need resetting if power to the water heater unit is disrupted due to a power failure or if the power is switched off over a prolonged period.



Setting The Sound Options

To set the sound options press the 'Sound Volume'  button and select the desired audible setting as follows:



Voice High, Med, Low or Off, sets the voice prompt volume but does not affect the audible tones.
Sound OFF, mutes all voice prompts and audible tones.

Press any of the  or  buttons to return to normal mode, if no buttons are pressed for a period of approximately 10 seconds the controller will return to normal mode.

Adjusting Temperature

Simply press the 'Temperature'  or  buttons until the required temperature is displayed on the digital monitor.

To operate the water heater, open any hot water tap. This will automatically light the burner, providing hot water. The 'In Use' indicator  will illuminate on all Water Controllers.

Once the hot water is running, if the set temperature is either too hot or cold press the 'Temperature'  or  buttons until the desired temperature is reached.

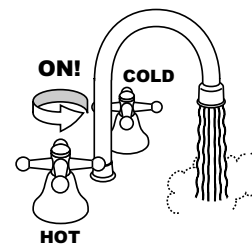

Whilst hot water outlets are open the set temperature may be lowered. However they cannot then be raised above 43°C. In addition transfer of 'priority' between controllers is not possible. These are safety features.



CHECK WATER TEMPERATURE BEFORE USE.
A parent or carer should always check the temperature before a child is placed in contact with hot water.

DELUXE WATER CONTROLLERS

OPERATING THE SHOWER SAVER / BATH FILL FUNCTION

The 'Shower Saver / Bath Fill' function allows a preset water volume and temperature to be selected and run automatically.





No voice prompts will be available if the 'Voice OFF' or 'Sound OFF' options are selected. With 'Sound OFF' there will also be no audible tones.

Initial Settings

When a deluxe bathroom controller is first turned on, the default shower / bath fill temperature is set to 40°C and the shower / bath volume is set to 100 litres. The shower / bath volume can be lowered to a minimum of 30 litres or raised to a maximum of 400 litres and the temperature adjusted as desired.



Setting Shower / Bath Temperature and Volume

With the system on, select a Deluxe Bathroom controller and ensure that it currently has priority. If it does not have priority press the 'Transfer'  button once and the 'Transfer' button will illuminate.

Press 'Shower Saver / Bath Fill'  button once. The 'Shower Saver / Bath fill' button will illuminate and a voice prompt and tone will sound.

To select the desired delivery temperature use the 'Temperature'  or  buttons.

The selected temperature will be displayed on the digital monitor and will remain as the default 'Shower Saver / Bath Fill' temperature until it is changed or if the mains power is turned off for an extended period.

To select the volume of water to be used in the shower / bath use the 'Water Volume'  or  buttons. The selected volume is displayed in large digits to the right and will remain as the default 'Water Volume' until it is changed or if the mains power is turned off for an extended period.

The selected volume is also repeated in the form of a remaining volume counter below the temperature and replaces the clock during 'Shower Saver / Bath Fill' operations.

When filling a bath for the first time, it is recommended that a low bath fill volume such as 60 litres or lower be used. During any subsequent bath fills the volume can then be adjusted to suit your known bath volume and or desired fill level.



Be careful not to overfill the bath, an average bath volume is 160 litres. It is recommended that when filling a bath for the first time you should:

- Remain by the bath during the filling process.
- Use a low bath fill volume such as 60 litres or less.

Using Shower Saver / Bath Fill

Press 'Shower Saver / Bath Fill'  button once. The 'Shower Saver / Bath fill' button will illuminate and a voice prompt and tone will sound. During 'Shower Saver / Bath Fill' operations the 'Bath' indicator will also be displayed in the deluxe kitchen water controller digital monitor (when fitted).

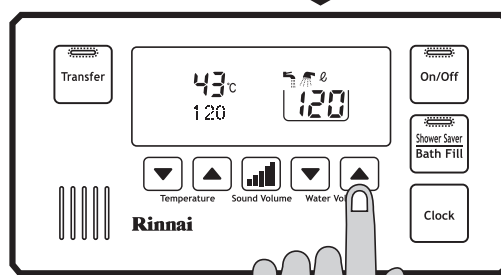
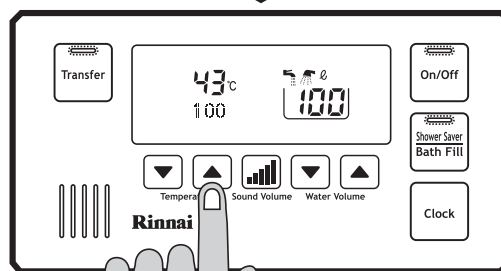
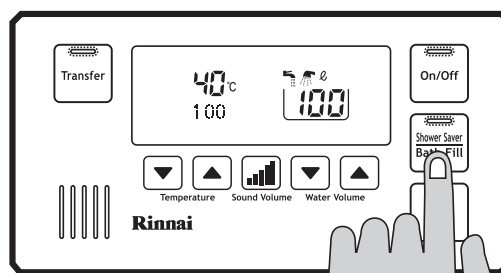

DELUXE WATER CONTROLLERS

The voice prompt will say "The hot water system is ready. Open the hot water tap". Open the hot water tap for the relevant shower or bath.

The 'In Use' indicator  will illuminate on all deluxe water controllers and the shower will run or the bath will start to fill.

To Stop Shower Saver / Bath Fill Operation

If you wish to stop the water flow whilst the shower saver / bath fill function is in operation, simply press the 'Shower Saver / Bath fill'  button.

The 'Shower Saver / Bath fill' button will flash and the voice prompt will say "Hot water is not available, Turn off all hot water taps and push the 'Bath fill' button". Follow the voice prompt instructions.

When Shower Saver / Bath Fill Operations Finishes

Once the shower saver / bath fill operation finishes the following events will occur:

1. The flow from the shower / bath hot water tap ceases.
2. The 'Shower Saver / Bath fill' button will flash.
3. The deluxe kitchen water controller 'Bath' indicator will flash.
4. A tone will sound.
5. The voice prompt will say "Bath fill is complete. Turn off the bath hot water tap and push the bath fill button."

Follow the voice prompts instructions. Note that the water heater will not allow hot water to flow from any fixture until the 'Shower Saver/ Bath fill'  button has been pressed.

6. The 'Shower Saver / Bath fill' button light on the Bathroom Controller and the 'Bath' indicator on the deluxe kitchen water controller monitor (when fitted) will go out.

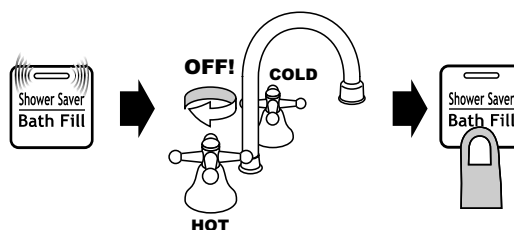
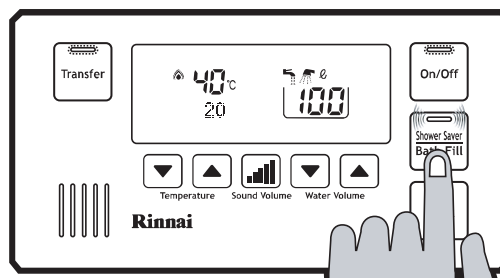
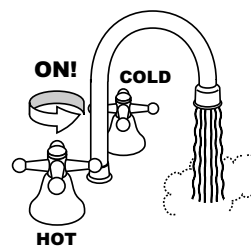

CHECK WATER TEMPERATURE BEFORE USE.

A parent or carer should always check the temperature before a child is placed in contact with hot water.

NEVER LEAVE YOUNG CHILDREN UNATTENDED IN THE BATH.

When using the 'Shower saver / Bath fill' function, ALWAYS close the hot water tap for the bath or shower after the flow has stopped.



Whilst hot water outlets are open the set temperature may be lowered. However they cannot then be raised above 43°C. In addition transfer of 'priority' between controllers is not possible. These are safety features.

USING MULTIPLE CONTROLLERS

The water heater can be turned on and off at any water controller. If more than one water controller is fitted press the 'Transfer'  button to transfer priority to the desired water controller.

COMBINING UNIVERSAL AND DELUXE CONTROLLERS

Universal and Deluxe Controllers can be combined and will function as described in other sections of the Water Heater Operation / Installation Manual. Refer to page 1 to confirm the maximum number and combination of water controllers that can be fitted to your water heater model.

WATER CONTROLLER INSTALLATION

WATER CONTROLLERS

Water Controllers are available as an optional extra. Universal and Deluxe Controller can be used together and will function as described in the Operation Section of this manual. Please refer to page 1 to confirm the maximum number and combination of controllers that can be fitted.



Other manufacturers water controllers are NOT compatible with Rinnai water heaters. These water controllers must not be used with any Solar Boost water heater.

Rinnai water controllers brought in from other countries are not compatible with Rinnai appliances sold in New Zealand.

POSITIONING OF WATER CONTROLLERS

Water controllers must be installed in shaded and clean locations. They should be fitted out of reach of children (suggested height from floor to be at least 1500 mm). BC-100V water controllers are water resistant, however, durability is improved when positioned outside the shower recess. All deluxe water controllers must be installed at least 400 mm above the highest part of a sink, basin or bath.



- Do not install water controllers near a heat source, such as a cook top, stove or oven. Heat, steam, smoke and hot oil may cause damage.
- Do not install water controllers in direct sunlight.
- The MC-100V water controller **MUST NOT** be installed in a bathroom.
- Do not install water controllers outdoors unless protection from dust ingress and sunlight are provided.
- Do not install water controllers against a metal wall unless the wall is earthed in accordance with AS/NZS3000.
- Water controllers **MUST NOT** be installed where chemicals such as benzene, alcohol, turpentine or other similar chemicals are in use.

POSITIONING CONSIDERATIONS FOR THE MC-100V WATER CONTROLLER.

The MC-100V uses a Liquid Crystal Display (LCD) for the digital monitor. Light reflections can make the LCD difficult to see at direct eye level.

For best results when installing the MC-100V mount the water controller lower than your eye-level to avoid these light reflections.

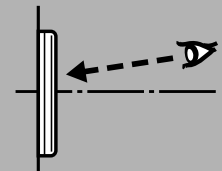

WATER CONTROLLER CABLES

Water controllers operate at extra low voltage (12 Volts DC) which is supplied from the water heater. Controllers come supplied with 15 m of electrical cable. The appliance end of the controller cables are fitted with spade terminals. Extension cabling is available from Rinnai.



Alternatively two core sheathed (double insulated) flex with minimum cross-sectional area of 0.5 mm² may be used. Maximum individual cable runs should not exceed 50 m.

FITTING THE 'DELUXE KITCHEN' WATER CONTROLLER (MC-100V)

1. Determine the most suitable position for the water controller (see note under "POSITIONING OF CONTROLLERS" on previous page).
2. Use the wall mounting bracket as a template to mark and drill 3 holes, locating the cable access hole as shown in Fig. 1.
3. Fix the mounting bracket to the wall using the appropriate fixings.
4. Run the water controller cable through the hole in the wall.

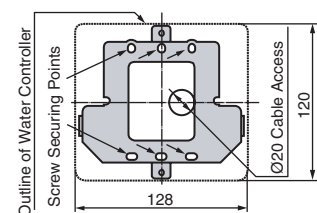

Fig.1

WATER CONTROLLER INSTALLATION

- Carefully remove face plate from water controller, using a screw driver. (Fig. 2)
- Connect the controller cable to the kitchen water controller as shown in Fig 3. At this point cables from other controllers (if fitted) may also be connected to the kitchen water terminals (Fig. 4) eliminating the need for multiple cable runs directly to the water heater. Water controllers are not polarity sensitive. Feed excess cable lengths into the wall cavity to avoid the pinching of cables between the wall and the water controllers.
- Fasten the water controllers to the wall mounting bracket as shown in Fig. 5. Avoid the use of impact drills and the over-tightening of fixings as this may damage the water controllers.
- Remove the protective plastic film from the water controller digital monitor.
- Replace the face plate.

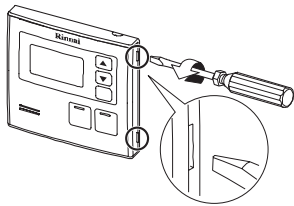

Fig. 2

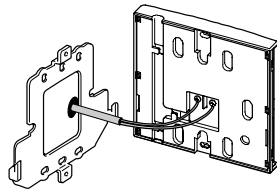

Fig. 3

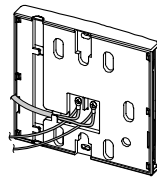

Fig. 4

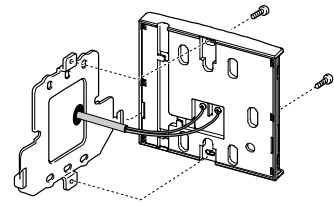

Fig. 5

FITTING THE 'DELUXE BATHROOM' WATER CONTROLLER (BC-100V)

- Determine the most suitable position for the water controller (see note under "POSITIONING OF WATER CONTROLLERS" on previous page).
- Mark and drill 3 holes, locating the cable access hole as shown in Fig. 1.
- When running a cable through the access hole ensure the connector end of the cable is located nearest to the controller. (Fig. 2)
- Affix the double sided self-adhesive seal to the back of the water controller. (Fig. 3)
- Carefully remove the face plate from the water controller, do this by placing your thumbs on the front of the digital display and while hooking your fingers behind top of plate and gently push as shown in Fig. 4, DO NOT use a screwdriver as this may damage the controller.
- Connect the cable to the bathroom water controller. Feed excess cable lengths into the wall cavity to avoid the pinching of cables between the wall and the controller.
- Fix the bathroom controller to the wall using the appropriate fixings as shown in Fig. 5, avoid the use of impact drills and the over-tightening of fixings as this may damage the water controller.

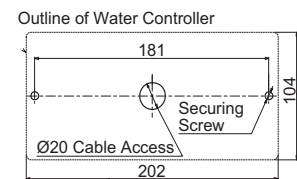

Fig. 1

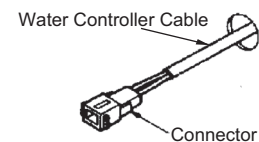

Fig. 2

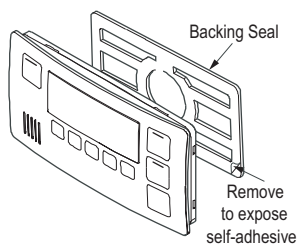

Fig. 3

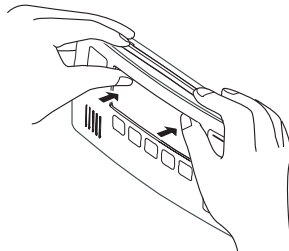

Fig. 4

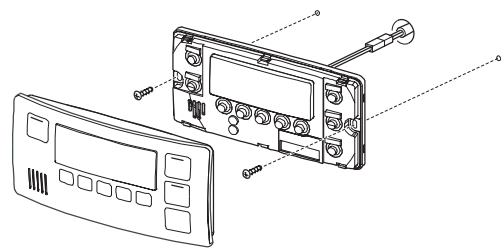

Fig. 5

- Remove the protective plastic film from the controller's digital monitor.
- Replace the face plate.

WATER CONTROLLER INSTALLATION

CONNECTING COMMUNICATION CABLES TO THE WATER HEATER

Communication cables connect the water heater to water controllers and operate at an extra low voltage (12 Volts DC) which is supplied from the water heater. Communication cables are supplied with the water controllers (15m) and are fitted with spade terminals for connection to water heater. Up to two cables can be connected directly to the cable connector at the water heater. Extension cables are available from Rinnai. Alternatively, two core sheathed (double insulated) flex with minimum cross sectional area of 0.5mm² may be used. Cable lengths must not exceed 20 metres.



DO NOT attempt to connect cables to the cable connector at the water heater unless the electric power to the water heater is switched 'off' otherwise damage to electrical components may occur.

To connect up to two cables to the cable connector

1. Isolate the electric power supply by switching the power point off and removing the power plug of the water heater from the electric power socket.
2. Remove the retaining screw (A) of the cable connector at the base of the appliance.
3. Swing the cable connector door open and thread the cable through the weather seal of the cable access hole (B) in the direction shown allowing sufficient cable length so that the sheath of the cable can be secured with cable clamp (C) supplied with the transceiver.
4. Loosen screw terminals (D) and (E) and connect the cable spade connectors to these terminals and re-tighten. Polarity is not important, either wire colour can be connected to either terminal.
5. Return the cable connector to the original position taking care not to damage cable wires in the process and replace the retaining screw (A).

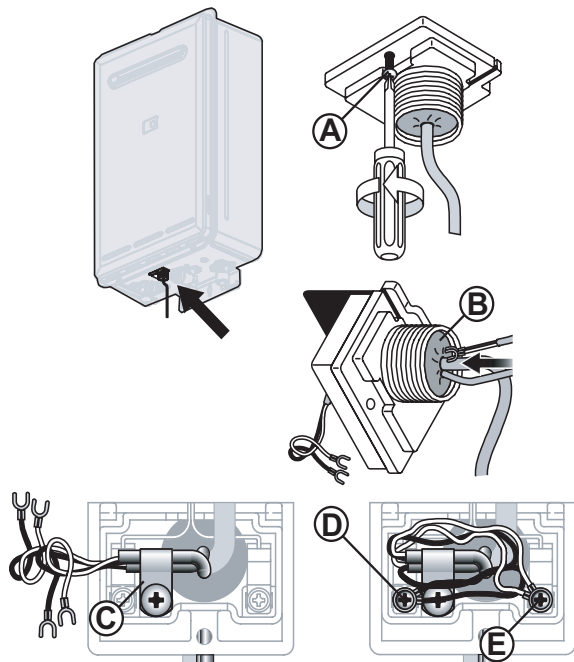

The cable connector for water heater models:
INFINITY XR26, XR24, XR20, XR18, XR16 and HD200

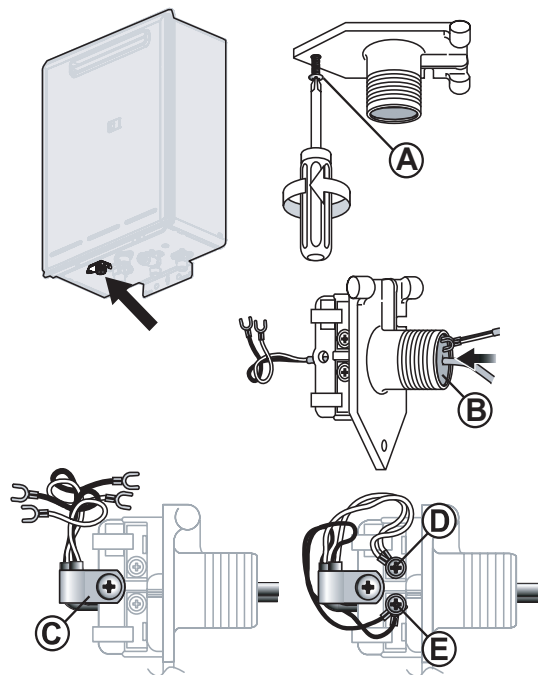

The cable connector for water heater models:
INFINITY XR32, XR26i, HD250, HD250i, HD200i, and Efficiency24

Connecting Three or Four Controllers

Repeat steps 1, 2 and 3 above.

To connect three or four cables, separate all the cables to be fitted into pairs. Cut off the existing spade connectors from each pair and re-terminate each pair into a new spade connector (available from your local electrical component retailer) (F) so that there are only two sets of spade connectors (4 spade connectors in total) to be terminated.

Repeat steps 4 and 5 above.

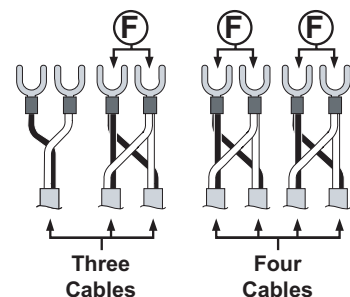

NOTES

NOTES

Rinnai

Customer Contacts

Consumer Enquiries: 0800 746624 (0800 RINNAI)

Installer Enquiries: 0800 86746624 (0800 TORINNAI)

Rinnai New Zealand Limited

691 Mt. Albert Road,
PO Box 24068 Royal Oak, Auckland
Email: info@rinnai.co.nz
www.rinnai.co.nz



060 00012 52829 9

U220-1149(00)
2008.01