

MODELS
CNTRLDRICIPB / CNTRLDRICIPW



Deluxe wired remote controllers
Operation and installation guide

Rinnai

Important

Controller must be installed in accordance with:

- Manufacturer's installation instructions
- Current AS/NZS 3000, AS/NZS 5141, AS/NZS 5419, AS/NZS 1677, and AS/NZS 60335.2.40
- HB276 - A Guide to good practice for energy efficient installation

Must be installed, maintained and removed only by an authorised person.

Warning

Improper installation, adjustment, alteration, service and maintenance can cause property damage, personal injury or loss of life.

For more information about buying, using, and servicing of Rinnai appliances call: 0800 RINNAI (0800 746 624).

Contents

Safety and important information..... 4

Installation 5

Controller operation

LCD Display..... 12

Controller buttons 13

Operation..... 14

Special functions setting..... 20

Fault codes 27

Wi-Fi control 28

Wi-Fi registration and connection 29

Safety and important information



DO NOT install the controller in a place exposed to leakage or flammable gases. Once flammable gases are leaked and left around the controller, fire may occur.

DO NOT operate with wet hands or let water enter the wired controller—electric shock may occur.

Controller must be wired according to the wiring diagram.

The wired controller operates in a low voltage loop circuit, DO NOT contact the cable to 220-240 V power.

The shielded wire of the wired controller **MUST BE** grounded.

After completing the wired controller connection, DO NOT use a megger tester to check the insulation. This may damage the product.

A maximum of TWO CONTROLLERS may be installed on a system.

Specification

Input voltage: DC 5 V / DC 12 V

Ambient temperature.: 0~43 °C

Ambient humidity: 40-90% RH

Controller loom shall be 2-core (0.5 mm²) shielded cable, up to 40 m.

Installation

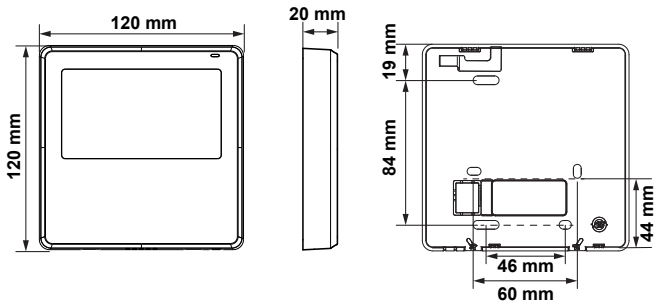

Backing plate

Remove the backing plate by inserting a flat screwdriver in the lower part of the controller, rotate (do not pry up and down) to remove the backing plate.

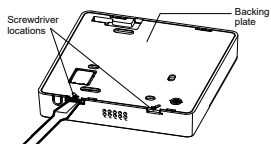

The PCB is mounted in the upper part of the controller, be careful not to damage.

Fasten the backing plate on the wall with three screws (ST3.9*25) and plugs (provided).

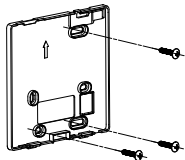

Loom access point

Remove plastic knockout from the backing plate.

Create a hole in the wall to access the wall cavity for routing the loom from the indoor unit to the controller.

Put on a flat surface. Be careful not to distort the back plate by over tightening the mounting screws.

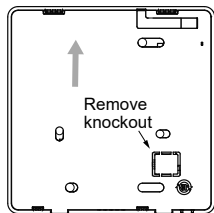

Battery installation (CR2032)



WARNING

Keep batteries out of reach of children.

Swallowing may lead to serious injury in as little as two hours, or death due to chemical burns and potential perforation of the oesophagus.

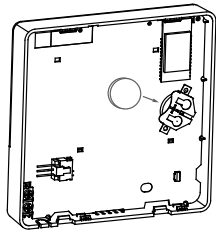

Slide the battery into the holder with the positive side facing up.

When first turning on set up the time of day. If the system is exposed to a power outage the battery will maintain the time of day. If the displayed time is not correct once power is restored try replacing the battery.

Thermostat connection to the indoor unit

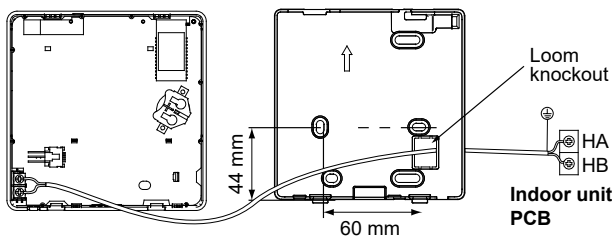

Indoor unit

Connect the terminals on the wired controller (HA, HB), and the terminals on the indoor unit (HA, HB). There is no polarity between HA and HB, refer image below.

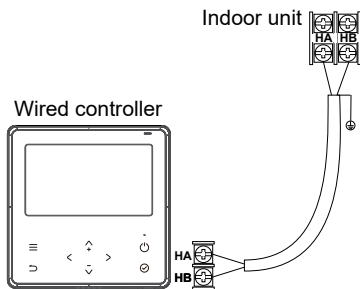

Setting up two controllers

Up to two controllers can be connected to the HA and HB terminals on the indoor unit as shown.

From the factory all controllers are supplied with SW1 dip switch setting 1 OFF and dip switch setting 2 OFF. When configuring a second controller, two dip switches on the rear of the second controller (SW1 location) must change to the ON position as shown. Dip switch settings for the primary controller must remain unchanged.

Controller 1 (primary)



Controller 2 (secondary)



If two controllers are installed both are equal and reflect the same information, and operational changes can be done on either controller. Wi-Fi control may be setup on one of the controllers only. There is no polarity between HA and HB.

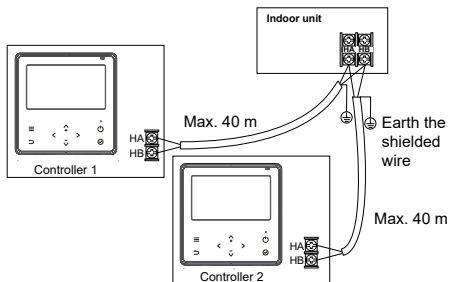

One controller to multiple units

For some units, one wired controller can support multiple units (a maximum of 16).

For configuration of multiple indoor units loom connection is polarity sensitive and HA must connect to HA on all indoor units, the same applies to HB. In group control there will be no error displayed on the wired controller.

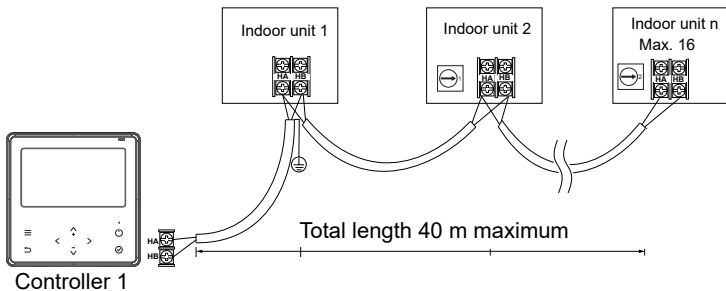

Reattach backing plate of the wired controller

To reconnect the fascia to the back plate, anchor the top lugs first as shown below then swing the fascia down and press lightly to engage the bottom tabs. Be careful not to pinch the loom during the process.

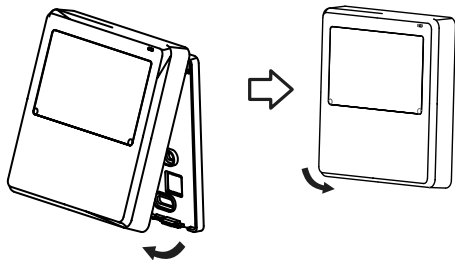

DO NOT allow water to enter the controller, use trap and putty to seal the connectors. Connecting wires must be securely fixed in place.

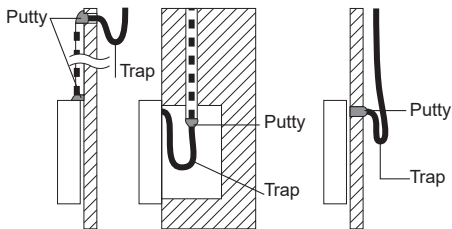

Controller operation



Functions

- Mode: Auto-Cool-Dry-Heat-Fan
- Fan speed: Auto/Low/Med/High
- Timer ON/OFF
- Temperature setting
- Weekly timer
- Follow me
- Turbo
- Child lock
- Clock

LCD display

MODE display
Displays the current mode, including:



AUTO COOL DRY HEAT FAN

Function display

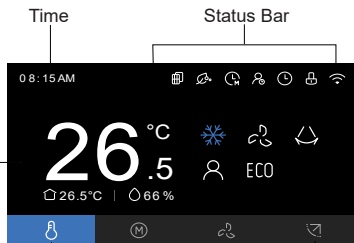

FAN SPEED display
Displays selected fan speed:

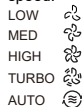

- Child lock
- Temperature
- Mode
- Warning
- Function
- Active clean

- Wireless control
- Room temperature
- Follow me
- ECO
- Filter cleaning reminder
- SLEEP

- Choose
- Timer
- Set up
- Timer settings
- Delay off
- Vertical louver swing
- Horizontal louver swing

Controller buttons

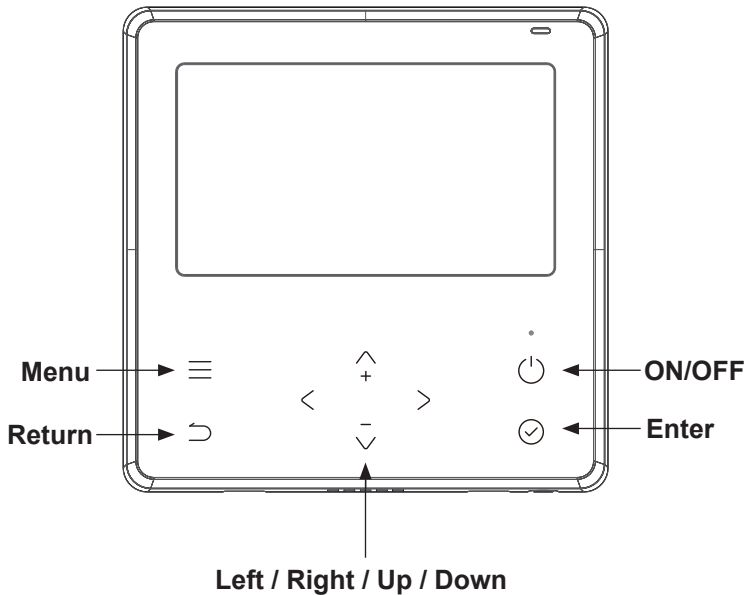

Operation

To start press the power button on the controller. The main page display will appear.



Power-on status
main page display



Power-on status
main page display



Shutdown status
main page display



Shutdown status
main page display

Standby and screen off

Standby occurs after 30 seconds if no button is pressed. After entering the standby state, the controller exits all setting states and restores the main page display.



Screen off occurs after 60 seconds if no button is pressed. Press any key to return to the home page screen.

Date and time setting

The lower section of date and time setting can be set to 12/24 hour system switching, wired controller time setting or wired controller date setting.

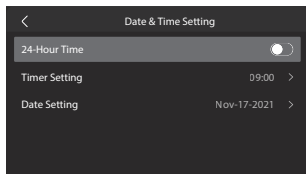

The time, and date setting interface on the wired controller is as follows:

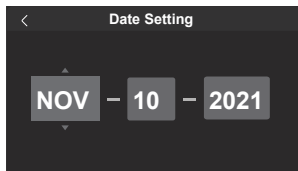
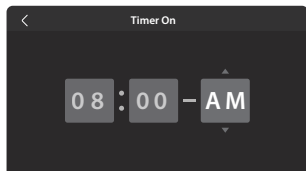

°C / °F setting

Press the up and down buttons for three seconds will alternate the display between °C and °F.

Mode setting (M)

1. Press the left or right buttons to select 'Mode'.

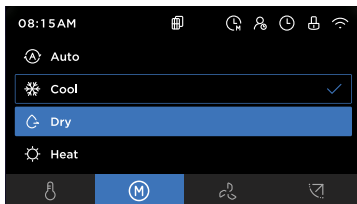

2. Press the up or down buttons to select the mode of operation and press the enter button (tick) to adjust the settings.

If Auto or Dry mode is selected, the fan speed is fixed and cannot be adjusted—the set temperature is adjustable.

If Cool or Heat mode is selected, the fan speed and temperature can be adjusted.

When in Fan mode, the temperature display will be greyed out, the temperature cannot be adjusted.

Set temperature setting

Press the up or down buttons to set the room temperature. Setting temperature range 10/16/17~30 °C or 20~28 °C (model dependent).

Fan speed setting

Press the left or right buttons to select 'Fan'. Fan speed is unavailable in 'Auto' or 'Dry' modes. Press the up or down buttons to select the fan speed and then press enter (tick) to change the fan speed.

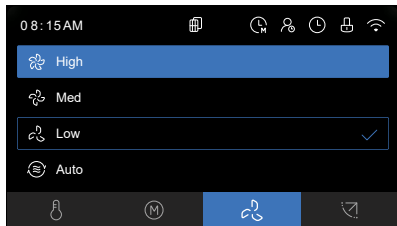

Press the up or down buttons to select customised fan speed, then press enter (tick) to enter stepless fan speed. In stepless fan speed press the up or down buttons to adjust. The range is 1~100%. Press return to exit.

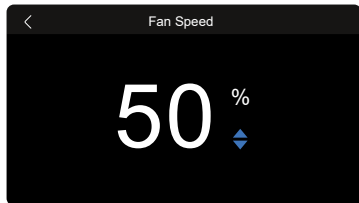

Fan direction setting (model dependent)

Press the left or right buttons to select louver swing.

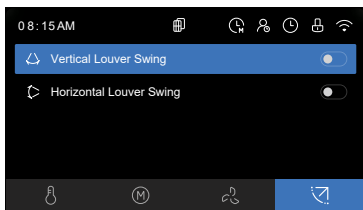

Press the up or down buttons to select the fan direction function, press enter (tick) to enable or disable the function.

When the horizontal louver swing is selected, press enter (tick) to enable/disable the horizontal swing function.

When the vertical louver swing is selected, press enter (tick) to enable/disable the vertical swing function.

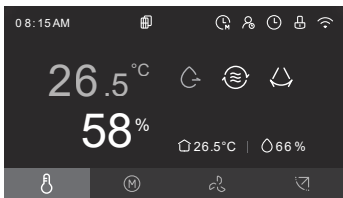

Special function settings

Turbo

This mode allows you to cool indoor air quickly in summer or warm it quickly in winter. In turbo mode the fan is set to operate at the maximum output.

Menu > up or down buttons > function icon > enter > turbo turn on
The turbo wind speed icon on the home page is displayed.



Follow me

When follow me is activated the room temperature is detected at the sensor in the wired controller. When follow me is not active the room temperature is detected at the air inlet of the indoor unit.

Menu -> up or down buttons -> function icon -> enter -> follow me. The follow me icon on the home page is displayed.



ECO (available under cool mode only)

Under cooling mode press ECO, the controller will adjust the temperature automatically to 24 °C with a fan speed of auto to save energy. Modifying the mode or adjusting the set temperature less than 24 °C will stop the ECO operation. Under ECO, the set temperature should be 24 °C or above, it may result in insufficient cooling. If you feel uncomfortable press the ECO button again to stop it.

Menu -> up or down buttons -> function icon -> enter -> ECO



Sleep

This function gently regulates the set temperature to prevent excessive, draft free, heating or cooling during sleep. It allows the set temperature to increase or decrease 0.5-1 °C in an hour, up to a maximum of 2 °C above or below the set point (over a 10 hour period). The fan is on auto.

Menu -> up or down buttons -> function icon -> enter -> Sleep



Special function setting (model dependent)

This allows additional controls depending on the parameter selected. What is available will be dependent on the indoor model.

Menu -> up or down buttons -> function icon -> Smart Control / Timer / or System settings -> enter or right button to enter next menu -> up or down buttons to adjust parameters -> enter



Child lock

Menu -> function icon -> enter, there will be a second confirmation prompt -> enter

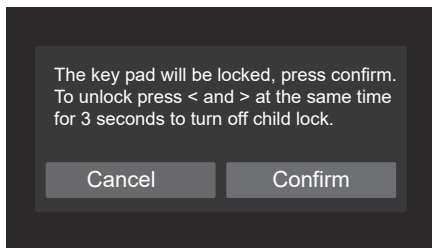

Filter cleaning reminder

To enable this function:

Menu -> up or down buttons to select settings -> enter -> turn on filter cleaning reminder, the filter symbol lights up.

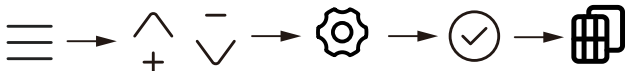

Active clean

Menu -> up or down buttons -> function icon -> enter -> turn on active clean



The unit will enter an automated process where the indoor unit coil will be cleaned and sterilised. This function can take up to 90 minutes to complete.

Active Clean should be done at least twice a year, at the end of summer, and at the end of winter. This does not replace the requirement for yearly servicing of your unit. Contact your installer or Rinnai to schedule annual servicing.

Daily timer

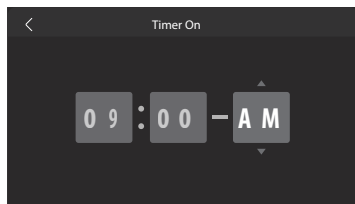
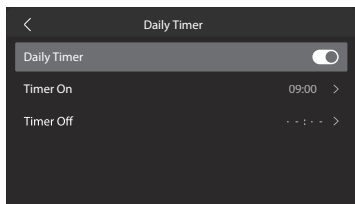

Weekly timer

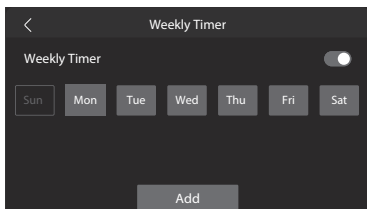
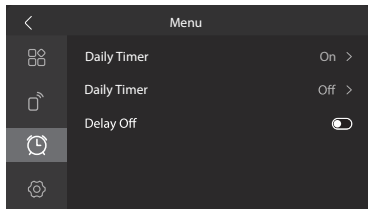

Use the up or down buttons to select the timer day, and use ADD to add the set time, timer on, timer off, temp, mode, and fan speed.

Weekly timer continued

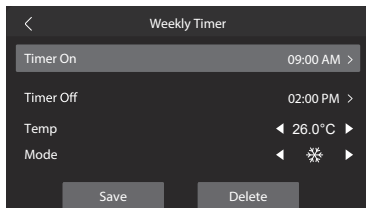
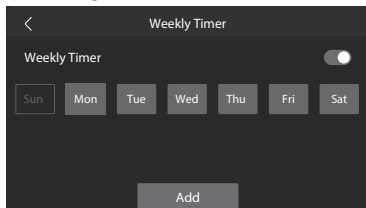

Once the first timer has been added and saved there will be a 'Copy Timer' option available for additional days.

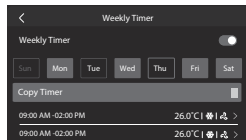
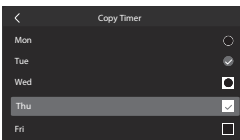
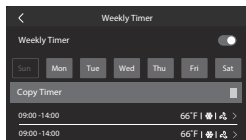

Delay off

Menu -> up or down buttons -> timer function -> turn delay off

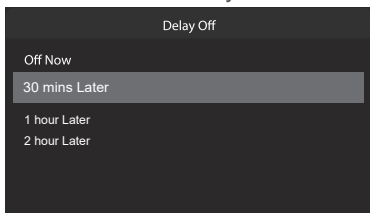
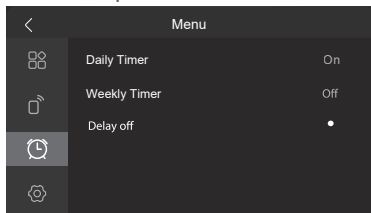

The delay off setting has a power-down memory function. When the delay off has been activated, when the timer function is pressed, a reminder of the delay off function will pop up.

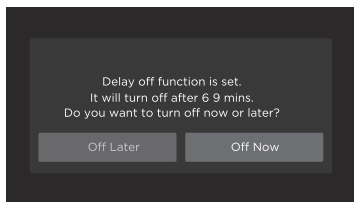

Fault codes

There are a number fault / error codes that could show on the controller. For a full list of what these are refer to the installation guide, available online at www.rinnai.co.nz. There is one error code that relates to a communication error between the wired controller and that of the indoor unit, this is **EH63**, this will require a service call.

Wi-Fi control

The system comes with Wi-Fi capability as standard, which features Wi-Fi control via an App.

Simple to activate and easy to use, the 'NetHome Plus' App can be downloaded via Google Play or the App store on a compatible mobile device.

Your home's Internet router relays requests from the App to control your air conditioner, just like your normal remote controller.

Set your favourite temperature before you come home. Available to download via:

- Google Play
- App Store



Please note



NetHome Plus is a third party App not run by Rinnai.

For this App to run the home's Internet router must be running on 2.4 GHz (not 5 GHz)—check the Wi-Fi settings on your device.

Wi-Fi registration and connection

As technology and App updates are frequent it has not been placed in this guide. If you are registering and connecting using the Wi-Fi App, please refer to the online user guide available on the Rinnai NZ website. Just enter 'NetHome Plus app' in the search field.

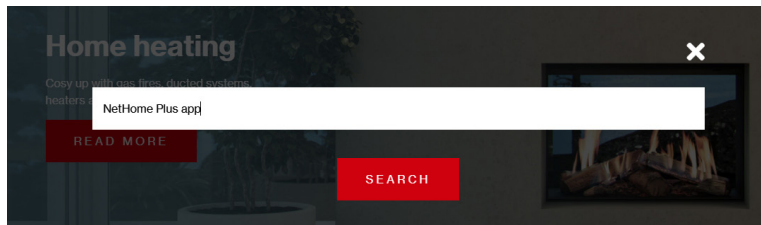

The steps to register and connect are:

1. Download and install the NetHome Plus App on a compatible mobile device
2. Complete an App registration by creating an account, this must be done in the home
3. Pair your mobile device to the unit via the home router

Please note:

When connecting the device you must finish all the steps in **eight minutes** after powering on the unit, otherwise you'll need to switch the unit off and go through the process again.

Notes

Notes

Rinnai.co.nz

Tel: 0800 746 624

<http://www.youtube.com/rinnainz>

<http://facebook.com.rinnainz>

R32 deluxe controller op & install guide
15130-B I 02-23