



Novo Inbuilt gas fireplaces

Specification guide

Rinnai

Important

Rinnai is constantly improving its products, and as such, information and specifications are subject to change without notice. For the most up-to-date information, go to www.rinnai.co.nz.

Help is here

For more information about buying, using, and servicing of Rinnai appliances call 0800 RINNAI (0800 746 624).

Rinnai New Zealand Limited
105 Pavilion Drive, Mangere, Auckland
PO Box 53177, Auckland Airport, Auckland 2150

Phone: 09 257 3800
Email: info@rinnai.co.nz
Web: www.rinnai.co.nz
www.youtube.com/rinnainz
www.facebook.com/rinnainz

Contents

Novo Inbuilt specification.....	4
Novo Inbuilt unit dimensions (mm)	5
Novo Inbuilt positioning	6
Novo Inbuilt enclosure dimensions (mm)	7
Novo Inbuilt accessories.....	8
Novo Inbuilt flueing options	9
Novo Inbuilt flue kits and components.....	10
Novo Inbuilt ordering guide.....	12

Appendix 1

Flooring and hearth material selection	13
--	----

Appendix 2

Running costs.....	14
--------------------	----

Novo Inbuilt specification

A direct vent (room sealed) inbuilt gas fireplace with a glass front and convection fan, pushing warm air from the top of the appliance. Operated using a simple IR remote to control flame height and fan speed, or by the Rinnai Wi-Fi app (optional accessory) that allows full thermostatic control, as well as other features such as timers.

Input: 14-30 MJ/h
 Output: 3.6-6.6 kW*
 Efficiency: 77%
 Heating area: 65-112 m²**
 Gas type: NG or ULPG

* Will vary according to gas type and flue configuration

** Will vary depending on location in NZ



Suitability	Suitable for masonry, or mock chimney installations, in open plan areas and living rooms. As a room sealed appliance it can also be installed in larger bedrooms if this meets 6.10.6.1 requirements of AS/NZS 5601.1.
Installation considerations	Consider the room size. Smaller rooms will heat up quickly, and due to the heat of the appliance, the fire will reduce to a low flame setting once the set temperature has been reached.
Frame options	Standard, or classic bronze frame.
Data plate position	Lower RHS of the base panel
Convection fan	120 V AC 50 Hz 2-speed centrifugal blower
Gas connection	Brass ½ “ BSPT male fitting. The gas supply terminates inside the unit—lower RHS of the appliance.
Ignition	230-240 V AC 50 Hz high voltage electronic spark generation.
Flueing	The Novo must be installed with a Rinnai approved direct vent flue system. The two flue systems are: Masonry chimney: Colinear ¹ DV flexi flue, air intake Ø75 mm, exhaust Ø100 mm Mock chimney: Coaxial ² DV flue, inner Ø100 mm, outer Ø170 mm
Noise level	37 - 45 dB(A)
Electrical	1.5 m power cord with a 3-pin plug is supplied. The power cord passes through a slot in the back left hand corner of the appliance. High - 50 W, standby - <3 W
Safety devices	Flame failure sensing system, pressure relief, overheat safety switch, air temperature sensor, thermal fuse, overcurrent fuse, and spark detection.
Weight	64 kg

¹ Colinear: Uses TWO separate flexible aluminium chimney liners as the flue system

² Coaxial: One flue, the exhaust flue is nested inside the air intake flue—these are rigid flues



Colinear

Coaxial

Novo Inbuilt unit dimensions (mm)

Coaxial in timber

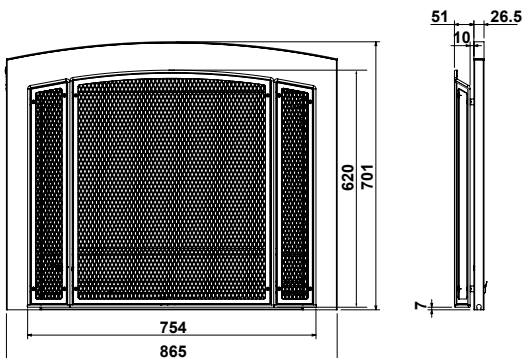
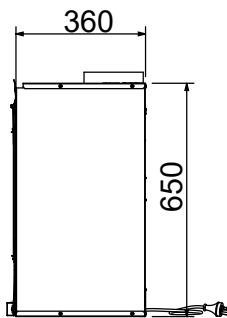
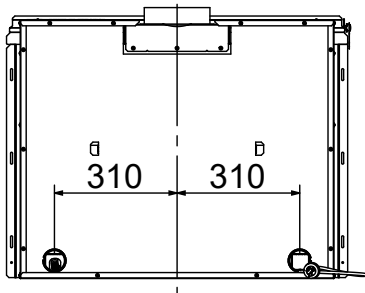
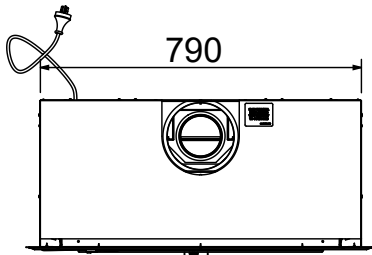
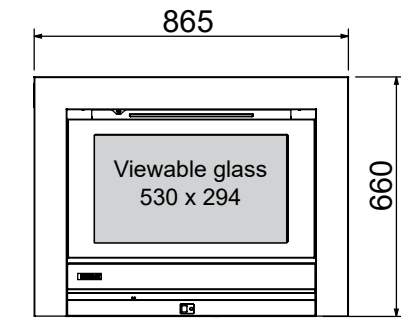

Colinear in masonry

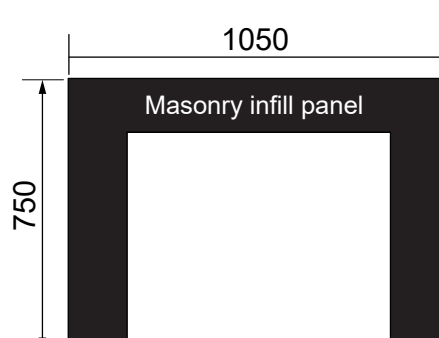
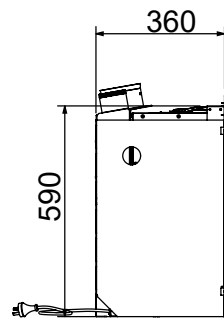
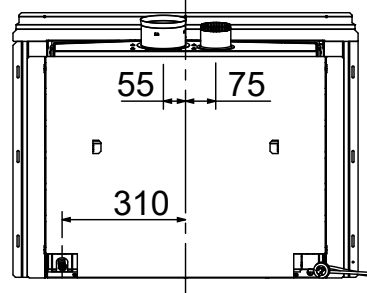
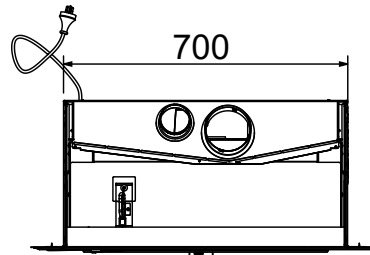
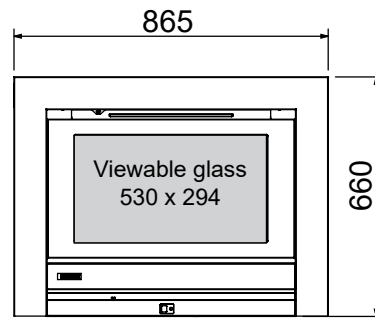

Novo Inbuilt positioning

Combustible clearances

The Novo must not be installed where curtains, furniture, or other combustible materials could come into contact with the fire while it is operating. The 400 mm side clearance, measured from the edge of the glass, includes side walls. The 1000 mm clearance is in front of the fire.

Hearths

A hearth is not necessary but can be used for decorative purposes. It must not obscure the front of the fire or obstruct the fire in any way.

Flooring and hearth material selection

The temperature in front of the Novo can reach up to 40 °C above ambient, which is why material selection is important. For example we know that vinyl planks are only rated for ambient temperatures, the Novo would not be suitable in this instance for installation directly on the floor. For more information and guidelines about material selection, refer p.13.

Floor protection

Heat radiating from the fire may affect the appearance of some materials used for flooring such as vinyl planks (as mentioned above), carpet¹, cork, or timber. To avoid this occurring it is recommended a mat be placed in front.

¹ Carpet cannot be fitted hard up against the fire as it will affect operation.

Mantles and surrounds

Combustible mantels and surrounds require clearance from the unit to minimise the risk of fire. They are allowed providing they are outside the minimum clearances shown.

The Novo gas fireplace is not designed to be built into bookcases.

TV installation

The Novo has a fan that distributes warm air from the top of the appliance out into the room. As warm air is dispersed outwards and not directly upwards, installation of a TV may be an option. For more information refer to the Novo Inbuilt installation guide.

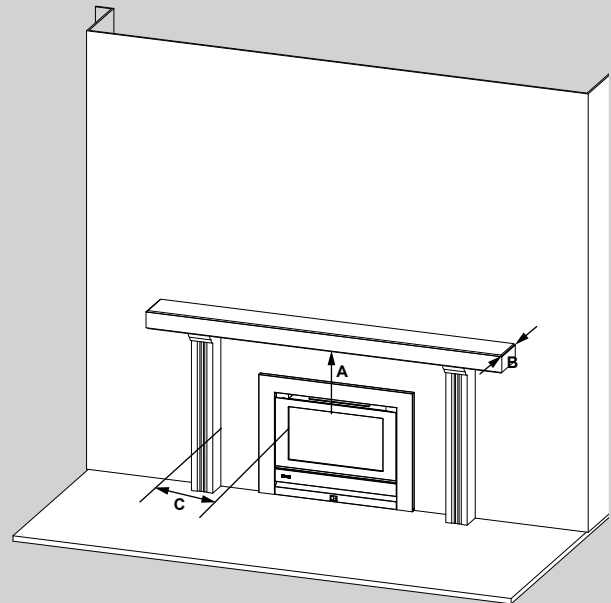
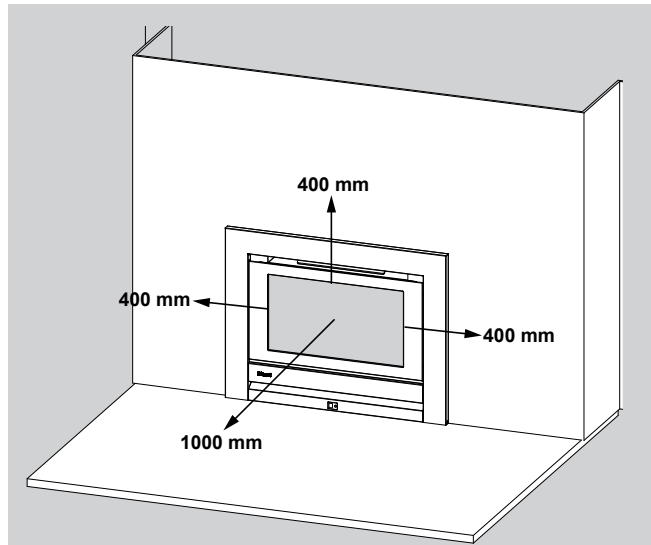

- A** Mantel needs to be a min. of 400 mm away from the edge of the glass
- B** Max. mantel depth at 400 mm (A) is 250 mm
- C** Surround needs to be a minimum of 150 mm away from the edge of the glass

For every 50 mm of added mantel depth there must be an additional 100 mm of clearance from the edge of the glass. For example:

Mantel depth	Vertical clearance req. (A)
300 mm	500 mm
350 mm	600 mm
400 mm	700 mm

Novo Inbuilt enclosure dimensions (mm)

The Novo must be positioned within the enclosure on a level surface that allows free movement of the appliance. The enclosure must be capable of supporting 1.5 times the weight of the unit.

MASONRY

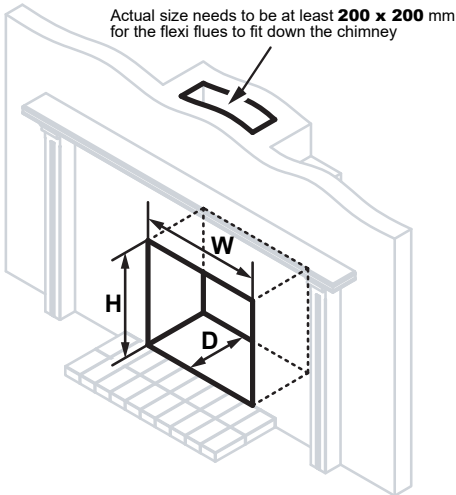

Enclosure dimensions		With infill panel
W-width	700 mm	700-1030 mm
H-height	600 mm	600-740 mm
D-depth	370 mm min.	370 mm min.

Enclosure dimensions can be larger if using an infill panel. This is a panel for masonry installations where the cavity is slightly larger than the frame.

MOCK CHIMNEY

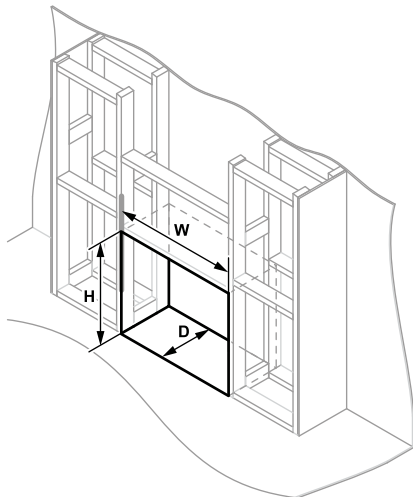

Enclosure dimensions	
W-width	800 mm
H-height	655 mm
D-depth	370 mm min.

This installation has a zero clearance box (comes with the fire). The total cavity depth must also include the thickness of the external cladding as the zero clearance box front flange is set forward to allow the wall lining and flange to be flush when finished.

CORNER INSTALLATIONS

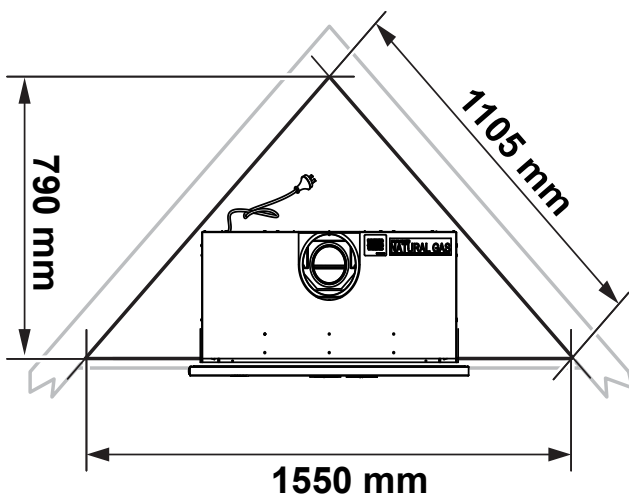

Novo Inbuilt accessories

Novo Inbuilt classic bronze frame R2380

Designed to complement older villa style homes. The classic frame is curved and comes with a inset bronze dress guard and a black inner frame.

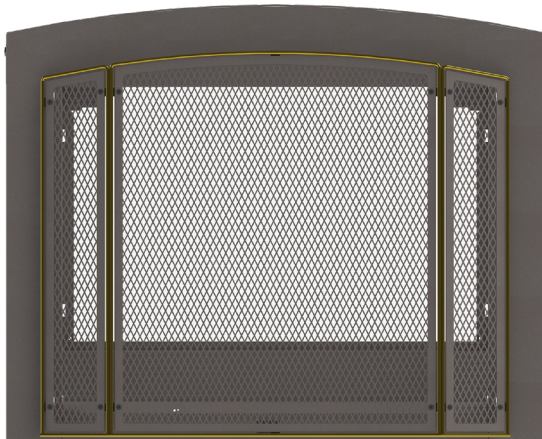

Novo Inbuilt mesh frame R2370

The Novo Inbuilt black mesh frame is an accessory for the Novo black standard frame. The black integrated mesh guard can be easily installed, no fixing required. It is designed to protect against touching the hot surface of the glass¹.

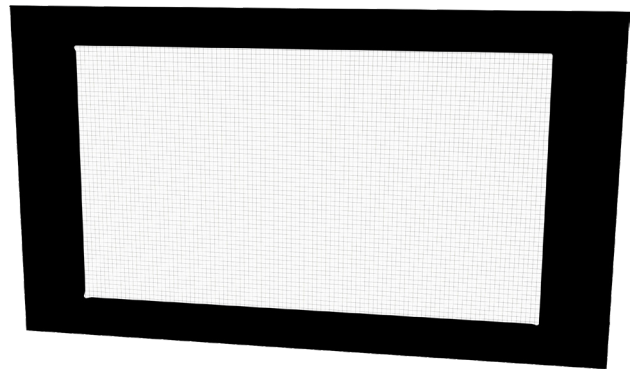

Novo Inbuilt masonry infill panel R2373

Black powder coated panel for masonry installations where the cavity is slightly larger than the frame. The panel will cover the gap behind the fire and the standard rectangular frame. It is not suitable for use with the classic bronze frame.

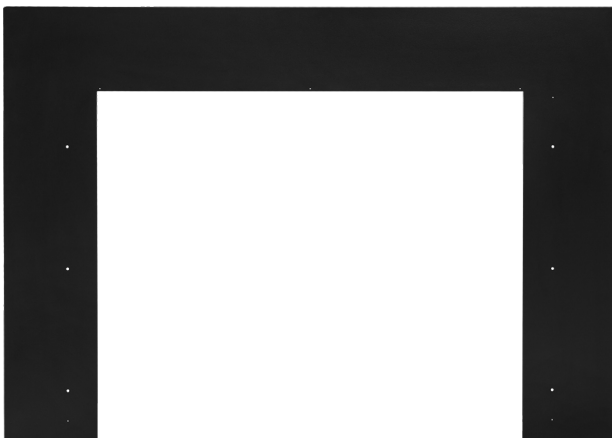

Wi-Fi module retrofit kit R7000

The Rinnai R7000 Wi-Fi board retrofit kit enables the fire to be connected to the Rinnai Fire Wi-Fi App for full thermostatic control, as well as other features such as timers. Ideally fitted at the time of installation.



¹ The mesh will still get very hot—it is not a fire guard

Novo Inbuilt flueing options

Every gas fire requires a flue system that will draw effectively and clear flue products safely under all potential wind and climatic conditions. It is the responsibility of the installer to ensure the appliance is provided with an effective flue.

The Novo MUST BE installed with a Rinnai approved flue system, approved components are shown in this guide.

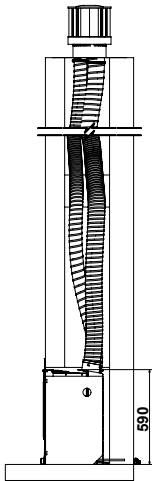

Masonry vertical

Colinear aluminium flexi flues with a Duravent cowl.

For installations in a masonry fireplace. Extends out to 5.5 m. If longer flueing is required then the colinear flexi flue extension kit needs to be ordered.

- Minimum flue length - 3 m
- Maximum flue length - 8 m

Flue components

R3656

Masonry flue kit vertical 5.5 m DV.

R3657

Masonry vertical flexi flue extension kit 2.5 m DV.

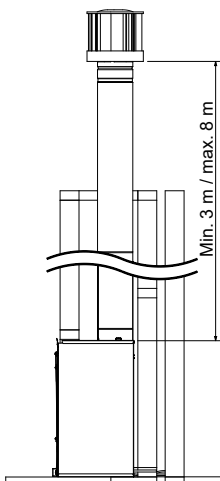

Mock chimney vertical straight

Coaxial flue with a Duravent cowl.

For installations into a combustibile opening, where the flue runs vertically in-wall and terminates vertically.

If doing a short vertical flue (no bends) for a single storey dwelling, the mock chimney vertical flue kit 3.6 m can be used otherwise the flue components can be ordered separately.

Flue components

R3665

Coaxial vertical flue kit 3.6 m.

Individual components

1. Flue pipes or flue extension, refer p.10.
2. Roof cowl (R3651)

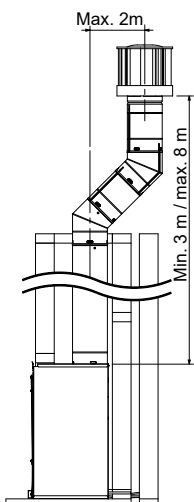

Mock chimney vertical offset

Coaxial flue with a Duravent cowl.

For installations into a combustibile opening, where the flue runs vertically in-wall, offsets with 45 degree bends and terminates vertically.

- Maximum number of 45° bends is two

There is no flue kit for this installation, individual flue components are required.

Flue components

Individual components

1. Flue pipes or flue extension, refer p.10.
2. Flue elbow 45° (R3642)
3. Roof cowl (R3651)

Novo Inbuilt flue kits and components

Masonry flexi flue kit vertical 5.5 m DV

Code: R3656

For installations in a masonry fireplace. Extends out to 5.5 m. If longer flueing is required then the colinear flexi flue extension kit needs to be ordered.

Kit includes:

- aluminium colinear roof cowl DV
- chimney plate 455 x 455 mm
- intake flexi Ø75 mm (LHS)
- exhaust flexi Ø100 mm (RHS)
- 2 x Ø75 mm flue clamps stainless steel
- 2 x Ø100 mm flue clamps stainless steel

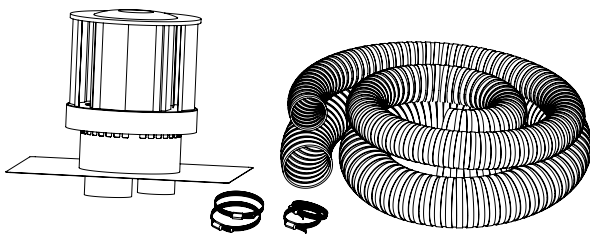

Masonry flexi flue extension kit 2.5 m DV

Code: R3657

When flueing needs to extend beyond 5.5 m.

Kit includes:

- intake flexi Ø75 mm (LHS)
- exhaust flexi Ø100 mm (RHS)
- 2 x joiners
- 2 x Ø75 mm flue clamps stainless steel
- 2 x Ø100 mm flue clamps stainless steel

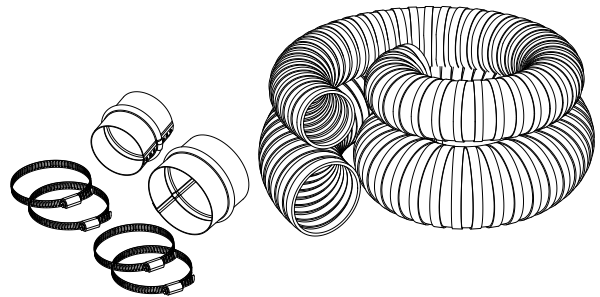

Coaxial vertical flue kit 3.6 m DV

Code: R3665

For installations in a mock chimney installation.

Kit includes:

- coaxial vertical roof cowl (R3651)
- 3 x 1200 mm flue pipes (R3636)
- 2 x wall straps (R3647)

If longer flueing is required order additional lengths of flue pipe.

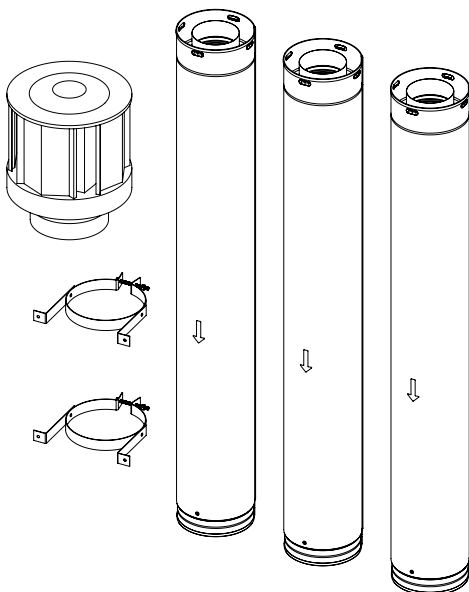

Coaxial vertical flue cowl DV

Code: R3651

Aluminium flue terminal required for all coaxial vertical flue installations.

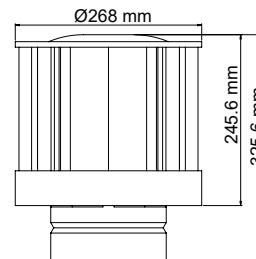

Coaxial flue pipe extensions

Code: R3638 75-175 mm

Code: R3639 75-360 mm

Used for extended straight lengths of flue. Available in two lengths. Cannot be cut to size.

- Inner aluminum Ø100 mm
- Outer galvanised steel Ø170 mm

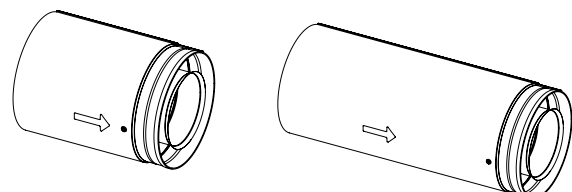

Novo Inbuilt flue kits and components

Coaxial flue pipes DV

Interlocking. CANNOT be cut to size.

Once joined nominal length reduces approximately 35 mm.

- Inner: Aluminium Ø100 mm
- Outer: Galvanised steel Ø170 mm

150 mm	R3630
230 mm	R3631
300 mm	R3632
450 mm	R3633
600 mm	R3634
900 mm	R3635
1200 mm	R3636

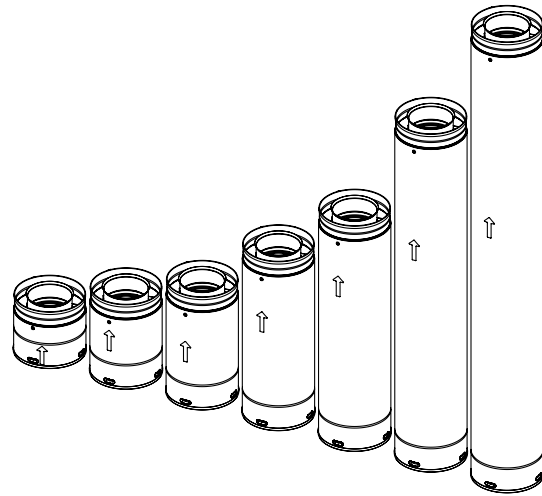

Coaxial 45° flue elbows (two bends in a kit)

Code: R3642

Offsets obstructions. Elbow swivels 360° at base. Angle not adjustable. Once joined effective length reduces 35 mm to approx. 73 mm.

Inner: Aluminium Ø100 mm
Outer: Galv. steel Ø170 mm

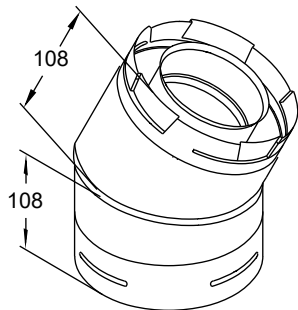

High wind vertical cowl protection kit

Code: R3655

For windy areas such as Wellington, coastal properties, or elevated properties on hills. Designed to wrap around the vertical cowl (as pictured) to reduce wind entering the flue and causing disturbances. It is fitted to the cowl and can be retrofitted.

Construction - stainless steel

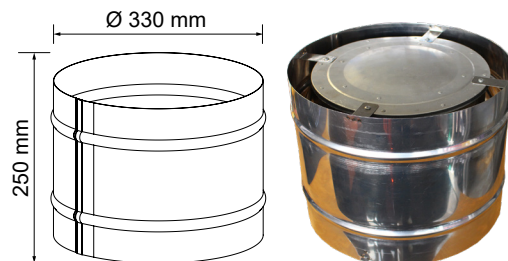

Wall strap DV

Code: R3647

Adjustable strap used in installations to add lateral support to the flue.

Provides a 50-200 mm clearance to combustibles.

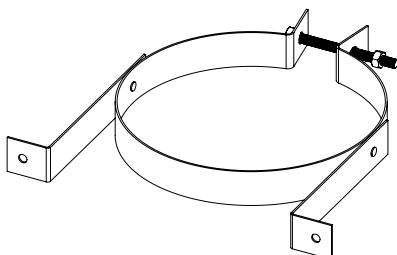







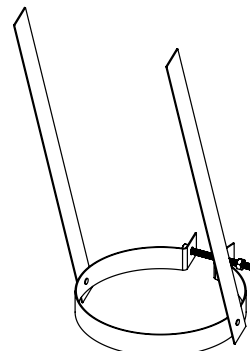





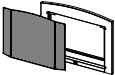
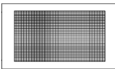

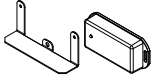
Elbow flue strap DV

Code: R3644

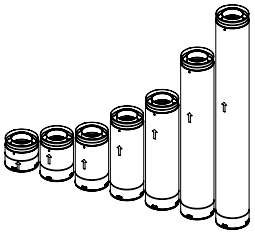
Flue supports for elbows and offsets. Strap length approximately 432 mm.



Novo Inbuilt ordering guide

1. Select installation and gas type		Code
Masonry installation		
	Novo Inbuilt masonry NG	RDV2320MN
	Novo Inbuilt masonry LPG	RDV2320ML
Mock chimney (combustible opening)		
	Novo Inbuilt combustible NG	RDV2320CN
	Novo Inbuilt combustible LPG	RDV2320CL
Supplied with the following: flue adapter, zero clearance box, standard outer frame, IR remote, stainless steel gas pipe, brass adapter, aeration plates and screws, log set and granules.		
2. Select optional accessories		
	Novo Inbuilt classic bronze frame	R2380
	Novo Inbuilt mesh frame	R2370
	Novo Inbuilt masonry infill panel	R2373
	Wi-Fi module control kit	R7000
3. Select flue components		
Masonry flue components		
	Masonry vertical flexi flue kit 5.5 m	R3656
	Masonry vertical flexi flue ext kit 2.5 m	R3657
Mock chimney flue components		
	Flue kit DV vertical 3.6 m (If you need to order the flue cowl separately the part is R3651)	R3665
	Flue pipe 150 mm	R3630
	Flue pipe 230 mm	R3631
	Flue pipe 300 mm	R3632
	Flue pipe 450 mm	R3633
	Flue pipe 600 mm	R3634
	Flue pipe 900 mm	R3635
	Flue pipe 1200 mm	R3636
	Flue pipe extension 75-175 mm	R3638
	Flue pipe extension 75-360 mm	R3639
	Coaxial 45° flue elbows (two bends in a kit)	R3642
	Elbow flue strap	R3644
	Wall flue strap	R3647
	High wind vertical cowl protection kit	R3655

Appendix 1:

Flooring and hearth material selection

The temperature in front of the fire (200-350 mm x 400 mm wide) can reach up to 40 °C above ambient, which is why material selection is important, some guidelines are detailed below. For example we know that vinyl planks are only rated for ambient temperatures which is why the fire would not be suitable for installation directly on the floor.

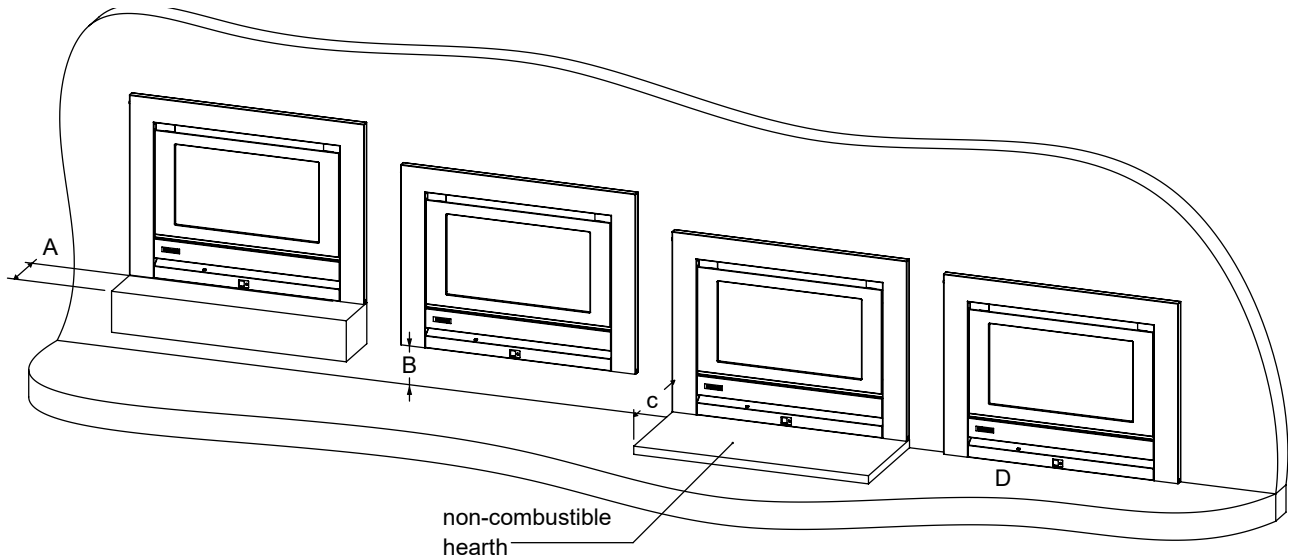

Dim.	Non-combustible materials or materials rated to 60 °C or higher above ambient	Materials rated to a maximum of 50 °C above ambient	Unrated materials, rated up to 20 °C above ambient
A	No maximum.	150 mm maximum ¹	100 mm maximum ¹
B	No minimum	150 mm minimum	300 mm minimum
C	No minimum	400 mm minimum of non-combustible material	450 mm minimum of non-combustible material
D	No restriction	Not suitable for carpets or any heat sensitive materials	

¹ Refer floating hearth section below

Just because a material is rated >60 °C doesn't mean it will not deteriorate when exposed to heat cycles. Always refer to the materials supplier for suitability. The temperatures given are assuming the fire is operating in a room temperature of no more than 25 °C. Operation in higher ambient temperatures may result in higher surface temperatures. Non-combustible materials should be made of heat resistant material.

Floating hearth - low rated and unrated flooring materials

For unrated flooring materials, if you use a non-combustible floating hearth, the dimensions of the hearth, minimum depth, and minimum height, can be tweaked using the following calculations:

- Min. hearth depth (A) = 450²-height of hearth (for 50 °C rated materials it will be 400)
- Min. hearth height = 450²-depth of hearth (for 50 °C rated materials it will be 400)

Example

If you wanted a 200 mm deep non-combustible hearth, the calculation for hearth height would be: 450 - hearth depth (A) (450-200 = 250). The non-combustible hearth height would need to be 250 mm minimum.

This would mean the floating hearth dimensions could be 200 mm deep and 250 mm high.

² Figure obtained from in-house temperature testing

Appendix 2:

Running costs

45 kg LPG gas bottle energy calculation

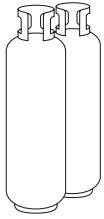

1 kg of LPG gas contains 50.4 MJ of energy
1 kW = 3.6 MJ

This means that a 45 kg LPG bottle has approximately 2268 MJ (45 kg x 50.4 MJ)

Natural Gas: Calculating your own running costs

- 1 Calculate the MJ input of the appliance to kW, for example 14 MJ/h = 3.89 kW/h
- 2 Calculate the approximate running cost per hour, for example $\$0.1414 \times 3.89 \text{ kW/h} = \$0.56/\text{hr}$

LPG: Calculating your own running costs

- 1 Calculate the cost of gas per MJ/h, for example; $\$115 \div 2268 \text{ MJ} = \0.051 per MJ/h
- 2 Calculate the approximate running cost per hour, for example $\$0.051 \times 15 \text{ MJ/h} = \$0.76/\text{hr}$

LPG and Natural Gas costs

Natural gas

It's become a competitive market out there and we're noticing that plans and pricing are more difficult to access without actually switching providers. Natural Gas costs are based on the latest MBIE¹ natural gas residential cost as at 2021, which includes GST and a daily fixed line charge. It doesn't include any prompt payment discount.

- MBIE residential - 0.1441 cents/kWh

¹ www.mbie.govt.nz/building-and-energy/energy-and-natural-resources/energy-statistics-and-modelling/energy-statistics/energy-prices/

LPG (as at May 2022)

To fill a 45 kg gas bottle we found the below numbers, we have averaged this at \$109 and used this number to calculate running costs.

- frank energy - \$104 Dual Fuel Plan or \$120 Single Fuel Plan
- Vector Ogas - \$110.46 (range on website \$110.46-\$180.82)
- Trustpower - \$102

Above figures exclude LPG bottle rental.

The cost of LPG and Natural Gas will differ in each area, please check with your local supplier. The cost of the cylinder rental, line charges and other variables are not included in the running costs.

Novo hourly running costs

LPG running costs per hr.		NG running costs per hr.	
on low	on high	on low	on high
\$0.67	\$1.30	\$0.56	\$1.20

Novo 45 kg LPG bottle run hours and weekly running costs

Gas input				45 kg bottle will last (hours)		Weekly running costs (\$)			
Low		High				LPG		Natural Gas	
MJ/h	kW	MJ/h	kW	Low	High	Low	High	Low	High
14	3.89	30	8.33	162	76	\$23.45	\$50.40	\$19.62	\$42.01

This table is meant as a guide only. Please refer to the notes regarding running cost assumptions and how values have been calculated on the previous page. Always double check figures based on your own use.

The weekly running costs are calculated based on the Novo, during cooler months, operating two hours in the morning and three hours in the evening—a total of five hours use each day.



Please note

All Rinnai gas fires require electricity to run—electricity costs have not been factored into the running costs.

The 45 kg LPG bottle hours do not include running times of other gas appliances in use, for example a gas water heater or a gas hob.

Rinnai.co.nz

Tel: 0800 746 624

<http://www.youtube.com/rinnainz>

<http://facebook.com/rinnainz>