

Rinnai

Smart Port – Wi-Fi Kit

For Residential and
Light Commercial Air Conditioners
Operating & Installation Manual

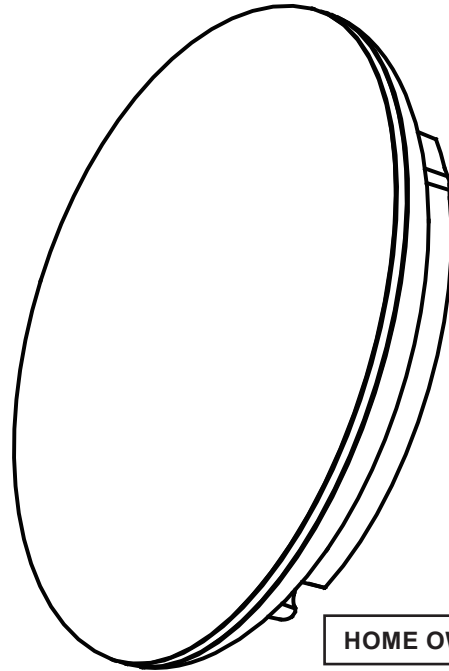

APPLY SPARE
QR CODE
LABEL

HOME OWNER TO RETAIN FOR FUTURE REFERENCE

This page is intentionally blank

Congratulations on the purchase of a Rinnai Smart Port which is compatible with selected Rinnai and Brivis Air Conditioners.

Terms and Conditions

Please read Terms and Conditions carefully before proceeding with downloading the App.

Disclaimer

IMPORTANT NOTICE: This document is a guide only. Laws, regulations and industry standards can vary between States and Territories. Accordingly, this guide must be read in conjunction with, and subject to, all laws, regulations and industry standards applicable in the State or Territory in which the products are installed. You must ensure that the installation of the products will comply with those laws, regulations and standards, and that the products recommended to customers are fit for the purpose for which they are intended.

Privacy Notification

Rinnai Australia Pty Ltd will collect personal information when warranty and maintenance registration forms are completed. This personal information is collected under the guidance of the Privacy Information Protection Act 1998.

The purpose of collecting this information is to:

- process customer requests for us to provide service activities;
- register purchases of equipment for warranty;
- register requests for a survey/quotation for heating, ventilation, and air conditioning goods and services.

The intended recipients of the information are:

- employees of Rinnai.
- federal and state governments who may require the information for administration purposes.

While the supply of the information is voluntary, if our customers cannot, or do not wish to provide the information sought, the company may not be able to provide the services requested. If information has already been provided, an application can be made for access or amendment of that information, or to request that it not be used. Customers have a right of access to, and correction of, the information concerning them in accordance with the relevant procedures under the Act.

Enquiries concerning this matter can be addressed to the Business Practices Officer using the 'Contacts' on page 36.

Shall

Indicates a mandatory requirement of this manual.

Should

Indicates a recommended requirement of this manual.

Any deviations from these instructions may, at the discretion of the manufacturer, void the warranty. As a result, the customer and/or installer may be charged a fee for non-product warranty related call outs. Also note that failure to comply with these instructions may preclude company service personnel from being able to service the device.

General Compatibility

All the following Rinnai (and Brivis) branded Residential and Light Commercial products that have a “CN40” terminal on the PCB of the INDOOR UNIT, are compatible for use with the Smart Port accessory module.

- Ducted Inverter
- Cassette Inverter
- Slim Ducted Multi Inverter
- Compact Cassette Multi Inverter

For multiple INDOOR UNIT installations, one Smart Port is required for each INDOOR UNIT.

Contact Rinnai Technical Support for further information.

WARNINGS AND IMPORTANT INFORMATION



READ ALL INSTRUCTIONS BEFORE USING THE DEVICE AND APP.

Always comply with the following precautions to avoid dangerous situations and to ensure optimum performance. Failure to carefully read and follow all instructions in this manual can result in equipment malfunction, property damage, personal injury and/or death.

DANGER: Indicates an imminently hazardous situation which, if not avoided, will result in personal injury or death.

WARNINGS: Indicates a potentially hazardous situation which, if not avoided, could result in personal injury or death.

CAUTIONS: Indicates a potentially hazardous situation which, if not avoided, could result in minor or moderate injury or damage to the appliance. It may also be used to alert against unsafe practices.



Read all the safety precautions carefully before installing the unit.

Outlined below are important safety guidelines which must be followed.

Applicable system: iOS and Android. Recommended iOS 9.0 and above, Android 4.0 and above.

Due to special circumstances which may occur, not all Android and iOS systems are compatible with the App. The manufacturer will not be held responsible for any incompatibility issues.

The manufacturer will not be held liable for any issues and problems caused by the internet, Wi-Fi router and Smart devices. Please contact the original provider for further help.

Wireless safety strategy

- Smart Port only supports WPA-PSK/WPA2-PSK encryption and non encryption.



Smart Phone camera needs to be 5 million pixels or above to ensure QR code scans clearly.

Depending on your network, time-out may occur. Therefore, it may be necessary to repeat network configuration.



This equipment has been tested and found to comply with the limits for a Class B digital device, pursuant to Part 15 of the FCC Rules. These limits are designed to provide reasonable protection against harmful interference in a residential installation. This equipment generates, uses and can radiate radio frequency energy and, if not installed and used in accordance with the instructions, may cause harmful interference to radio communications. However, there is no guarantee that interference will not occur in a particular installation. If this equipment does cause harmful interference to radio or television reception, which can be determined by turning the equipment off and on, the user is encouraged to try to correct the interference by one or more of the following measures:

- Reorient or relocate the receiving antenna.
- Increase the separation between the equipment and receiver.
- Connect the equipment into an outlet on a circuit different from that to which the receiver is connected.
- Consult the dealer or an experienced radio/TV technician for help.



- The supplied remote control is used to configure and connect to Wi-Fi.
- The supplied remote should be retained in the event the connection needs to be established or set up needs to be repeated.
- The supplied remote control can also be used to operate the system if the original system was supplied with a remote control. Point remote control towards the Smart Port Receiver.



A NOTE ON ILLUSTRATIONS

The illustrations used in this manual are for explanatory purposes only and the shape of your unit may vary slightly from that which is shown in this manual.

- The 'Nethome Plus' App configuration and user screens are subject to change.



With our policy of continuous improvement, we reserve the right to change, or discontinue at any time, specifications, design, illustrations and content without notice. Pictures for illustration purposes only.

TABLE OF CONTENTS

1.0	Specifications	8	7.0	Using The App	30
2.0	Smart Port Kit	8	8.0	Special Functions	31
2.1	Kit Contents.	9			
2.2	Dimensions	10			
3.0	Installation	10			
3.1	Smart Port Wiring	10			
3.2	Location	10			
3.3	Smart Port Without Wired Controller	11			
3.4	Smart Port With Wired Controller	14			
4.0	Download and Install App	18			
5.0	User Registration	19			
6.0	Network Configuration	20			
6.1	Configuration – Android	21			
6.2	Configuration – iOS	25			
					36

1.0 SPECIFICATIONS

Model	WF-60A1
Standard	IEEE802.11b/g/n
Antenna Type	External omnidirectional Antenna
Frequency	Wi-Fi: 2.4G
Maximum Transmitted Power	15dBm Max
Operation Temperature	0°C~45°C/32°F~113°F
Operation Humidity	10%~85%
Power Input	DC 5V/300mA
Remote Control Battery	Rated Voltage - 3.0V (2 x AAA 1.5 Volt Batteries)

2.0 SMART PORT KIT

Do not install the Smart Port in areas covered in heavy oil, vapor or sulphur gases, otherwise this product will react and may lead to system malfunction.

Kit Contents – See Figure 1

No.	Description		Qty
1	Smart Port (Receiver)		1
2	Looms	CN2	–
3		Extension (6m)	PN: B026005
4		CN40 DRCi	PN: B080175
5	Remote Control for Setup		1
6	Smart USB		1
7	Smart Port Unique ID QR Label		1
8	Screws (M4X20)		3
9	Wall Plugs		3
10	AAA Batteries (1.5 Volts)		2
11	Operating and Installation Manual		1

Please check that all parts have been supplied.

2.1 KIT CONTENTS.



Figure 1. What's in the box

2.2 DIMENSIONS

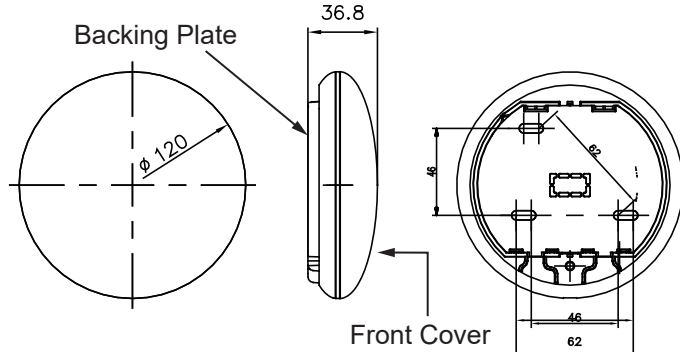

Figure 2. Dimensions

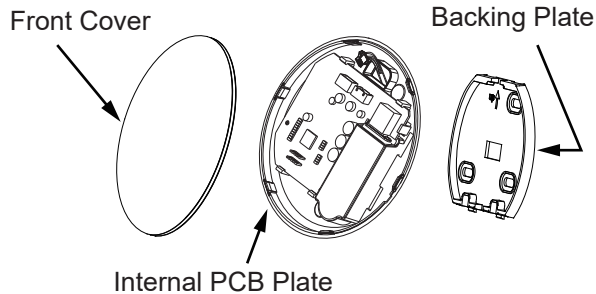

Figure 3. Components

3.0 INSTALLATION

3.1 SMART PORT WIRING

Determine wiring configuration of your Smart Port before commencing.

For installations without wired controller, refer to Section 3.3.

For installations with wired controller, refer to Section 3.4.

3.2 LOCATION

- Indoors only
- Internal plaster wall or ceiling

The Smart Port shall be positioned in a waterproof environment within 10m of your wireless router (where applicable) to ensure reliable communication. If this distance is more than ten meters the transmitting signal may be predisposed to interruption. Please consult your installer in the first instance if this issue is identified.

The environment must not exceed a temperature of 70°C and relative humidity of 85%.

 **IMPORTANT** The Smart Port **MUST NOT** be installed inside any appliance cabinet as this will adversely affect the Wi-Fi connection. Do not position outside or under floor.

3.3 SMART PORT WITHOUT WIRED CONTROLLER

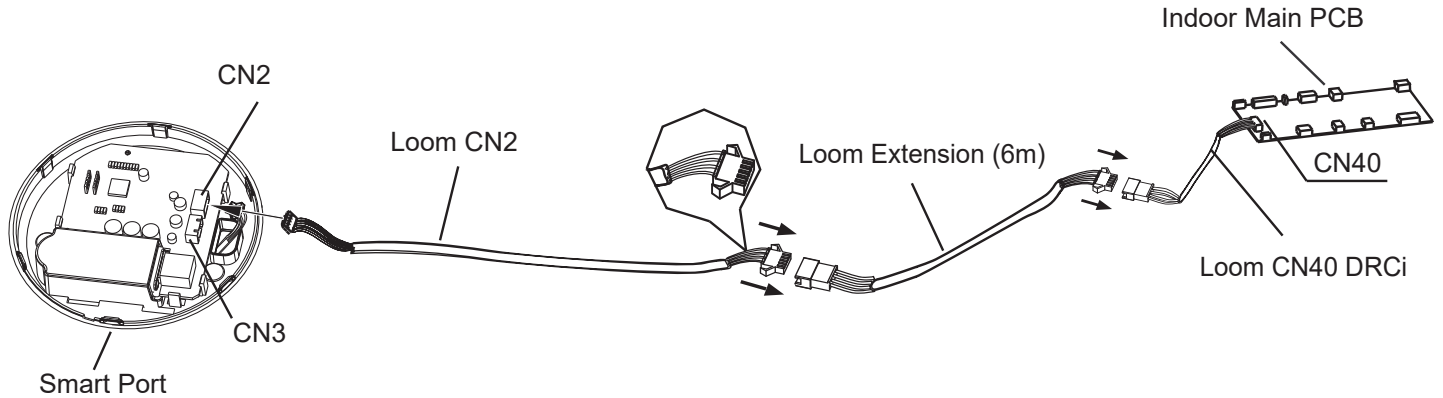

Figure 4.

Fit the looms supplied as shown in Figure 4.

One side is connected into port CN40 on the indoor unit main PCB. The other loom is plugged into CN2 on the Wi-Fi Smart Port terminal.

If you require more than a 6m loom extension, you can order an additional 6m extension from the manufacturer. Rinnai Part Number B026005.

Assembly of Smart USB

1. Carefully remove the Backing Plate by inserting a slot screwdriver into the slots as shown in Figure 5 in the lower part of the Smart Port (2 places), and lever up to remove the Smart Port base.

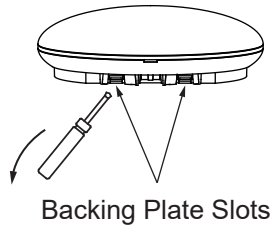

Figure 5.

2. Insert Smart USB into the main PCB of the Smart Port. Refer to Figure 6.

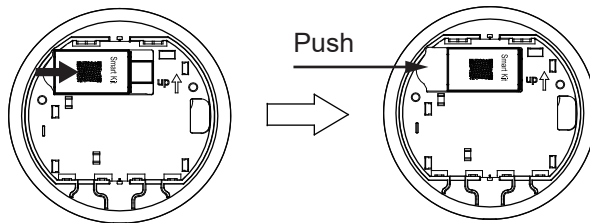

Figure 6.

3. Determine path of Looms to exit Backing Plate.
4. For rear exit of Backing Plate, remove and discard the perforated rectangle Knock-Out Plate as shown in Figure 7.

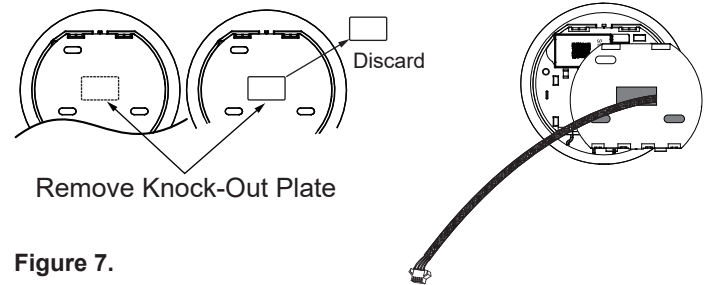

Figure 7.

5. For above or below Backing Plate, see route options as shown in Figure 8.

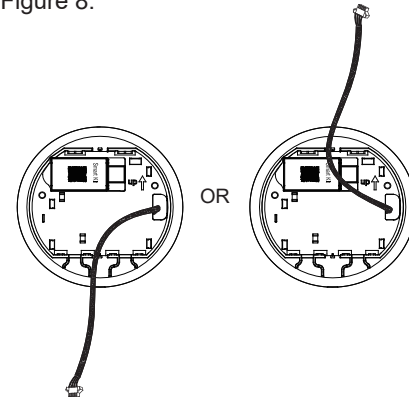

Figure 8.

6. Fasten the Backing Plate of the Smart Port
- For exposed mounting, fasten the Backing Plate with the screws and plugs supplied if required. Refer to Figure 9.

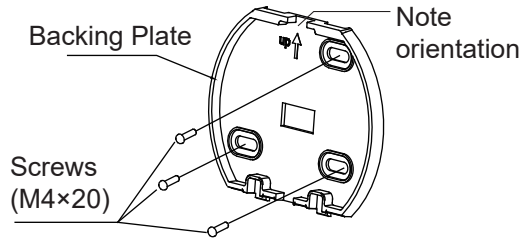

Figure 9.

Wiring the Smart Port

- A. For exposed wire mounting, two outlet positions

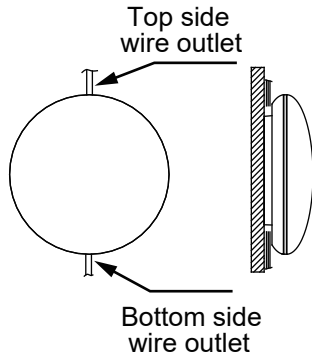

Figure 10.

- B. Shielded Wiring

Wiring through the wall

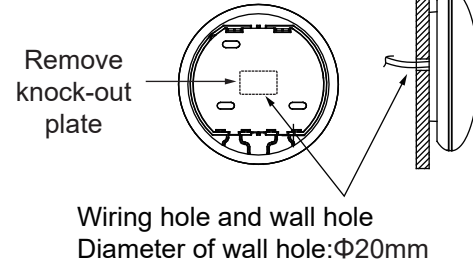

Figure 11.



Avoid water entering into the Smart Port. Trap loom and then putty to seal the connection wires during installation. See Figure 12. When installing, save a length of loom for convenience to remove the Smart Port during maintenance.

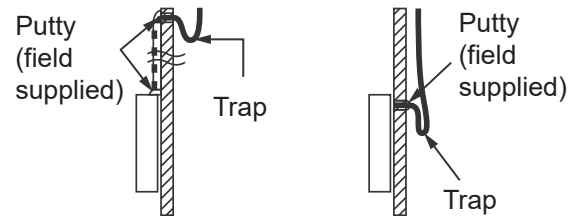

Figure 12.

3.4 SMART PORT WITH WIRED CONTROLLER

If you want to use both the wired controller and the Wi-Fi control at the same time, you can use the CN3 port on the Smart Port terminal to connect the wired controller as shown in Figure 13.

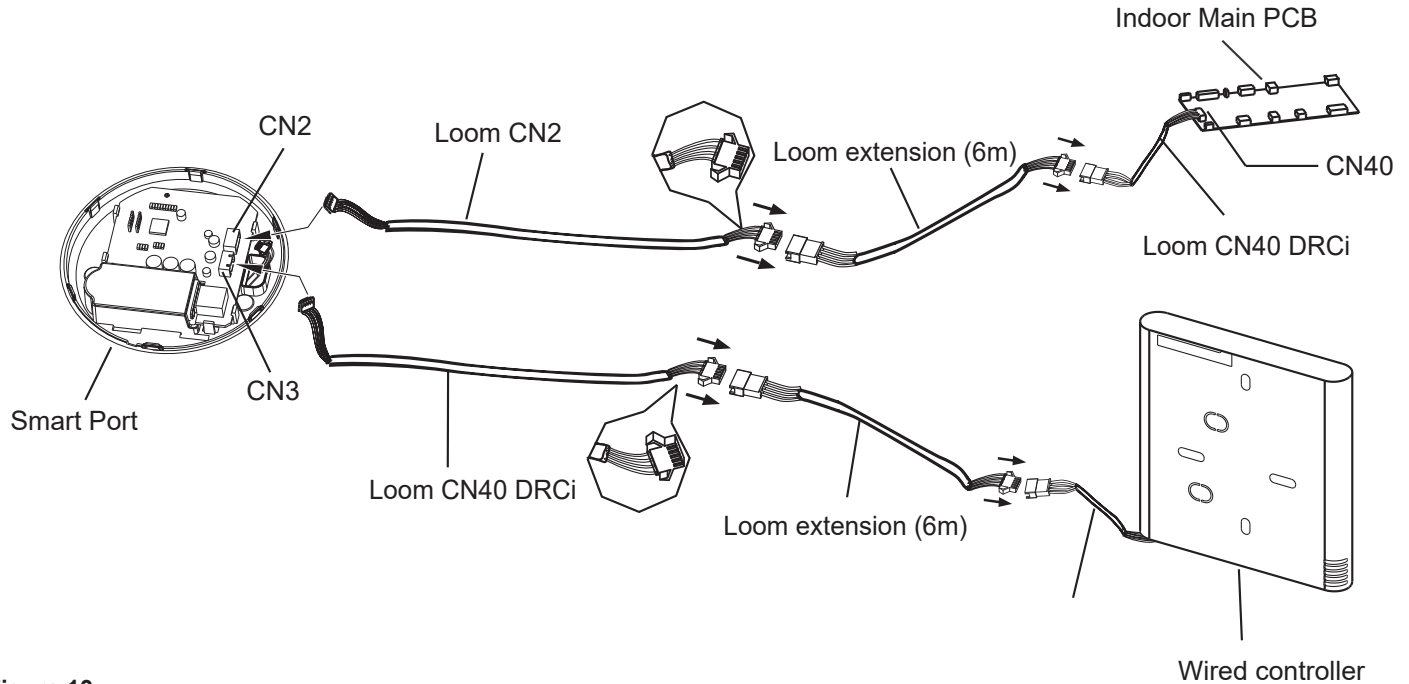

Figure 13.

Assembly of Smart USB

1. Carefully remove the Backing Plate by inserting a slot screwdriver into the slots as shown in Figure 14 in the lower part of the Smart Port (2 places), and lever up to remove the Backing Plate.

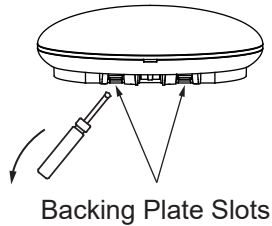

Figure 14.

2. Insert Smart USB into the main PCB of the Smart Port. Refer to Figure 15.

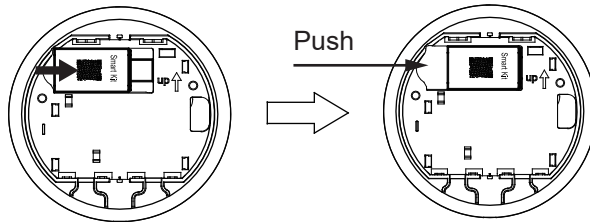

Figure 15.

3. Remove the front cover by inserting a screwdriver into the slot as shown in Figure 16, and slowly and carefully lever down to remove.

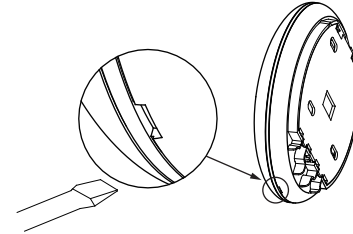

Figure 16.

4. Install Loom CN40 DRCi (supplied) into CN3 port.
 - Use the CN40 loom to connect the wired controller to the CN3 terminal of the Smart Port. See Figure 17.

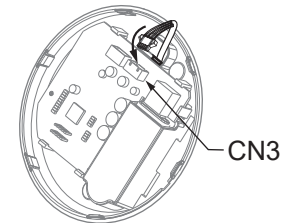

Figure 17.

5. Determine path of Looms to exit Backing Plate.
6. For rear exit of Backing Plate, remove and discard the perforated rectangle Knock-Out Plate as shown in Figure 18.

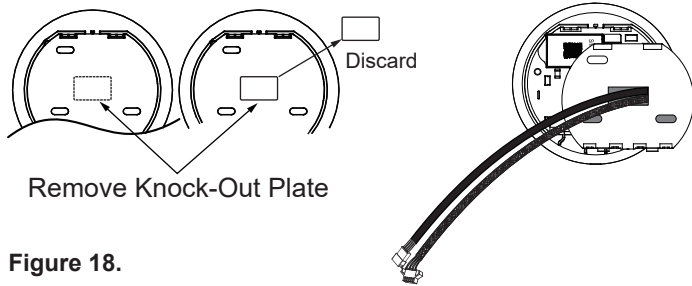

Figure 18.

7. For above or below Backing Plate, see route options as shown in Figure 19.

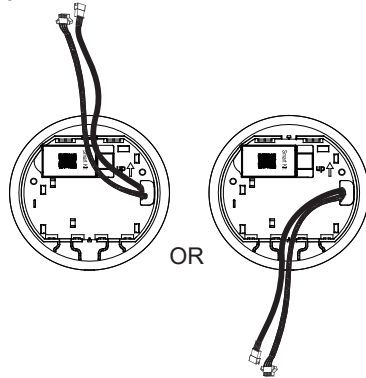

Figure 19.

8. Fasten the Backing Plate of the Smart Port
 - For exposed mounting, fasten the Backing Plate on the wall with the screws and plugs supplied. Refer to Figure 20.

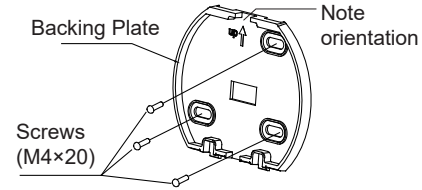

Figure 20.

Wiring the Smart Port

- A. For exposed mounting, two outlet positions

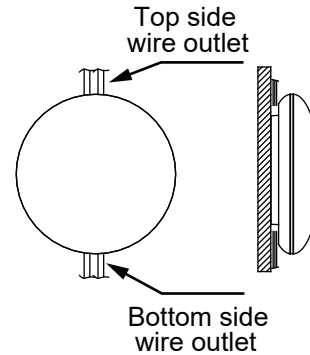

Figure 21.

B. Shielded Wiring

Wiring through the wall

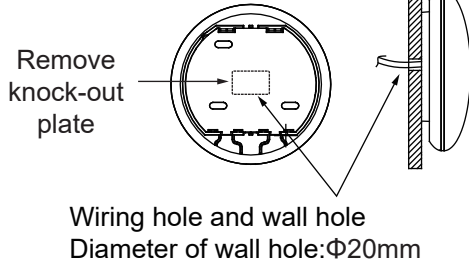

Figure 22.

9. Reattach the front cover

- After aligning the front cover, carefully clip onto Internal PCB Plate and taking care to avoid clamping the loom during installation. Refer to Figure 24.

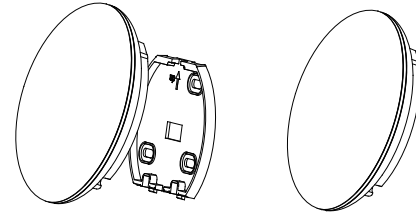

Figure 24.



Avoid water entering into the Smart Port. Trap loom and then putty to seal the connection wires during installation. See Figure 23. When installing, save a length of loom for convenience to remove the Smart Port during maintenance.

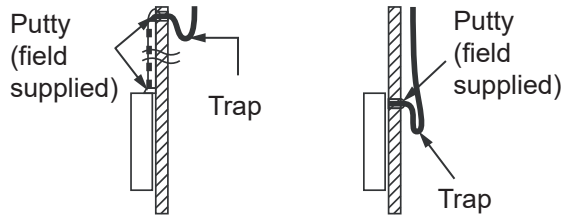
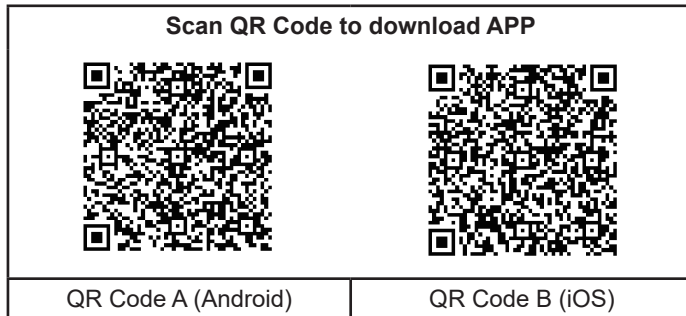

Figure 23.

4.0 DOWNLOAD AND INSTALL APP

Quick Start Guide

1. Download App 'Nethome Plus'
2. In settings, Turn off 'Mobile data'
3. Open 'Nethome Plus' App
4. On the Remote Control, press 'LED' 7 times (No audible beep or display of AP)
5. Once configuration is complete, turn on mobile data



Android Phone Users

Android Phone users: scan QR Code A or go to Google Play, search 'Nethome Plus' app and download APP.

iPhone Phone Users

iPhone Users: scan QR Code B or go to App Store, search 'Nethome Plus' app and download APP.

5.0 USER REGISTRATION

- Download App 'Nethome Plus'

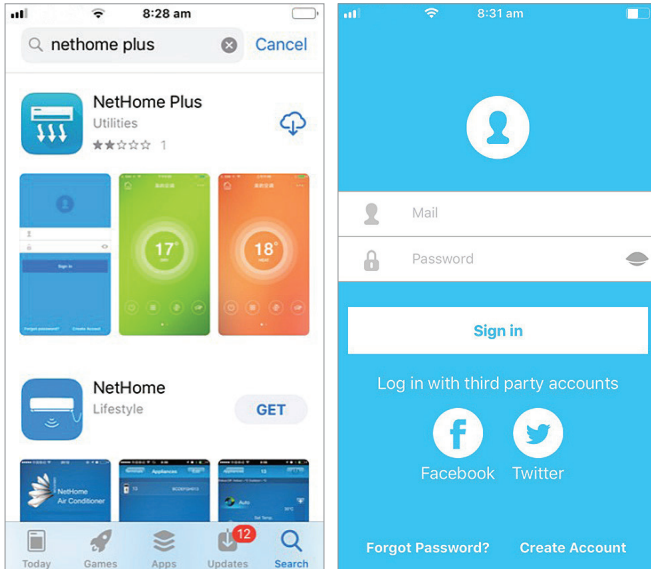

Please ensure your mobile device is connected to the Wi-Fi router. Make sure the Wi-Fi router is connected to the internet before completing user registration and network configuration.

- If you do not have an account Click 'Create Account'.

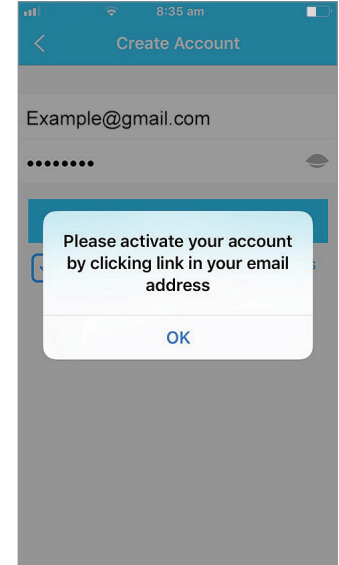
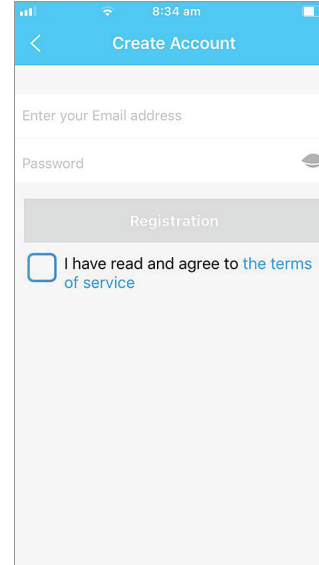

- Click 'OK'. and proceed to your email account

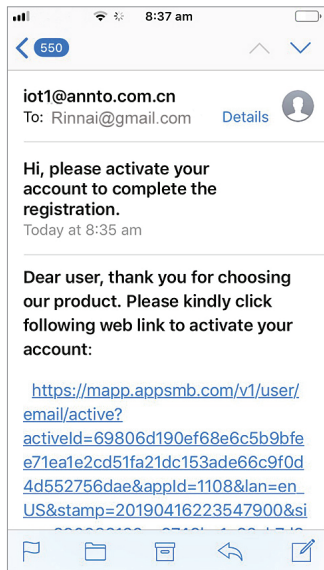

- An email will be sent for you to activate your account to complete your registration.

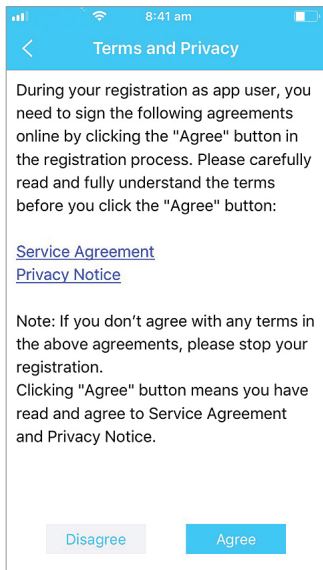

- Follow prompts and read carefully before you agree to the terms and conditions.

6.0 NETWORK CONFIGURATION



You must select your Wi-Fi network for successful registration. Turn off your 'mobile data'.

Make sure the Android or iOS device connected to your Wi-Fi is functioning well and can connect back to your original Wi-Fi network automatically.

Enter the AP mode description.

Use the Remote Controller to enter AP mode. Aim the remote control at the Smart Port, then press the L.E.D 'Follow Me' button seven times within 3 minutes. The indicator L.E.D of the Smart Port will flash (indicating AP mode).



When your Air Conditioner (AC) enters into 'AP' mode, the air-conditioning remote controller can't control it. It is necessary to finish network configuration or power the AC again in order to control it. Alternatively, you need to wait 8 minutes to let the AC quit 'AP' mode automatically.

6.1 CONFIGURATION – ANDROID

Using Android device to do network configuration

1. Make sure your mobile device has already been connected to the Wi-Fi network which you want to use. Also, you need to forget other irrelevant Wi-Fi networks in case it influences your configuration process.
2. Disconnect the power supply of AC.
3. Connect the power supply of AC, and continuously press the L.E.D. 'Follow Me' button seven times in 3 minutes or until the AC displays 'AP'.
4. Some AC models do not need Step 2 to be in AP (where applicable). In some instances AP will not display on all unit heads.

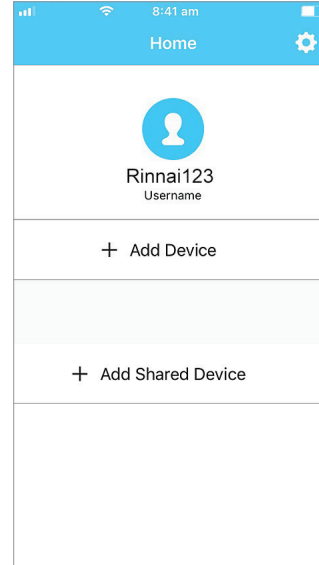

1. Press + 'Add Device'.

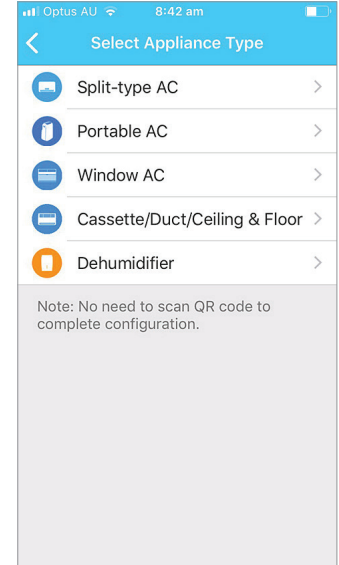

2. Select your appliance.

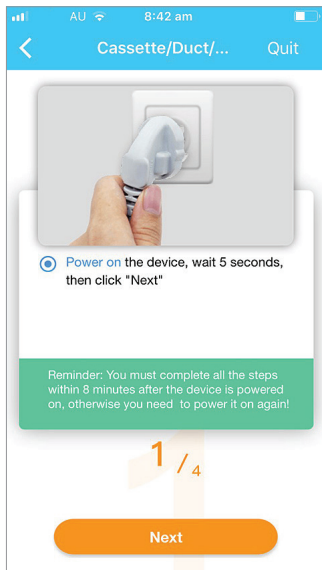

3. Power on your appliance and wait 5 seconds then press 'Next'.

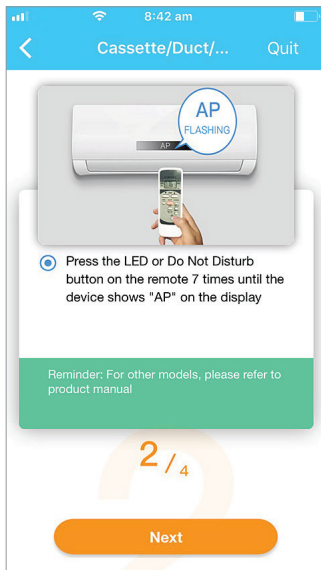

4. Press the LED or Do Not Disturb button on the remote 7 times until 'AP' flashes on the display.

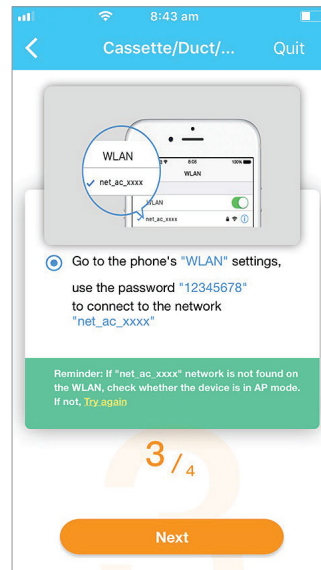

5. Go to your phone's 'WLAN' settings.

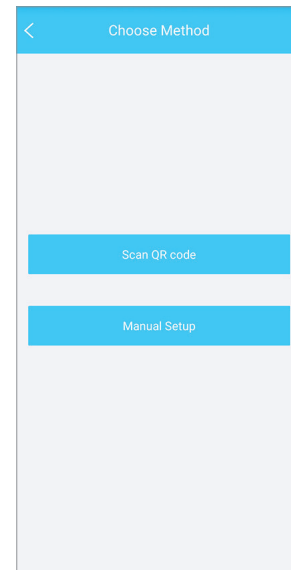

6. Scan Smart Port Unique ID QR Label (Item 7) supplied in box.

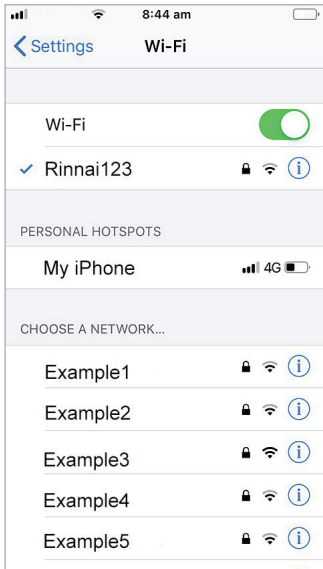

7. Select your own Wi-Fi network, for example Rinnai123 (figure above for reference only).
8. Enter your own Wi-Fi router password and click OK.

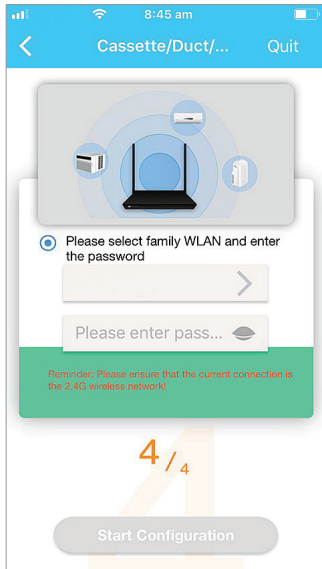

9. Select your 'WLAN' and enter the password.

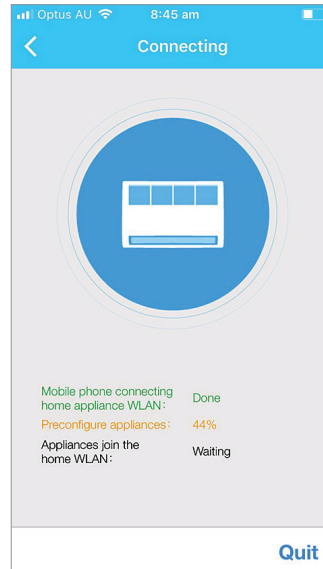

10. Mobile is connecting to WLAN.

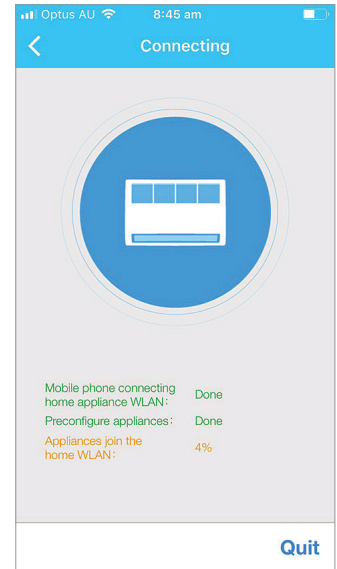

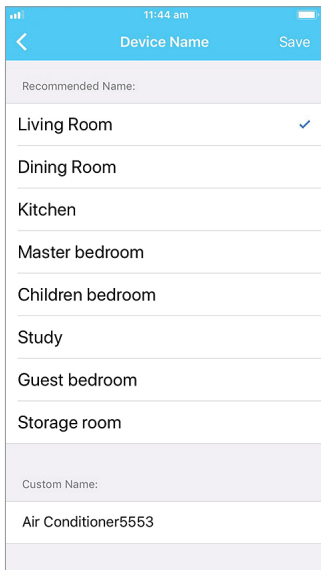

11. Configuration is successful when you can see that the device is listed. To activate the appliance, choose the appliance room area (e.g. Living Room) and select 'Save'.

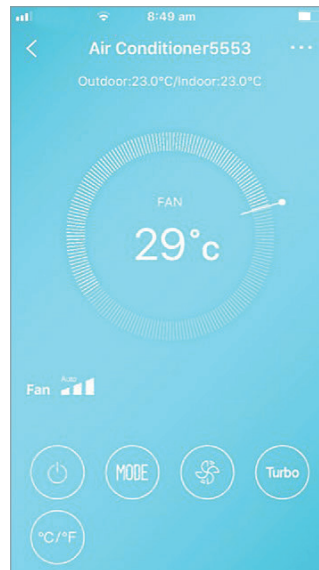
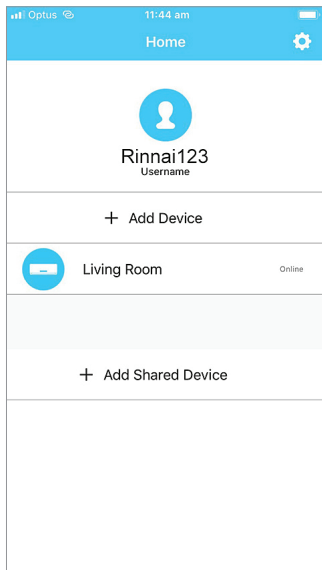

12. The App is now fully configured for use.

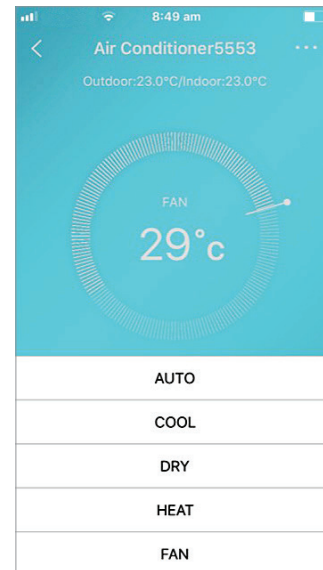

13. You can now operate your system from anywhere with an internet connection.

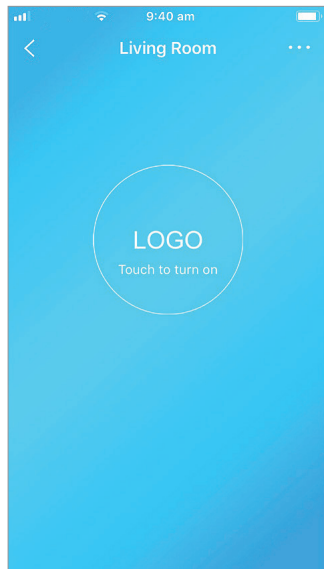

14. Touch to turn on.

6.2 CONFIGURATION – IOS

Using iOS device to do network configuration

1. Make sure the device Wi-Fi function is active, set to automatically connect to the (home) network, and connected to this network throughout the configuration process.
2. Disconnect the AC power supply (some units).
3. Connect the AC power supply and press the L.E.D. 'Follow Me' button seven times in 3 minutes or until the AC displays 'AP'.



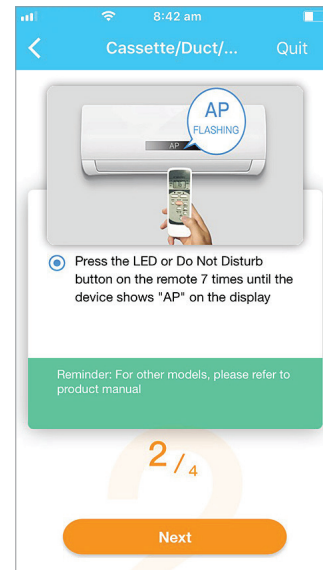
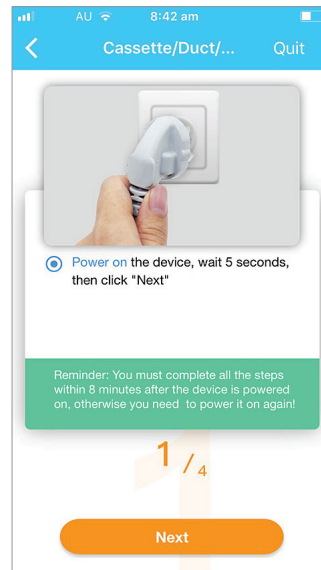
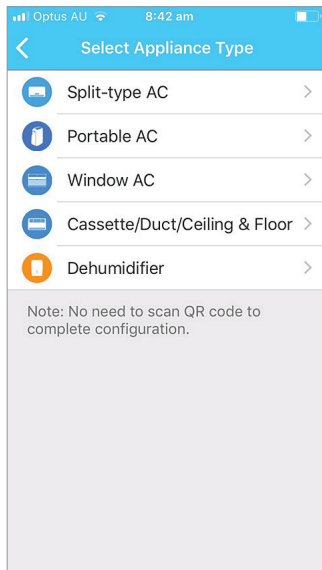
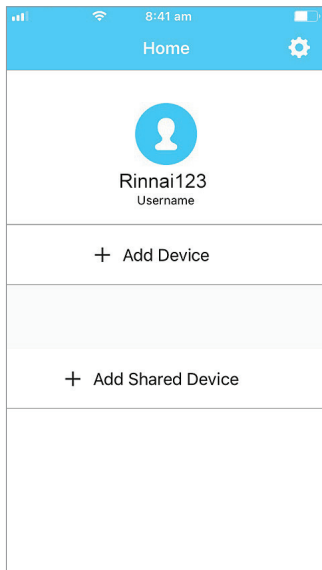

1. Press + 'Add Device'.
2. Select your appliance.
3. Power on your appliance and wait 5 seconds then press 'Next'.
4. Press the LED or Do Not Disturb button on the remote 7 times until 'AP' flashes on the display.

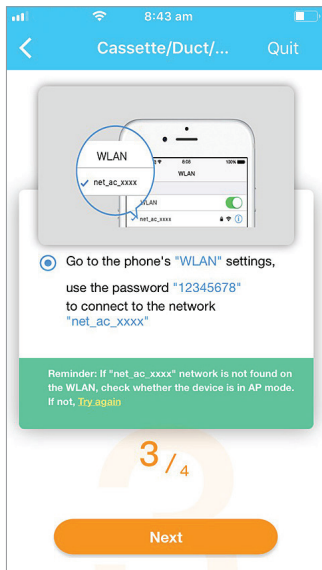

5. Go to your phone's 'WLAN' settings.

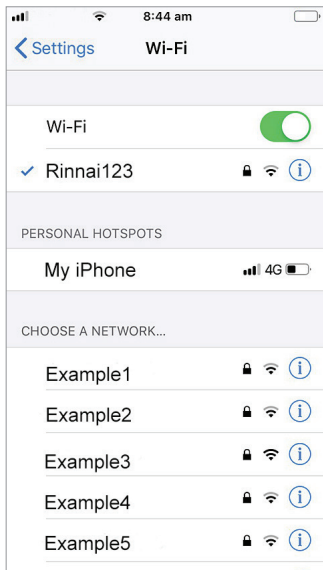

6. Select your own Wi-Fi network, for example Rinnai123 (figure above for reference only).

7. Enter your own Wi-Fi router password and select 'OK'.

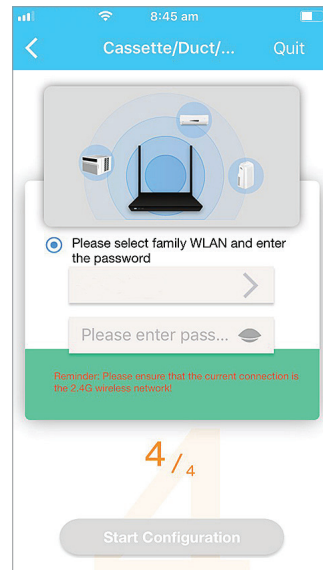

8. Select your 'WLAN' and enter the password.

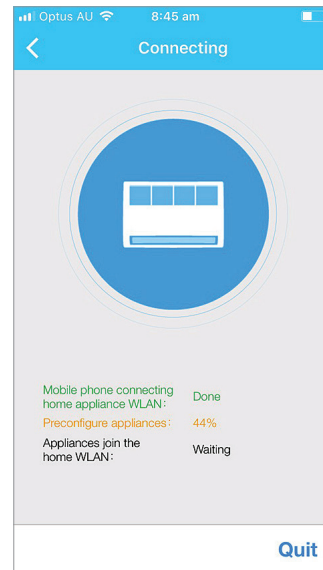

9. Mobile is connecting to WLAN.

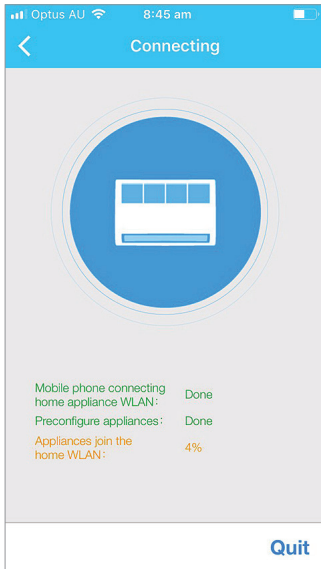

10. Mobile is almost completed connecting to WLAN.

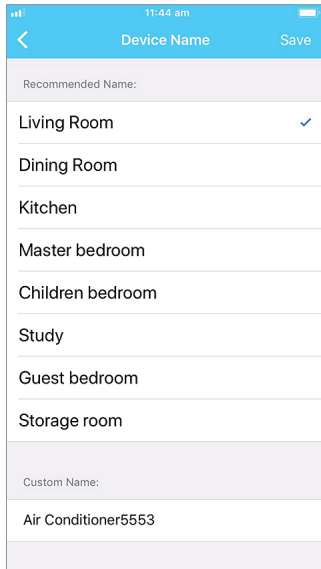

11. Configuration is successful when you can see that the device is listed.

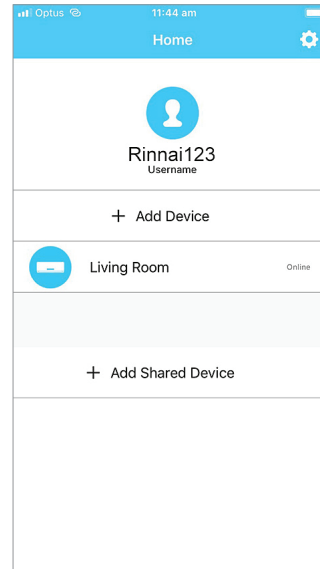

12. To activate the appliance, choose the appliance room area (e.g. Living Room) and select 'Save'.

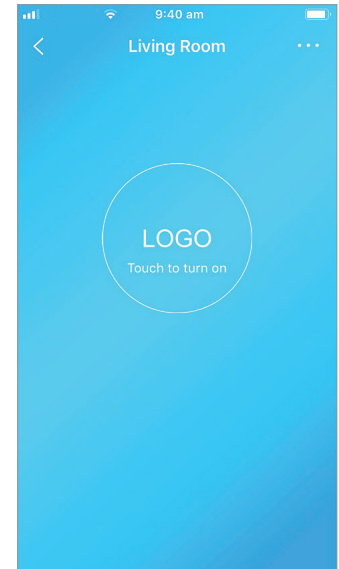

13. Touch to turn on.

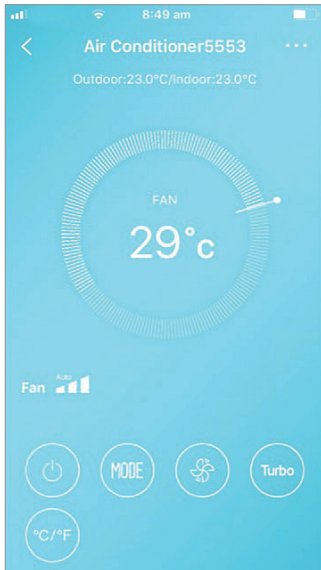

14. Controls are now visible and ready for use.

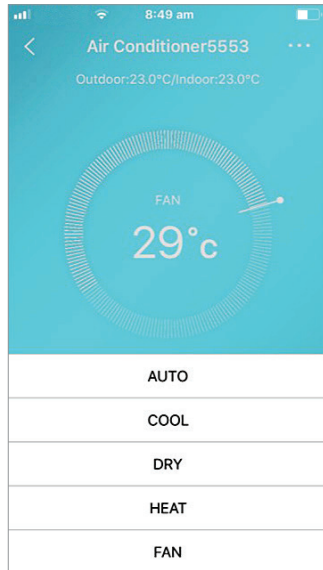

15. You can now operate your system from anywhere with an internet connection.

7.0 USING THE APP

- Turn on mobile data and ensure both your mobile device and air conditioner are connected to the Internet before using app to control the air conditioner via internet, please follow the next steps:

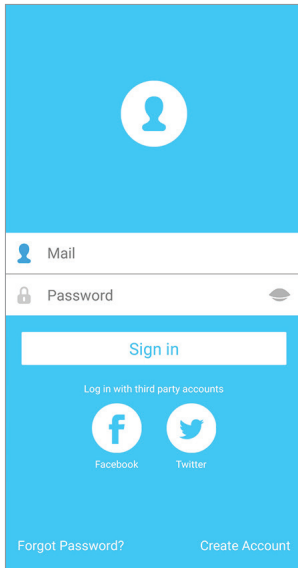

1. Type your account and password and sign in.

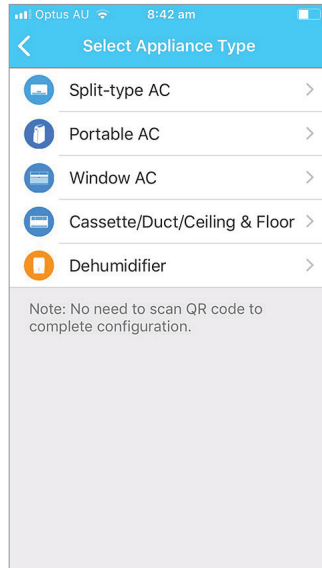

2. Select your appliance.

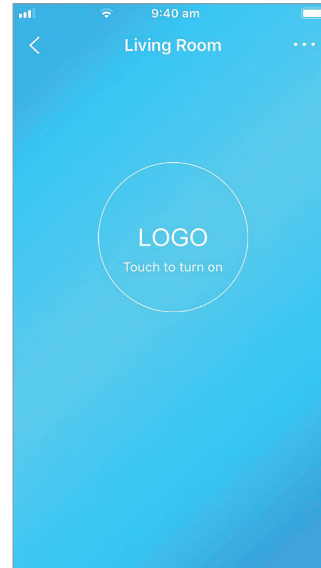

3. Touch to turn on.



4. The user can control the AC on/off status, operation mode, fan speed, temperature, etc.



Depending on your specific air conditioning system, some functions may not be controllable.

8.0 SPECIAL FUNCTIONS

Including: Timer on, Timer off, 8°C Heat, Sleep, Check.



If the air conditioner does not support the above functions, they will not be controllable.

■ Timer on/ Timer off

User can schedule daily to turn air conditioner ON/OFF at any specific time of day during the week.

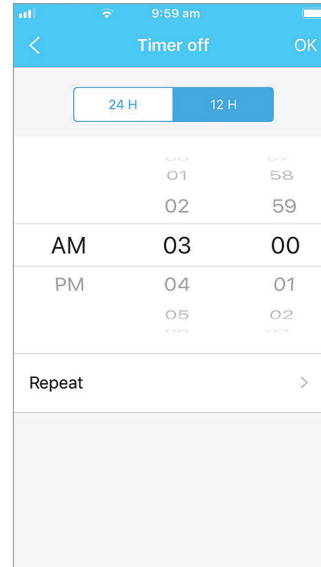
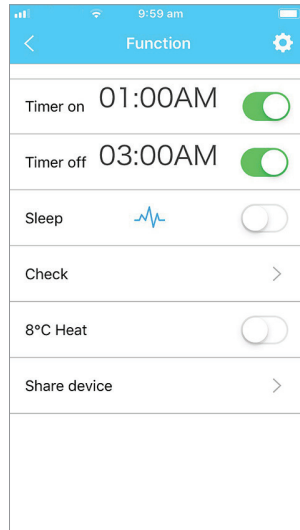
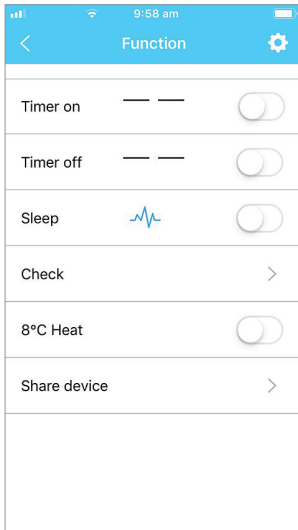

To access timer OFF or timer ON screen, select the associated time on Function Screen (e.g. 01:00AM). Press Repeat Function if you would like to program various days of the week to this time..

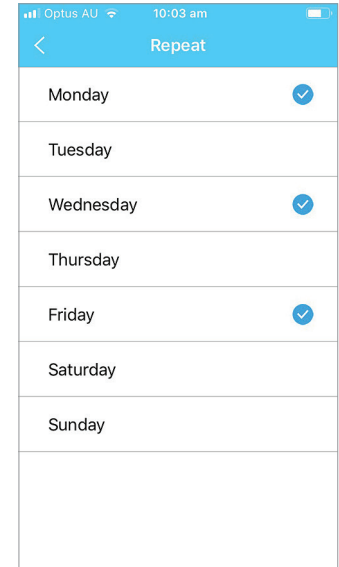

Select nominated days and press < (Back) to save and exit.

■ 8°C Heating

8°C Heat by one-click. This function is currently not available.

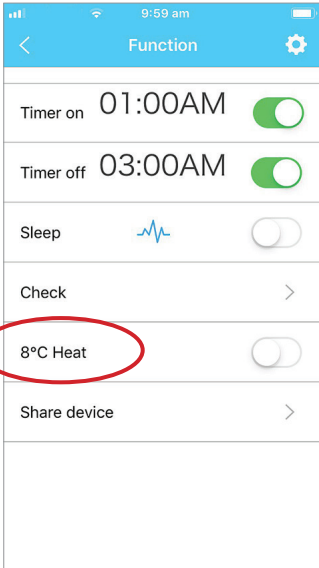

This function is not available for Residential Light-commercial units.

■ Sleep

User can customise their own comfortable sleep by setting an overnight target temperature. To access Sleep, system must already be operating in heating or cooling mode.

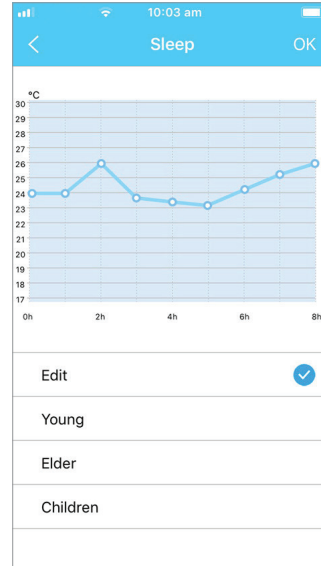

■ Check

User can simply check the Air Conditioner running status with this function. When viewing this report, it displays a Check list (see below). Select Detail for more information on each item.

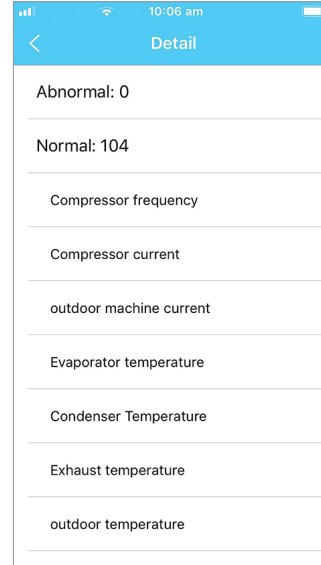
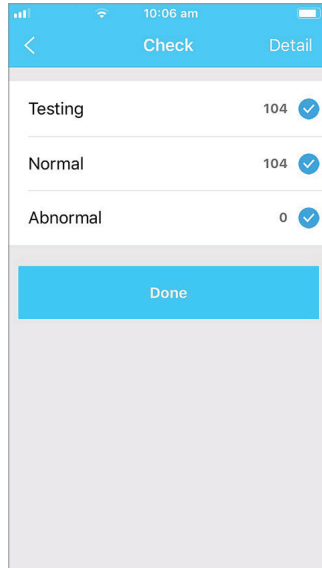
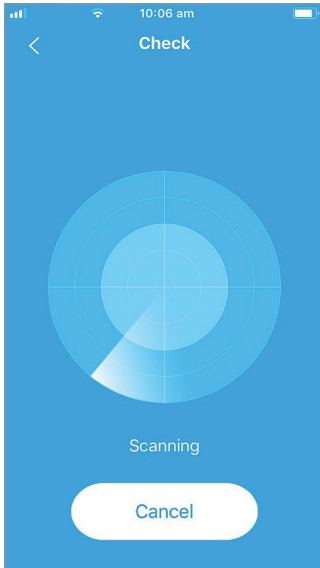

NOTE For some units, not all the functions of the App are available.



- This device complies with Part 15 of the FCC Rules and RSS 210 of Industry & Science Canada. Operation is subject to the following two conditions: (1) this device may not cause harmful interference, and (2) this device must accept any interference received, including interference that may cause undesired operation.
- Only operate the device in accordance with the instructions supplied. This device complies with FCC and IC radiation exposure limits set forth for an uncontrolled environment. In order to avoid the possibility of exceeding the FCC and IC radio frequency exposure limits, human proximity to the antenna shall not be less than 20cm (8 inches) during normal operation.
- Changes or modifications not expressly approved by the party responsible for compliance could void the user's authority to operate the equipment.

9.0 WARRANTY

TERMS OF WARRANTY – AUSTRALIA

Rinnai Australia Pty. Ltd. ABN 74 005 138 769, 100 Atlantic Drive, Keysborough VIC 3173.

NOTICE TO CONSUMERS UNDER AUSTRALIAN CONSUMER LAW

Our goods and services come with guarantees that cannot be excluded under the Australian Consumer Law.

For a major failure with a good, you are entitled to a replacement or refund and compensation for any other reasonable foreseeable loss or damage. If the failure does not amount to a major failure and if the goods fail to be of acceptable quality, you are also entitled to have the goods repaired or replaced.

For a major failure with the service, you are entitled to cancel your service contract with us and obtain a refund for the unused portion, or to compensation for its reduced value. You are also entitled to be compensated for any other reasonably foreseeable loss or damage. If the failure does not amount to a major failure you are entitled to have problems with the service rectified in a reasonable time and, if this is not done, to cancel your contract and obtain a refund for the unused portion of the contract.

The benefits provided by this Warranty are in addition to any other rights and remedies available to a consumer under the Australian Consumer Law and any other law which may apply to the goods and or services.

WARRANTY: Rinnai Smart Port

This product is warranted for a period of one (1) year from the date of purchase, in accordance with the Terms and Conditions of Warranty detailed below.

IMPORTANT – TO BE READ IN CONJUNCTION WITH THE TERMS AND CONDITIONS OF WARRANTY

- The fitness for purpose of the Rinnai Smart Port and ensuring suitable Wi-Fi connectivity is the sole responsibility of the Qualified Installer and or Purchaser.
- The Smart Port must be installed by a suitably Qualified Installer in accordance with local and national wiring codes, otherwise the warranty will be void.
- Always refer to the Installation and Owner's Manuals to ensure the correct installation and operation procedures have been followed.
- The Smart Port is to be installed indoors only; warranty excludes damage caused by the elements such as rain, wind, lightning, or harmful environmental conditions.
- Warranty on the Smart Port is separate from the warranty on associated appliances, equipment and ancillary components.
- For full Terms and Conditions, go to the Rinnai website, www.rinnai.com.au



Rinnai

Rinnai Australia Pty. Ltd.

ABN 74 005 138 769

100 Atlantic Drive, Keysborough, Victoria 3173

P.O. Box 460, Braeside, Victoria 3195

AU45204

Rinnai has a Service and Spare Parts network with personnel who are fully trained and equipped to give the best service on your Rinnai appliance. If your appliance requires service, please call our National Help Line.

With our policy of continuous improvement, we reserve the right to change, or discontinue at any time, specifications or designs without notice.

Product Sales & Service National Help Line

Tel: **1300 555 545*** Fax: **1300 555 655**

*Monday to Friday, 8.00am to 5.30pm EST

For further information visit www.rinnai.com.au
or email enquiry@rinnai.com.au